

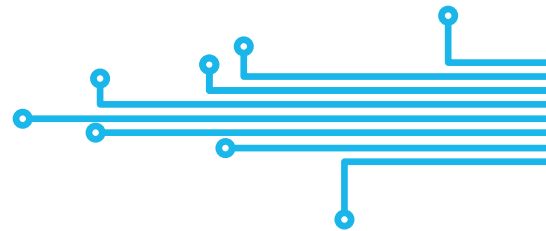

SGX

SENSORTECH

An Amphenol Company



PS1-CO-1000-MOD

Carbon Monoxide Module Datasheet

Working temperature: $-40\text{ }^{\circ}\text{C} - 55\text{ }^{\circ}\text{C}$

In the indoor environment of the home under normal temperature and humidity, service life up to 10 years

Small size | Low cost | Long life | Fast response | High accuracy | Low power consumption



Quality, Safety, Responsibility

Product note

The PS1-MODs series carbon monoxide module has many high-precision detection technologies from Sensor and circuit team together. The sensor uses the world's smallest solid polymer sensor. It can replace our nose to sniff out the gas concentration accurately, and realize accurate gas detection. The module uses UART digital output, make easy for customer use, eliminating the need for customers to understand the sensor application and the tedious work of calibration.

Features

- High accuracy and long life
- Fast response speed, fast return to zero, plug and play
- Good anti-toxicity
- Easy to use, UART digital signal output
- German sensors are durable and reliable
- Excellent accuracy, repeatability, linearity and consistency
- Zero drift
- Strong anti-electromagnetic interference ability
- With fixed mounting holes for easy installation
- Sleep design for low power IOT applications
- Independent temperature and humidity digital sensor output
- RoHS environmental design

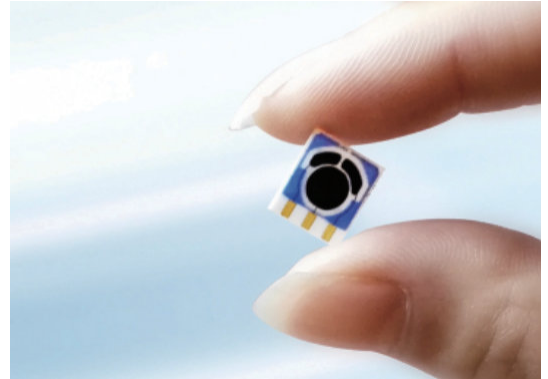

Application

- Early warning and monitoring of fire
- Early warning of automobile lithium battery failure (fire)
- Security / fire alarm



Cross Sensitivity

Gas	Formula	Test Concentration	Sensor Reading
Acetylene	C ₂ H ₂	80.3 ppm	0 ppm
Ammonia	NH ₃	50 ppm	0 ppm
Benzene	C ₆ H ₆	986.5 ppm	0 ppm
Carbon monoxide	CO	100 ppm	100 ppm
Ethanol	C ₂ H ₆ O	104.2 ppm	0 ppm
Ethylene oxide	C ₂ H ₄ O	14.4 ppm	0 ppm
Formaldehyde	HCHO	1 ppm	0 ppm
Hydrogen	H ₂	1000 ppm	500 ppm
Isobutene	C ₄ H ₈	300 ppm	0 ppm
Methane	CH ₄	3.04% vol	0 ppm
Methane	CH ₄	5000 ppm	0 ppm
Nitrogen dioxide	NO ₂	50 ppm	0 ppm
Ozone	O ₃	50 ppm	0 ppm
Trichloroethylene	CH ₂ CL ₂	30 ppm	0 ppm

Note:

- 1) The above interference factors may vary due to different sensors and service life, please refer to the actual test results.
- 2) This table is not complete for all cross gases, other gas please contact with us.

Order Informations

	Part Number	Range	Resolution
Carbon Monoxide Gas Module 4Pin Cable	PS1-CO-1000-MOD Module 4 PIN cable	0-1000ppm	0.1 ppm

Linearity

Temperature environment: 26°C ; Humidity environment: 55%; Air chamber space: 0.03m³; Ventilation flow of air distribution system: 4000scm

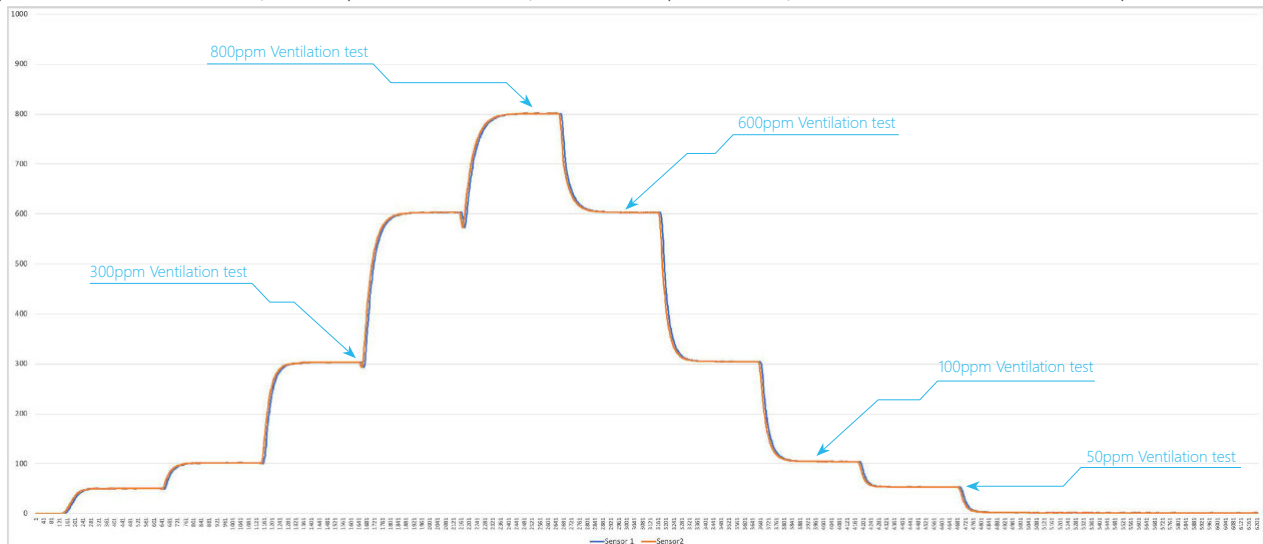

Test result: 0 ~ 1000ppm linear error $\pm 3\%$;

Zero Drift Testing (More than 12 hours)

Temperature environment: 26°C ; Humidity environment: 55%; Air chamber space: 0.03m³; Ventilation flow of air distribution system: 4000sccm

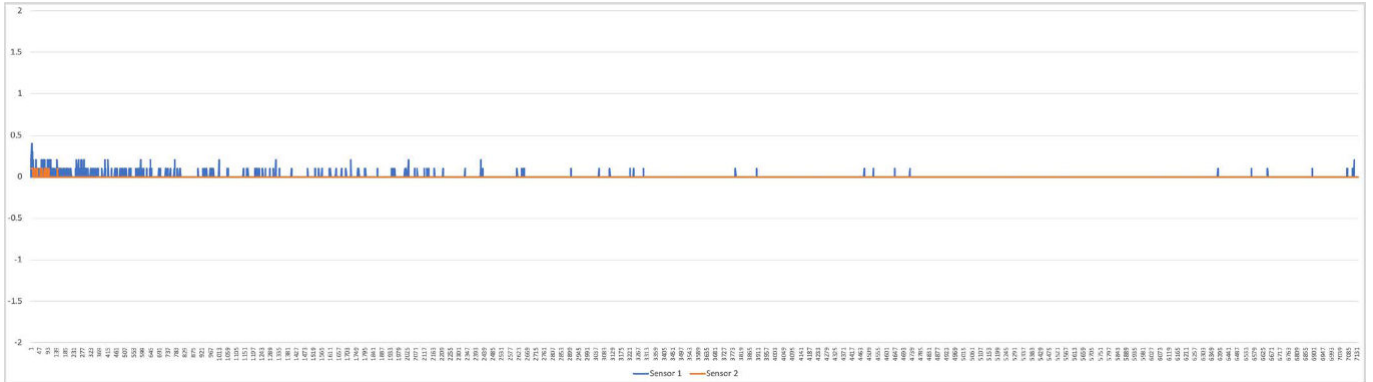

The test results show that the 12-hour relative clean air test has a zero drift range of <0.5ppm(0-2ppm is the normal zero fluctuation range);

300ppm Sensitivity Drift Testing

Temperature environment: 26°C ; Humidity environment: 55%; Air chamber space: 0.03m³; Ventilation flow of air distribution system: 4000sccm



Test result: 2 hours ventilation, range drift <5ppm;

Repeatability

Temperature environment: 26°C ; Humidity environment: 40%; Air chamber space: 0.03m³; Ventilation flow of air distribution system: 5000sccm

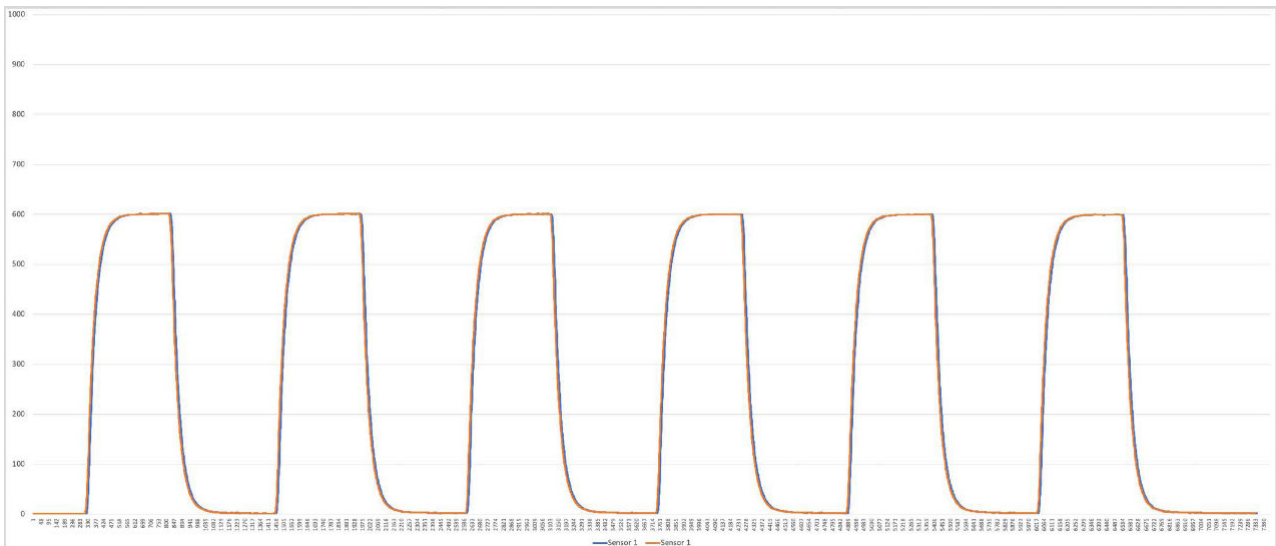

The test results show that the repeatability error range is <1ppm (1000ppm ± 1% of full scale is the normal range);

-40 °C -60 °C Temperature Characteristic Test (Wider Temperature Adaptation Range)

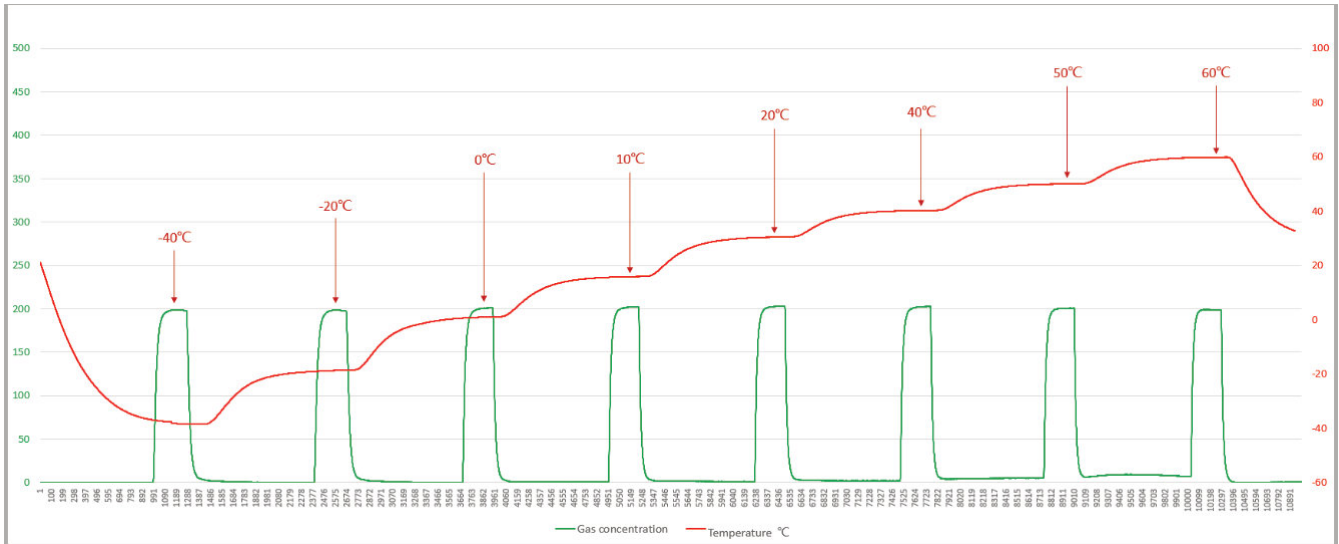

Structure Diagram (unit in mm)

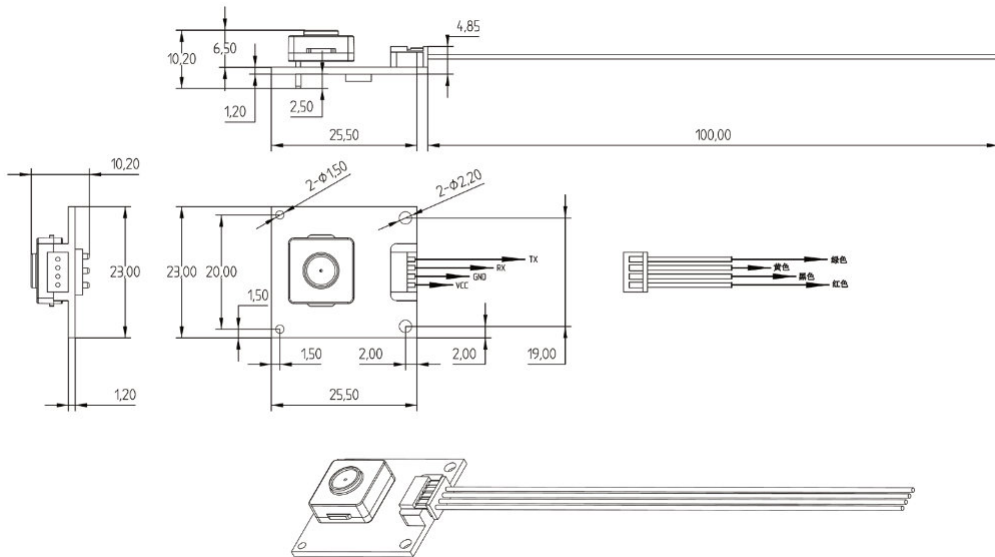

4Pin cable size diagram

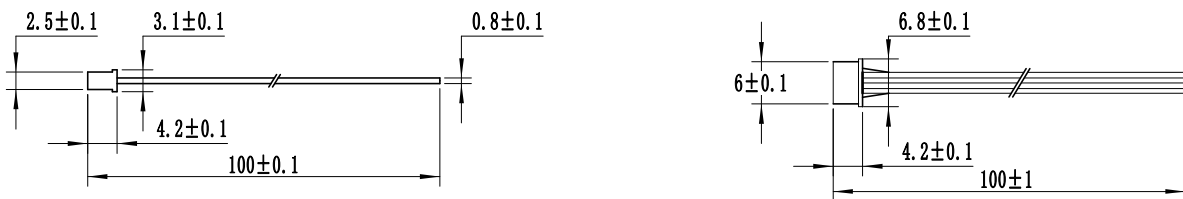

Specification

Principle	Solid Polymer Electrochemical Sensing Technology
Detection of gas	Carbon Monoxide
Detection Range	0-1000ppm; Display resolution: 0.1ppm
Lowest Detection Limit	5 ppm
Full-scale accuracy error	±5% F.S
Settling time	Stored in clean air for the first time power on <120 seconds
	Storage in non-clean air for the first power-on <240 seconds (except in the presence of high concentrations of polluted gas)
Response time	<3 seconds (T50: <40 seconds; T90: <80 seconds; T100: <180 seconds)
Zero return time	<120 seconds (Pass 99.999% high purity nitrogen)
Calibration Gas	1000ppm measurement range: 500ppm carbon monoxide gas calibration;
	Note: The smaller the range, the higher the detection accuracy, the user is not recommended to use over-range.
Sensor expected life time	Relatively clean air, temperature 0-25 ° C, humidity 30-70% for more than 3 years (often exposed to corrosive gas, high temperature environment and <20% low humidity environment, sensor life will be reduced)
Relative temperature error	± 0.2°C
Relative humidity error	± 2%
Output	The standard output is: 3.3V UART digital signal (see below for communication protocol);
	Interface definition: VCC- Red, GND- Black, RX- Yellow, TX- Green;
	Baud rate: 9600 Data bits: 8 bits Stop bits: 1 bit
Get data command	The communication is divided into active uploading and Q & A. The default is Q & A mode after power-on. You can use instructions to switch between the two modes.
	Return to Q & A mode after power off or switch power mode
	See next page for details
Working Voltage	3.3-5.5V DC
Working Current	< 5mA
Power Consumption	25mW @ 5V DC
Repeatability	Full range 100ppm ± 1% is the normal range
Working temperature	-20 - 55 °C
Optimal working temperature	20 - 35 °C
Working humidity	(15-95) %RH. (Non-condensing)
Optimum working humidity	40 - 70% RH.
Working pressure	Atm ± 10%
Board size	23 X 25.5 X 4.85 mm (with sensor)
Module size	23 X 25.5 X 10.2 mm
Weight	3.1g
Signal cable	The standard length is shown in the figure, and can be customized if there are special requirements.

User Guide

Thank you for choosing SGX Sensortech module. Before using it, please read this document in detail in order to use our products correctly and effectively.

Storage

The solid polymer sensor can be stored for more than 1 year at a humidity of 20-95% and a temperature of -5-25°C. Ensure that the storage environment is free from high concentrations of contaminated gases as far as possible. Sensors with a storage time of more than half a year, and the first power-on polarization time of more than 12 hours can fully activate the electrolyte and restore the best detection state.

1. The best storage environment of PS1-CO-1000-MOD is: temperature -5°C - 30°C, Relative humidity 25% - 95% (non-condensing);
2. The storage environment should keep the air clean, no pollution gas, no high concentration organic gas, no dust, no smoke;
3. Avoid storage with alcohol (ethanol), perfume, sodium silicate, and polyurethane liquids and solids.

Packing and shipping

1. Avoid prolonged direct sunlight during transportation, prevent rainwater penetration;
2. Transport packaging should be protected by Shock-proof bubble film or non-odor environmentally friendly sponge;
3. During long-term long-distance transportation, the temperature in the sensor package should be kept within 40°C as much as possible, and the maximum temperature should not exceed 55°C (do not store or use at this temperature for a long time);
4. During the transportation of the finished product, seal the air inlet of the sensor as much as possible to prevent the contaminated gas from entering the sensor, which will cause the value too high or the stabilization time too long when user use the product for the first time.

Steps for usage

1. Wiring

- Perform the corresponding wiring according to the identification of the output signal port of the structure diagram. Please refer to the 4Pin signal line label in the "Structure Diagram" above. For the power supply, see the voltage and current ranges marked in the indicators.

Note: incorrect wiring will cause the module to malfunction or damage the module.

2. Stable time

- The CO detection module needs a short stabilization time after power-on. The module is designed with plug-and-play function, and usually the stabilization time is within 2 minutes. However, if the concentration of the contaminated gas is high during storage, transportation or on-site environment, the stabilization time will increase. If the on-site ambient air is highly fluid, there will be fluctuations in the data. Please pay close attention to the on-site environment status. When the environmental condition is stable and there is no strong convection and air exchange, such as opening windows, opening doors, fans, air conditioners, fresh air systems, etc., as soon as the output signal is constant, and detection can begin.

(Note: Since it is a ppb-level high-precision module, the first power-on stabilization time varies under different storage and measurement environments.)

- When the detection module is stable, CO gas is usually present in normal air. Please refer to the CO data released by the nearest local environmental monitoring station for reference.

3. Diffusion use

- The module is used with a diffuse detection ambient gas, that is, the airflow naturally diffuses into the sensor. When the environment has a flow rate, it is necessary to ensure that the flow rate is within 500ml and that the flow rate is stable. The change of flow will cause the signal to fluctuate. When the flow is large, it will bring the change of pressure, which will cause the sensor signal value to change. The flow velocity will generate pressure, and the change in pressure will cause the output signal to change. The signal will increase when the pressure increase, and the sensor signal will change suddenly when the pressure change suddenly. Avoid negative pressure environment, which will cause physical irreparable damage to the sensor.

4. Temperature and humidity effects

- The detection module has been corrected for temperature compensation through an intelligent algorithm, which is suitable for the detection environment of 0-40°C. The sensor can work in the environment of -40°C - 55°C. There will be detection values in the temperature range outside the temperature compensation. The deviation is large. If you have special requirements, please contact the original factory for customization.
- The sensor is not affected by normal humidity changes, but rapid humidity changes will cause instantaneous peak changes, mainly due to condensation on the sensor surface caused by humidity changes, which will prevent outside air from entering the sensor, but the sensor will go stable in short time. The frequent and rapid changes in temperature or humidity will affect the chemical materials and cause the sensor life to be unexpectedly reduced. Due to the principle and characteristics of electrochemical sensors, changes in the environment have different levels of influence on the chemical electrolyte inside the sensor. The SGX Sensortech CO sensor module analyzes the changes of the sensor current data in detail through different environmental temperature and humidity impact tests, and combines the temperature and humidity sensor data to perform algorithmic compensation. During the use of the sensor, pay attention to the sudden changes in temperature and humidity will cause the sensor data to fluctuate abnormally. The CO sensor has good adaptability to the environment. Generally, it can fully adapt to the new environment and stabilize in 5-10 minutes. Detection.
- The sensor module must not be used and stored for a long time in a high-temperature and low-humidity environment with a humidity below 10% and a temperature above 55°C. Failure to do so may result in reduced sensor life, or failure, or invalid test data.

User Guide

Precautions

1. The main function of the gas sensor is to detect the gas composition and content. Please do not let any part of the sensor contact the liquid;
2. Different gas sensors have different measurement concentration ranges (ranges). Do not measure high-concentration gases for a long time during use;
3. The white or yellow sheet on the sensor is a waterproof and breathable film, please be careful not to scratch or pull it off;
4. Do not block or contaminate the surface of the sensor. Sometimes the blockage of the hole is the cause of reduced sensitivity and slow response time;
5. Please do not exchange the sensors of different gas modules. Doing so will cause measurement errors, because all the parameters of each sensor and each circuit board are matched and calibrated, and there will be deviations after the exchange;
6. Once the ES1 sensor is unplugged and re-inserted into the circuit board, please check that the three electrodes of the sensor correspond to the socket on the circuit board correctly to avoid irreversible damage to the sensor after reverse insertion;
7. Avoid excessive impact or vibration, and the case is damaged, please ensure that the structure is used without damage. If the case is damaged, please ensure that the structure is used without damage. If the case is broken and the internal structure is exposed, the output will no longer be reliable;
8. Pins must not be broken or bent. Doing so may damage the internal structure of the sensor;
9. It is slow to return to the initial state after long-term use in a high-concentration gas environment. The recovery speed is proportional to the overrange multiple;
10. 10ppm low range sensor should avoid high concentration and strong viscous gas for a long time contact with the sensor;
11. Please do not disassemble the sensor at will, it will damage the sensor;
12. Measurement range and accuracy. Select a gas sensor that matches the range and accuracy according to the actual application requirements and the gas concentration range. Otherwise, the gas may not be distinguished, accurate data may not be judged, and the sensor may be damaged;
13. When conducting on-site detection of CO gas, avoid the interference of other high-concentration gases on the site with CO, which will cause the error rate of the test results to increase.
14. Due to the principle and characteristics of the electrochemical sensor, in order to ensure the long life and the best working state of the sensor, the sensor should be kept in a continuous power state as much as possible;
15. When the CO module encounters high-concentration gases during use, such as CO gas, ethanol gas, and volatile organic gas. After the impact, the recovery time is slower. Placement in a clean air environment can shorten the recovery time.

DISCLAIMER:

SGX Europe Sp. z o.o. reserves the right to change design features and specifications without prior notification. We do not accept any legal responsibility for customer applications of our sensors. SGX Europe Sp. z o.o. accepts no liability for any consequential losses, injury or damage resulting from the use of this document, the information contained within or from any omissions or errors herein. This document does not constitute an offer for sale and the data contained is for guidance only and may not be taken as warranty. Any use of the given data must be assessed and determined by the user thereof to be in accordance with federal, state and local laws and regulations. All specifications outlined are subject to change without notice.

SGX Europe Sp. z o.o. sensors are designed to operate in a wide range of harsh environments and conditions. However, it is important that exposure to high concentrations of solvent vapours is to be avoided, both during storage, fitting into instruments and operation. When using sensors on printed circuit boards (PCBs), degreasing agents should be used prior to the sensor being fitted. SGX Europe Sp. z o.o. makes every effort to ensure the reliability of its products. Where life safety is a performance requirement of the product, we recommend that all sensors and instruments using these sensors are checked for response to gas before use.

Copyright© 2012-2022 SGX Sensortech All rights reserved.

Trademarks and registered trademarks are the property of their respective owners.

No part of this publication may be reproduced, distributed, or transmitted in any form or by any means, including photocopying, recording, or other electronic or mechanical methods, without the prior written permission of the publisher, except in the case of brief quotations embodied in critical reviews and certain other non-commercial uses permitted by copyright law.

For permission requests or technical support please contact or write to the publisher, addressed "Attention: Permissions Coordinator."

Communication Protocol

General settings

The sensor module uses serial communication. The communication configuration parameters are as follows:

Baud rate	9600
Data bits	8 bits
Stop bit	1 bit
Parity bit	None

Note: The communication is divided into active uploading and Q & A mode. The default mode is Q & A mode after power-on. You can use commands to switch between the two modes. After power-off or switching power consumption mode, the mode is restored.

Transmission mode switching instruction

Command 1 Instruction one switches to active upload. The command line format is as follows:

0	1	2	3	4	5	6	7	8
Start bit	Retain	Switch command	Automatic upload	Retain	Retain	Retain	Retain	Proof test value
0 x FF	0 x 01	0 x 78	0 x 40	0 x 00	0 x 00	0 x 00	0 x 00	0 x 47

Note: This format is fixed

Command 2 Switch to passive upload. The command line format is as follows:

0	1	2	3	4	5	6	7	8
Start bit	Retain	Switch command	Answer	Retain	Retain	Retain	Retain	Proof test value
0 x FF	0 x 01	0 x 78	0 x 41	0 x 00	0 x 00	0 x 00	0 x 00	0 x 46

Note: This format is fixed

Get module information instruction

Command 3 Gets sensor type, maximum range, unit, unit decimal places command: 0xD1
Returned value:

0	1	2	3	4	5	6	7	8
Sensor type	Maximum range high	Maximum range low	Unit	Retain	Retain	Retain	Number of decimal places (bit[4]~bit[7]) Data sign (bit[0]~bit[3])	Parity bit
0 x 23	0 x 00	0 x CB	0 x 02	0 x 00	0 x 00	0 x 00	0 x 00	0 x 35

Note:

Max range = (Max range high << 8) | Max range low

Units: 0x02 (ppm and mg / m³) 0x04 (ppb and ug / m³)

Signs: 0 (positive number) 1 (negative number)

Decimal places: how many decimal places to read the concentration value, the maximum number of decimal places is 3

Communication Protocol

Command 4 Get the sensor type, maximum range, unit, and decimal places command: 0xD7

0	1	2	3	4	5	6	7	8
Command header 1	Command header 2	Sensor type	Maximum range high	Maximum range low	Unit	Number of decimal places (bit[4]~bit[7]) Data sign (bit[0]~bit[3])	Retain	Parity bit
0 x FF	0 x D7	0 x 23	0 x 00	0 x C8	0 x 02	0 x 01	0 x 00	0 x 3B

Explanation:

Checksum: 1 ~ 7 bits of data are added to generate an 8-bit data.invert every bit and add 1 to the end

Decimal places bit [4] ~ bit [7]:

(bit[7]<<3) | (bit[6]<<2) | (bit[5]<<1) | bit[4] = decimal places

Data sign (bit[0]~bit[3]):

(bit[3]<<3) | (bit[2]<<2) | (bit[1]<<1) | bit[0] = 0 Negative inhibition

(bit[3]<<3) | (bit[2]<<2) | (bit[1]<<1) | bit[0] = 1 Positive inhibition

Unit :

0x02: unit is mg/m³ and ppm

0x04: unit is um/m³ and ppb

0x08: unit is 10g/m³ and %

Command 5 The format for actively reading the gas concentration value is as follows :

0	1	2	3	4	5	6	7	8
Start bit	Retain	Command	Retain	Retain	Retain	Retain	Retain	Parity bit
0 x FF	01	0 x 86	0 x 00	0 x 00	0 x 00	0 x 00	0 x 00	0 x 79

Returned value:

0	1	2	3	4	5	6	7	8
Start bit	Command	High gas concentration (ug/m ³)	Low gas concentration (ug/m ³)	Full range high	Full range low	High gas concentraton (ppb)	Low gas concentraton (ppb)	Parity bit
0 x FF	0 x 86	0 x 00	0 x 2A	0 x 00	0 x 00	0 x 00	0 x 20	0 x 30

Description:

Checksum: 1 ~ 7-bit data is added to generate an 8-bit data.invert every bit and add 1 to the end

Gas concentration value = high gas concentration *256 + low gas concentration ;

(The high and low concentrations need to be converted from hexadecimal to decimal and then brought into this formula to calculate

Communication Protocol

Command 6 Gas concentration value and temperature and humidity combined reading instruction

0	1	2	3	4	5	6	7	8
Start bit	Retain	Command	Retain	Retain	Retain	Retain	Retain	Parity bit
0 x FF	0 x 00	0 x 87	0 x 00	0 x 00	0 x 00	0 x 00	0 x 00	0 x 79

Returned value:

0	1	2	3	4	5	6	7	8	9	10	11	12
Start bit	Command	High gas concentration (ug/m ³)	Low gas concentration (ug/m ³)	Full range high	Full range low	High gas concentration (ppb)	Low gas concentration (ppb)	Temperature high	Temperature low	Humidity high	Humidity low	Parity bit
0 x FF	0 x 87	0 x 00	0 x 2A	0 x 03	0 x E8	0 x 00	0 x 20	0 x 09	0 x C4	0 x 13	0 x 88	0 x DC

Description:

Checksum: 1 ~ 11 bits of data are added to generate an 8-bit data, each bit is inverted, and 1 is added at the end.

Gas concentration value = high gas concentration * 256 + low gas concentration;

(The high and low concentrations need to be converted from hex) adecimal to decimal and then brought into this formula to calculate

Temperature is signed data with two decimal places (°C-Celsius) Pseudo code calculation formula:

$$T = (\text{float})((\text{int})((0x0A \ll 8) | 0x09)) / 100$$

Humidity is data without signs and two decimal places. The unit is (rh%). Pseudo code calculation formula:

$$Rh = (\text{float})((\text{uint})((0x0A \ll 8) | 0x09)) / 100$$

Command 7 Get the current temperature and humidity

Returned value:

0	1	2	3
Temperature high 8 bit	Temperature low 8 bit	Humidity high 8 bit	Humidity low 8 bit
0 x 0A	0 x 09	0 x 11	0 x F4

Description:

Temperature is signed data with two decimal places and the unit is (°C-Celsius)

Pseudo code calculation formula:

$$T = (\text{float})((\text{int})((0x0A \ll 8) | 0x09)) / 100$$

Humidity is data without sign and two decimal places, the unit is (rh%)

Pseudo code calculation formula:

$$Rh = (\text{float})((\text{uint})((0x0A \ll 8) | 0x09)) / 100$$

Communication Protocol

Command 8 Get the current temperature and humidity with calibration
Returned value:

0	1	2	3	4
Temperature high 8 bit	Temperature low 8 bit	Humidity high 8 bit	Humidity low 8 bit	Checksum
0 x 0A	0 x 09	0 x 11	0 x F4	0 x E8

Description:

Checksum: 0 ~ 3 digits of data are added to generate an 8-bit data. Each bit is inverted, plus 1 at the end
Temperature is data with a sign and two decimal places. The unit is (°C-Celsius)

Pseudo code calculation formula:

$$T = (\text{float})((\text{int})((0x0A \ll 8) | 0x09)) / 100$$

Humidity is data with no sign and two decimal places in units (rh%).

Pseudo code calculation formula:

$$Rh = (\text{float})((\text{uint})((0x0A \ll 8) | 0x09)) / 100$$

Command 9 Get the current version number
Returned value:

0	1	2	3	4	5
0 x 19	0 x 05	0 x 27	0 x 00	0 x 10	0 x 01

Data in active upload mode

The upload data format is as follows:

0	1	2	3	4	5	6	7	8
Start bit	Command	High gas concentration (ug/m ³)	Low gas concentration (ug/m ³)	Full range high	Full range low	High gas concentration (ppb)	Low gas concentration (ppb)	Parity bit
0 x FF	0 x 86	0 x 00	0 x 2A	0 x 00	0 x 00	0 x 00	0 x 20	0 x 30

Note:

Checksum: Add 1 to 11 digits of data to generate 8 digits of data, invert each bit, add 1 at the end

Gas concentration value = high gas concentration * 256 + low gas concentration

(The high and low concentrations need to be converted from hexadecimal to decimal and then brought into this formula to calculate)

Low power switching

Enter sleep mode

0	1	2	3	4	5
0 x AF	0 x 53	0 x 6C	0 x 65	0 x 65	0 x 70

Returned value :

0	1
0 x 4F	0 x 4B

Communication Protocol

Exit sleep mode

0	1	2	3	4
0x AE	0x 45	0x 78	0x 69	0x 74

Returned value :

0	1
0x 4F	0x 4B

Note: after exiting sleep mode, it takes 5 seconds to recover, no data within 5 seconds

Enter sleep mode

0	1	2	3	4	5	6
0x A1	0x 53	0x 6C	0x 65	0x 65	0x 70	0x 32

Returned value :

0	1	2	3	4	5	6	7	8
0x FF	0x A1	0x 00	0x 00	0x 00	0x 00	0x 00	0x 00	5F

Exit sleep mode

0	1	2	3	4	5
0x A2	0x 45	0x 78	0x 69	0x 74	0x 32

Returned value :

0	1	2	3	4	5	6	7	8
0x FF	0x A2	0x 00	0x 00	0x 00	0x 00	0x 00	0x 00	5E

Communication Protocol

Turn off the running lights

0	1	2	3	4	5	6	7	8
Start bit	Retain	Command	Retain	Retain	Retain	Retain	Retain	Checksum
0 x FF	0 x 01	0 x 88	0 x 00	0 x 00	0 x 00	0 x 00	0 x 00	0 x 77

Return :

0	1
0 x 4F	0 x 4B

Turn on the running lights

0	1	2	3	4	5	6	7	8
Start bit	Retain	Command	Retain	Retain	Retain	Retain	Retain	Checksum
0 x FF	0 x 01	0 x 89	0 x 00	0 x 00	0 x 00	0 x 00	0 x 00	0 x 76

Return :

0	1
0 x 4F	0 x 4B

Query the running light status

0	1	2	3	4	5	6	7	8
Start bit	Retain	Command	Retain	Retain	Retain	Retain	Retain	Checksum
0 x FF	0 x 01	0 x 8A	0 x 00	0 x 00	0 x 00	0 x 00	0 x 00	0 x 75

Return :

0	1	2	3	4	5	6	7	8
Start bit	Command	State value	Retain	Retain	Retain	Retain	Retain	Checksum
0 x FF	0 x 8A	0 x 01	0 x 00	0 x 00	0 x 00	0 x 00	0 x 00	0 x 75

Note: Status value 1 (light on), 0 (light off)