

# 2J6047M

## CELLULAR/LTE and 2.4/5.0 GHz ISM Magnetic Mount

### Key Features

#### Cable 1: CELLULAR / LTE

- 698-960 MHz
- 1710-2170 MHz
- 2500-2700 MHz

#### Cable 2: 2.4/5.0 GHz ISM

- 2410-2490 MHz
- 4920-5925 MHz

Magnetic Mount

Ground Plane Independent

Customizable Cable and Connector

Dimensions: 80 x 76 x 13 mm



## 2. Antenna and electrical specifications

Cable 1

Parameters	CELLULAR / LTE Antenna		
<b>Standards</b>	2G,3G and 4G		
<b>Band (MHz)</b>	700/850/900	1700/1800/1900/2100	2600
<b>Frequency (MHz)</b>	698-960	1710-2170	2500-2700
<b>Return Loss (dB)</b>	~-11.3	~-6.6	~-15.2
<b>VSWR</b>	~1.8:1	~2.8:1	~1.5:1
<b>Efficiency (%)</b>	~37.8	~27.3	~51.3
<b>Peak Gain (dBi)</b>	~1.5	~3.2	~6.0
<b>Average Gain (dB)</b>	~-4.3	~-5.7	~-2.9
<b>Impedance (Ohm)</b>	50		
<b>Polarisation</b>	Linear		
<b>Radiation Pattern</b>	Omni-Directional		
<b>Max. Input Power (W)</b>	25		
<b>Connector Type</b>	SMA-Male Standard (Other Connectors Available)		
<b>Cable Length</b>	300 cm Standard (Any Cable Length Available)		
<b>Cable Type</b>	D302 Standard (Other Cables Available)		

Cable 2

Parameters	2.4/5.0 GHz ISM Antenna	
<b>Standards</b>	WiFi, BT, ZigBee, ISM	
<b>Band (MHz)</b>	2.4 GHz	5.0 GHz
<b>Frequency (MHz)</b>	2410-2490	4920-5925
<b>Return Loss (dB)</b>	~-12.7	~-20.4
<b>VSWR</b>	~1.7:1	~1.3:1
<b>Efficiency (%)</b>	~42.1	~39.2
<b>Peak Gain (dBi)</b>	~3.0	~4.8
<b>Average Gain (dB)</b>	~-3.8	~-4.1
<b>Impedance (Ohm)</b>	50	
<b>Polarisation</b>	Linear	
<b>Radiation Pattern</b>	Omni-Directional	
<b>Max. Input Power (W)</b>	25	
<b>Connector Type</b>	RP-SMA-Male Standard (Other Connectors Available)	
<b>Cable Length</b>	300 cm Standard (Any Cable Length Available)	
<b>Cable Type</b>	D302 Standard (Other Cables Available)	

**Antenna Measurement Conditions:**

Mounted on 30 x 30 x 0.25 cm Metal Plate

200 cm of Cable D302

Measured in Certified CTIA 3D Anechoic Chamber

### 3. Mechanical and environmental specifications

Specifications	2J6047M
<b>Mounting Type</b>	Magnetic Mount
<b>Dimensions (mm)</b>	80 x 76 x 13
<b>Radome Type</b>	ASA
<b>Radome Color</b>	Black or White
<b>Operating Temperature (C)</b>	-40 to +85
<b>Storage Temperature (C)</b>	-40 to +85
<b>Substance Compliance</b>	RoHS

## 4. Antenna parameters

**Table 1: CELLULAR/LTE**

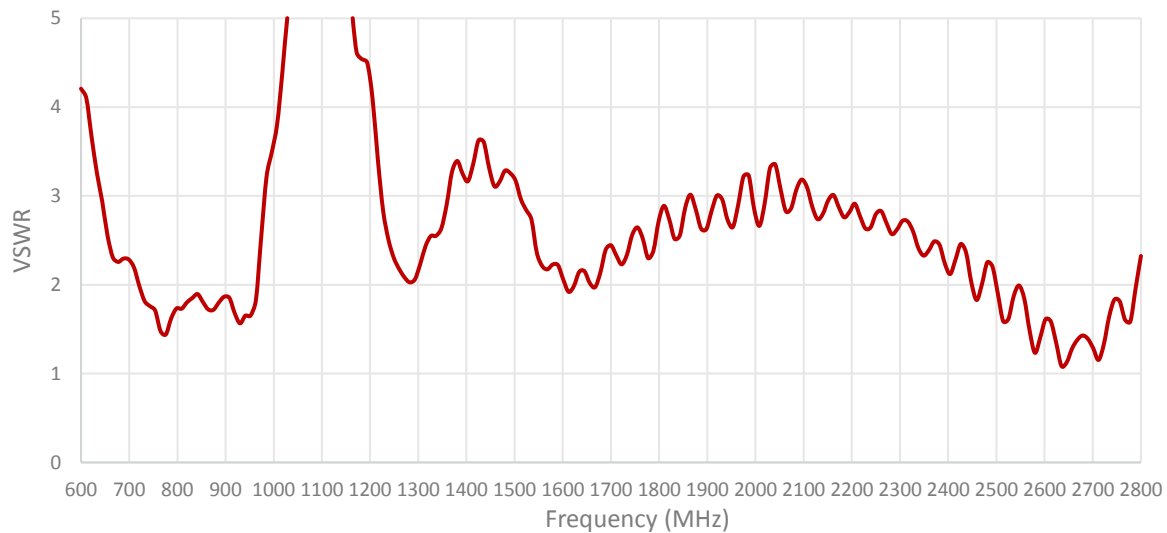
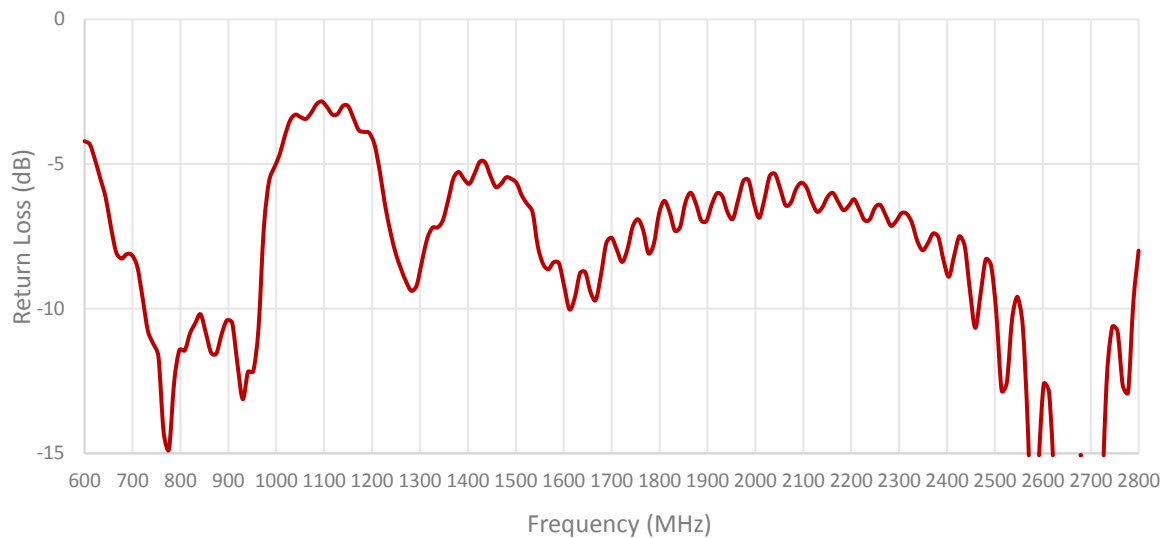

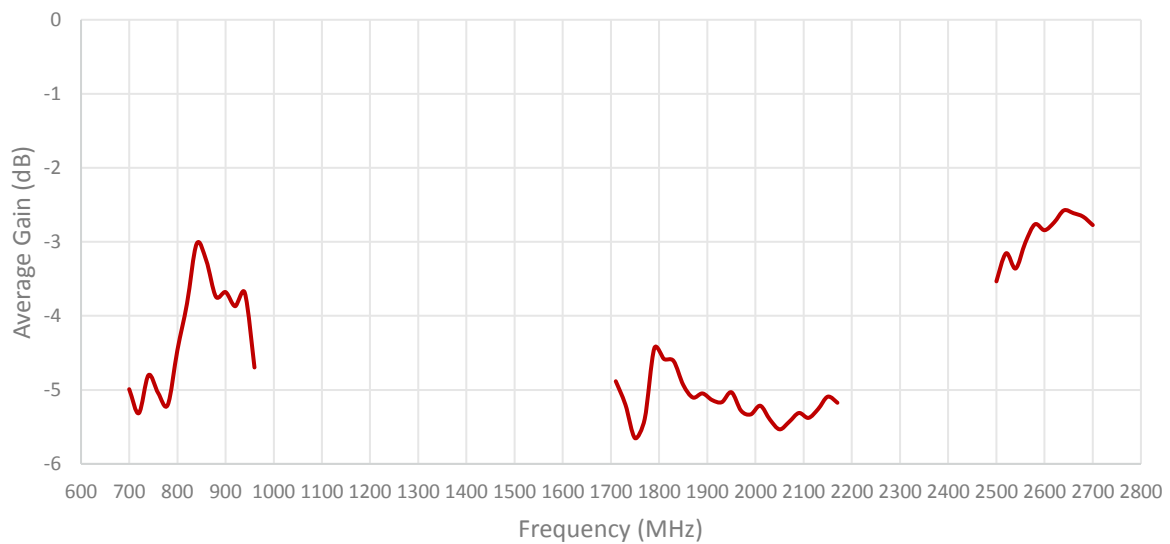
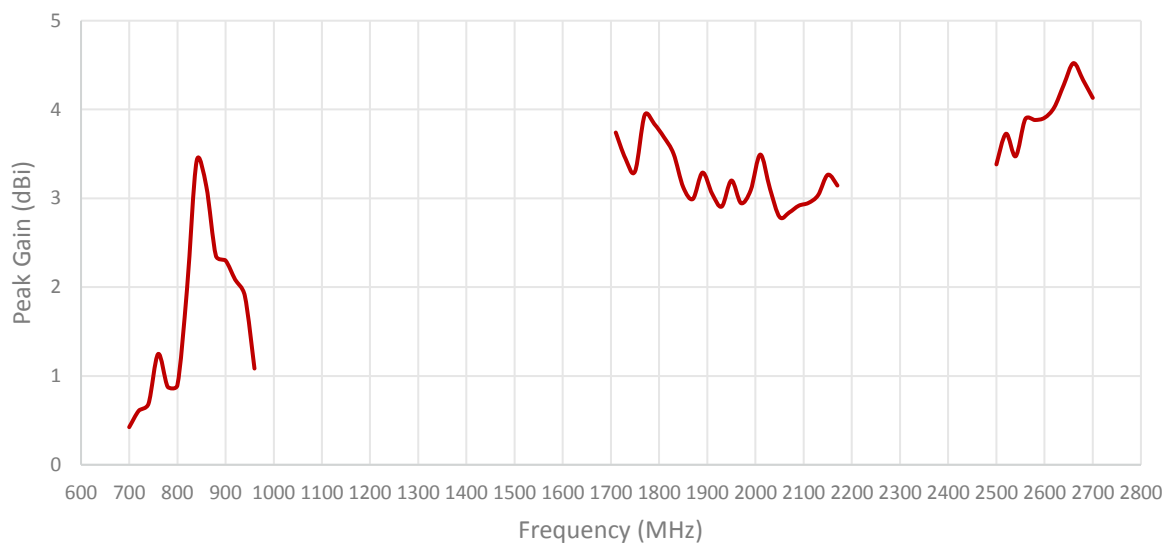
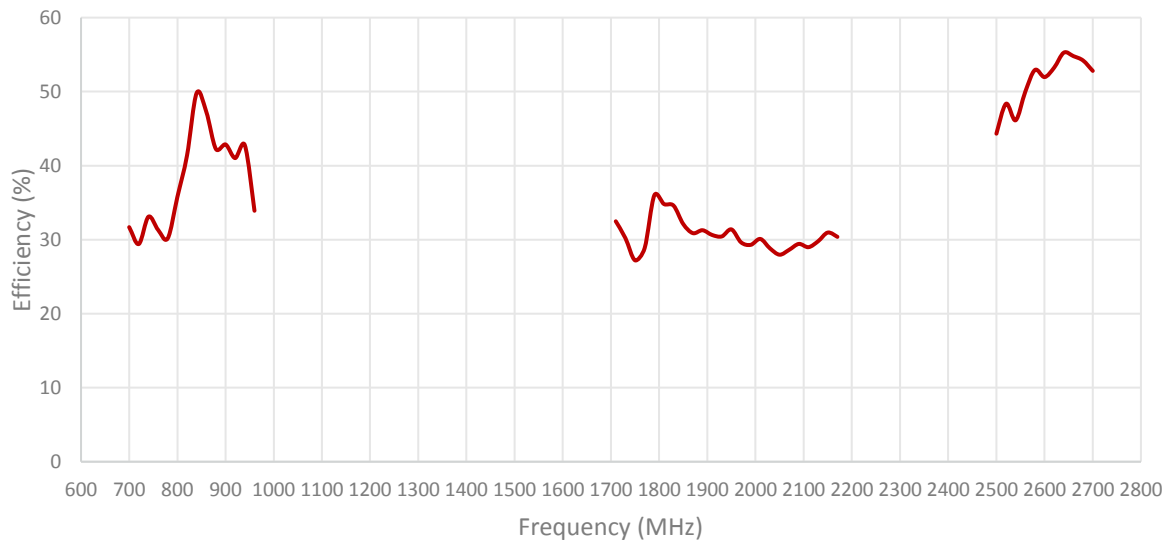

**Cable 2: 2.4/5.0 GHz ISM**

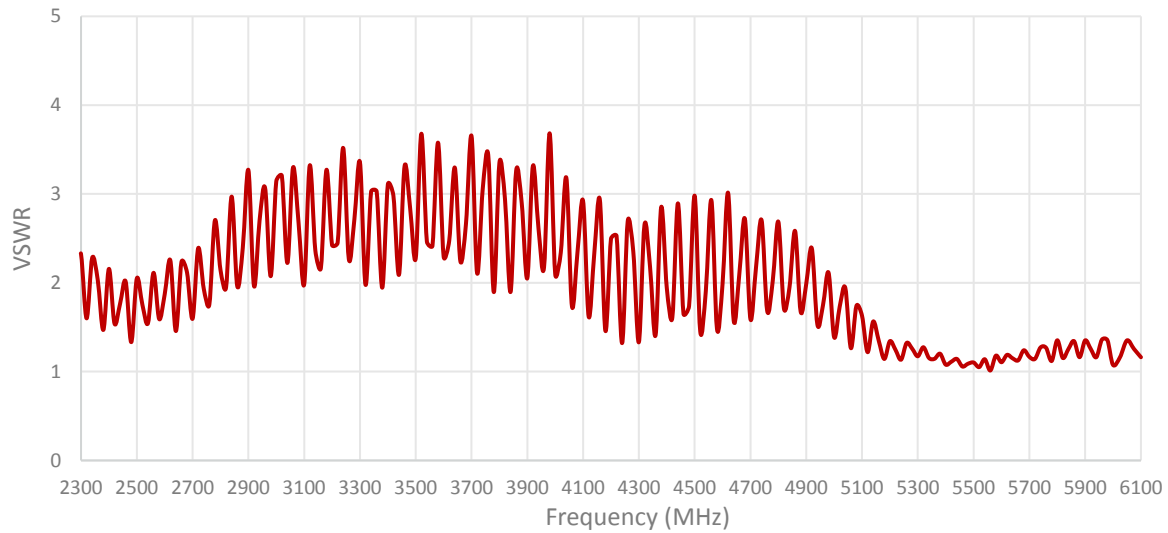
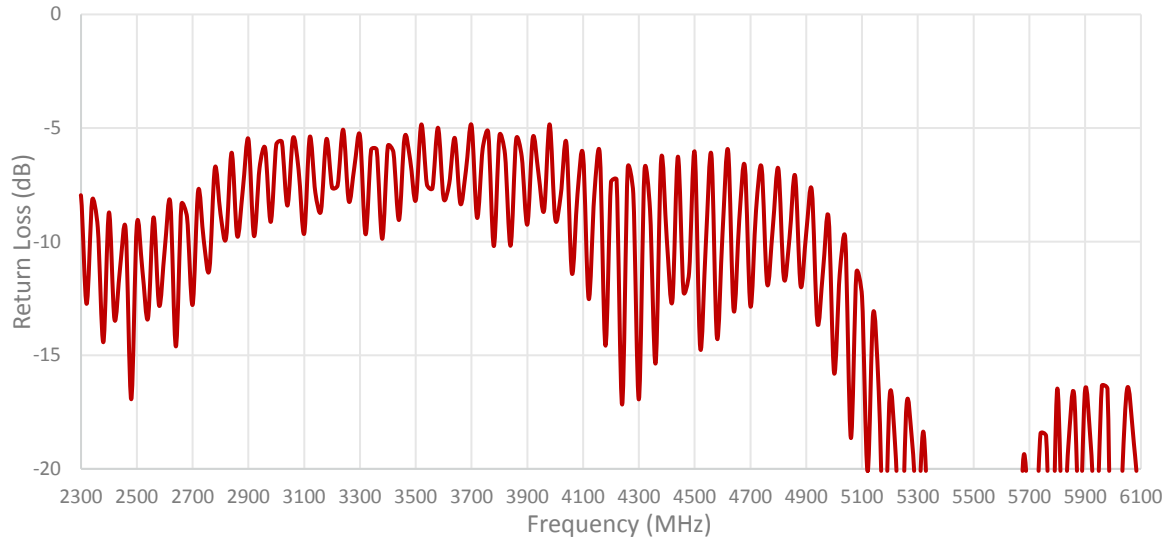

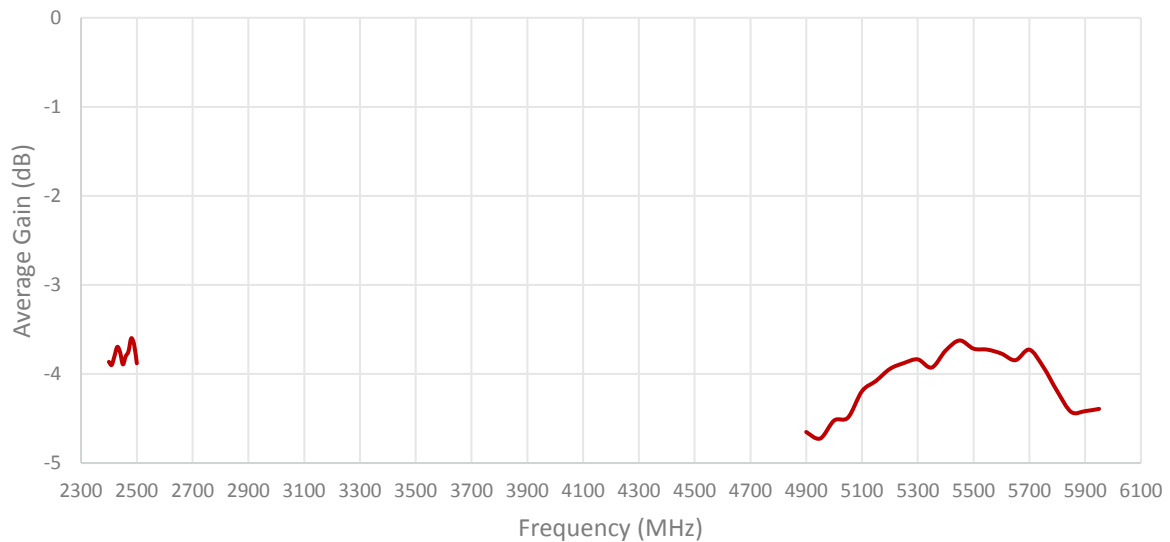
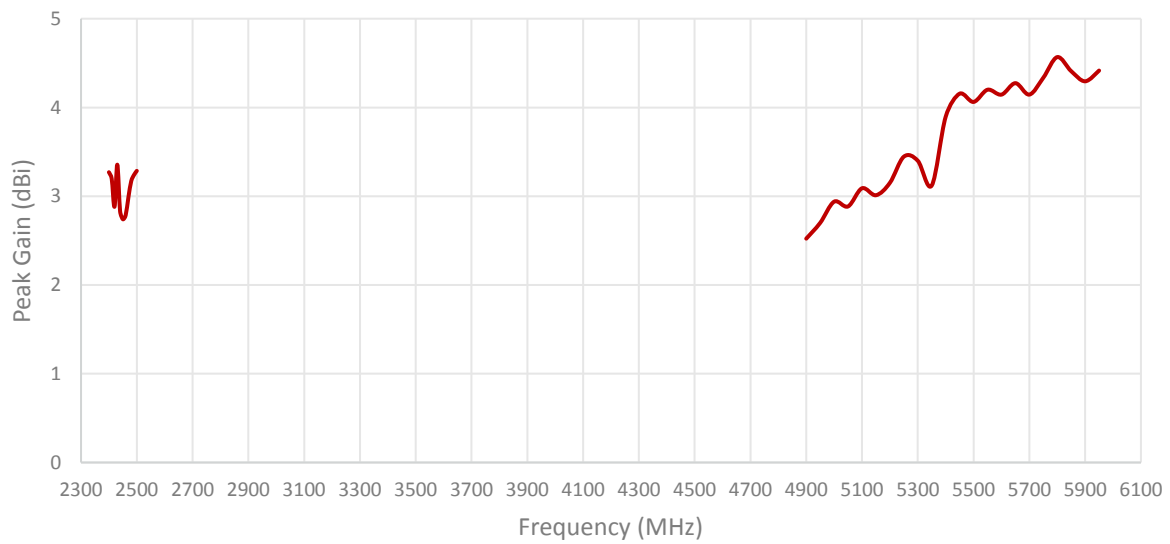
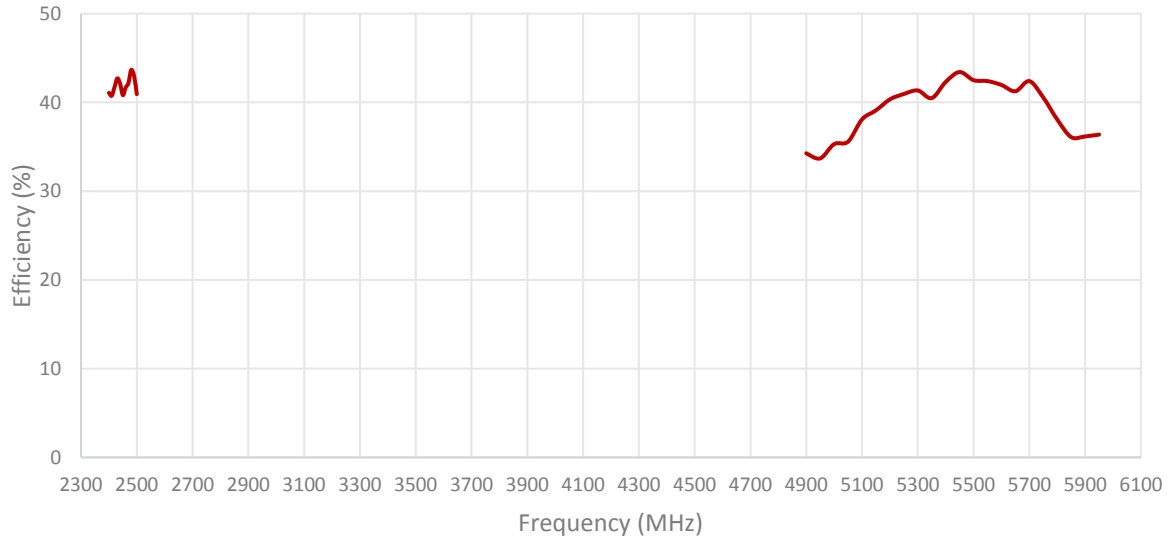

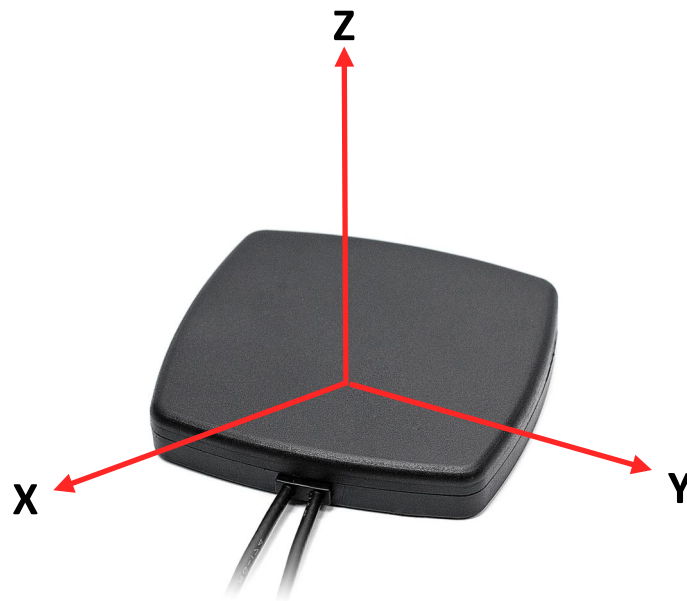

Radiation pattern reference

Table 1: CELLULAR/LTE

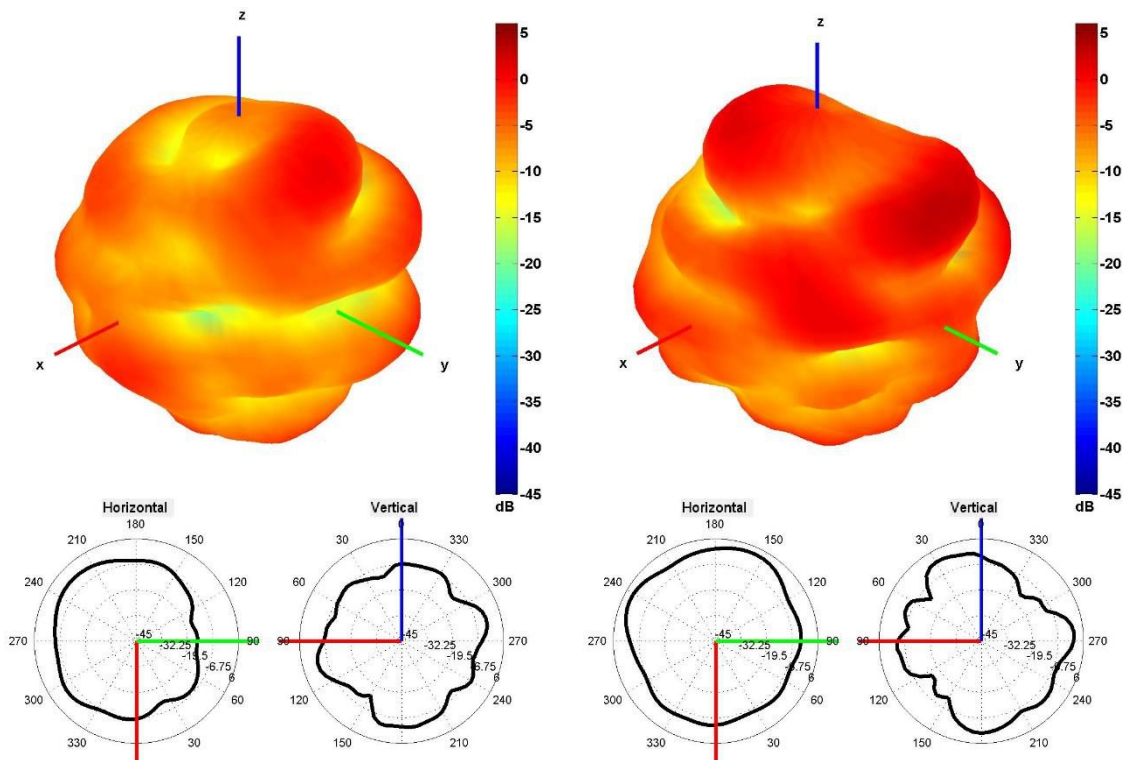

750 and 850 MHz Radiation pattern



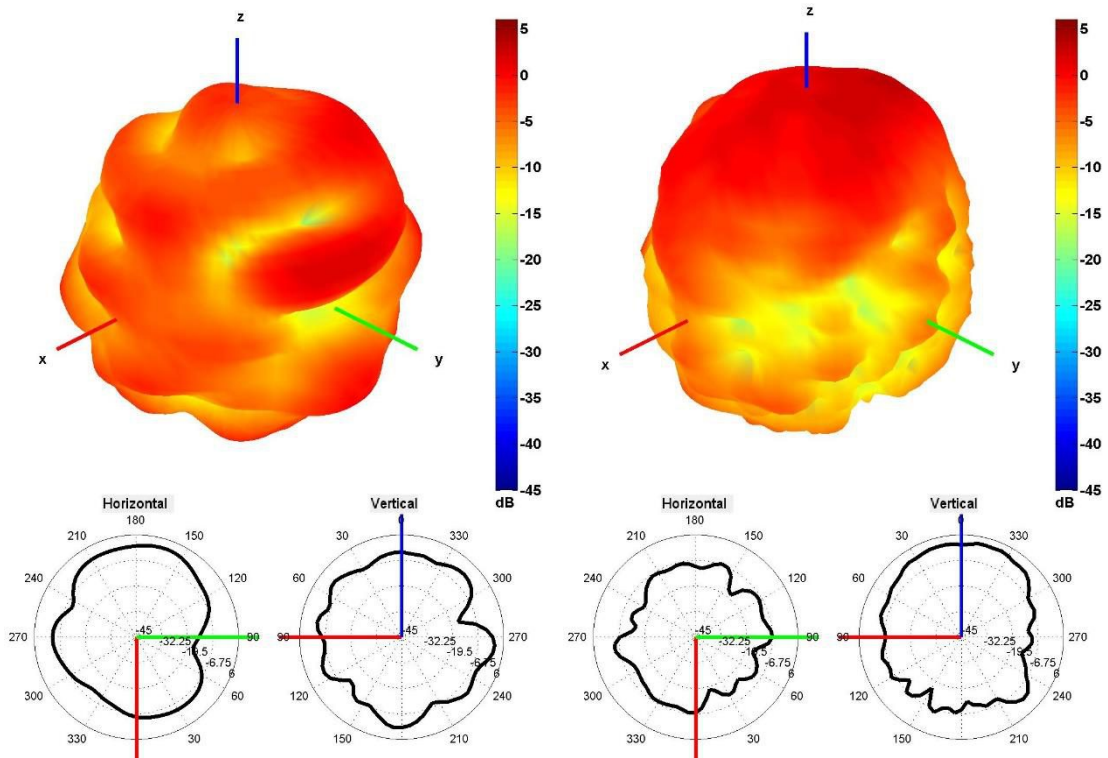

940 and 1750 MHz Radiation pattern

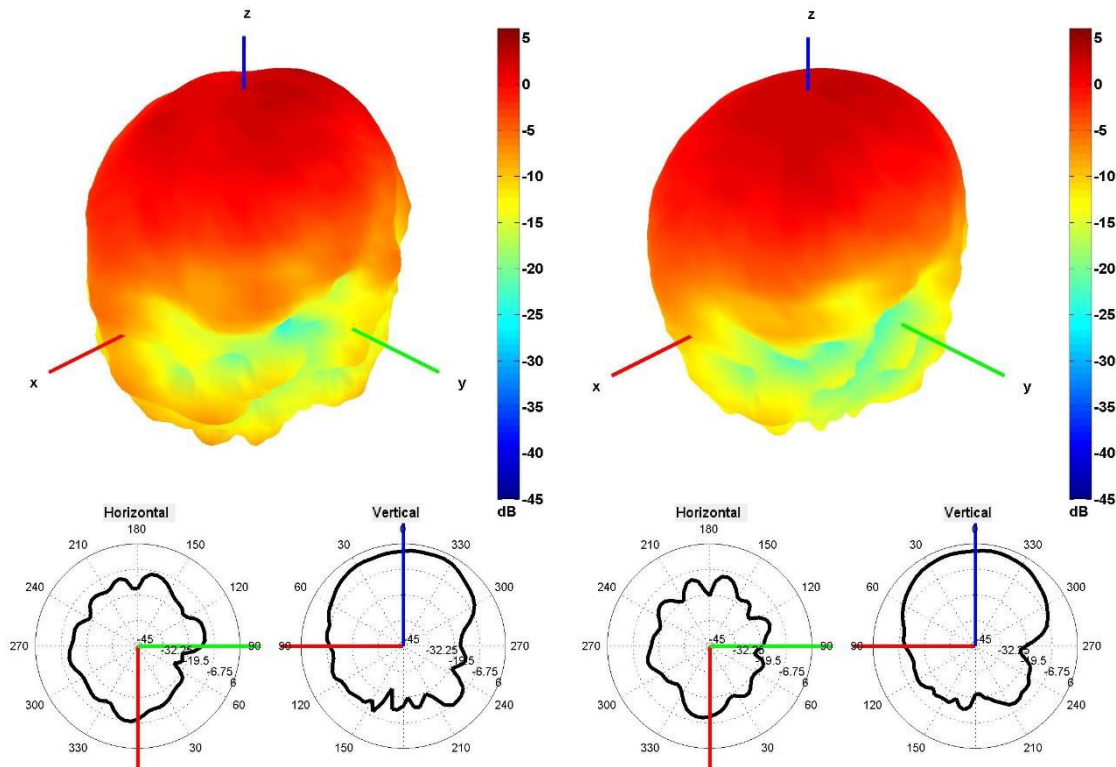

1850 and 1950 MHz Radiation pattern

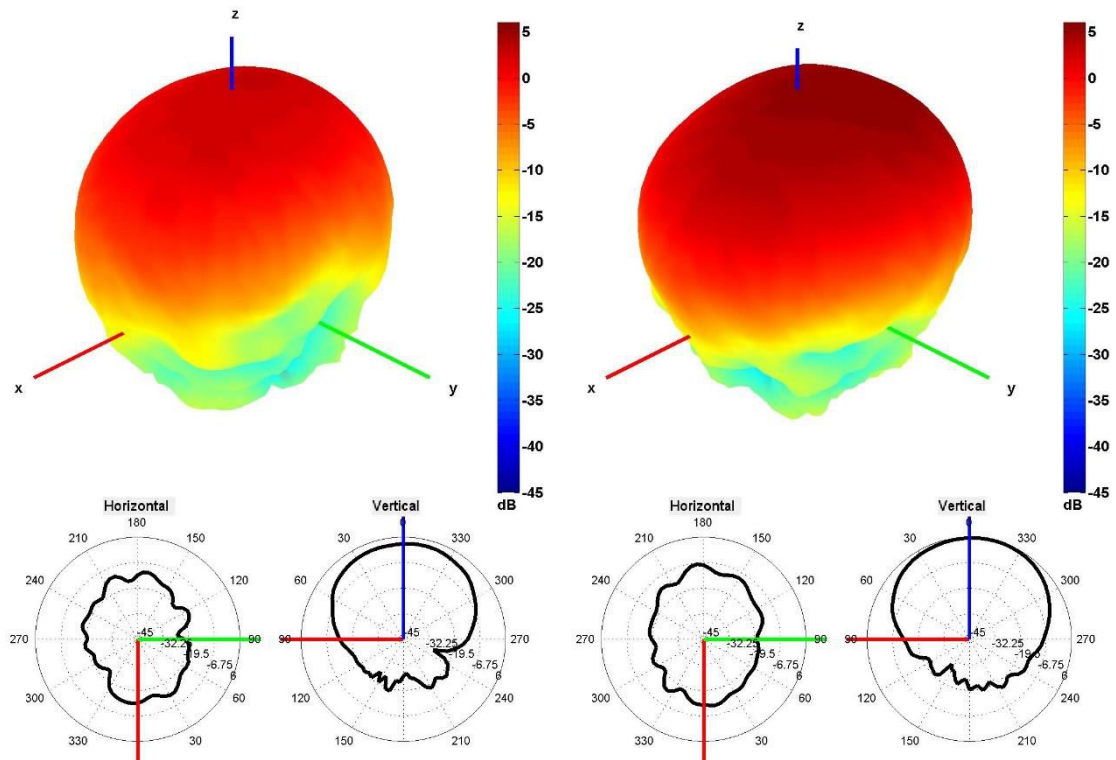

2100 and 2600 MHz Radiation pattern

Cable 2: 2.4/5.0 GHz ISM

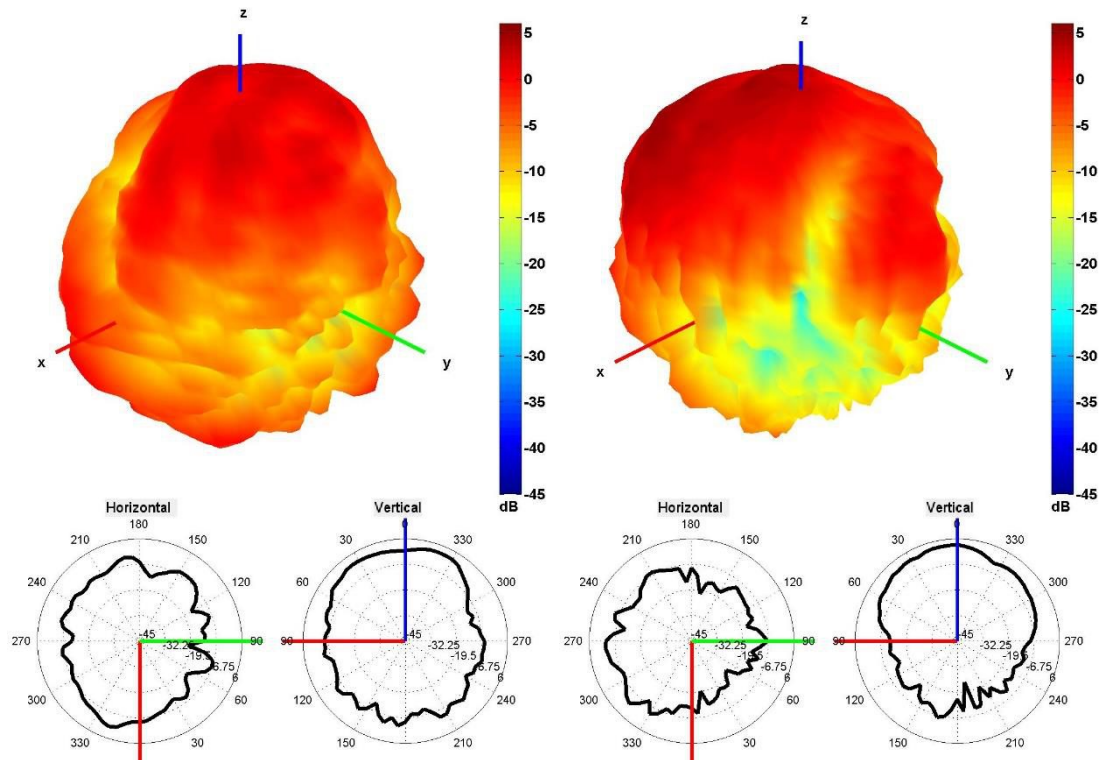

2450 and 5500 MHz Radiation pattern

#### 4. Antenna drawings

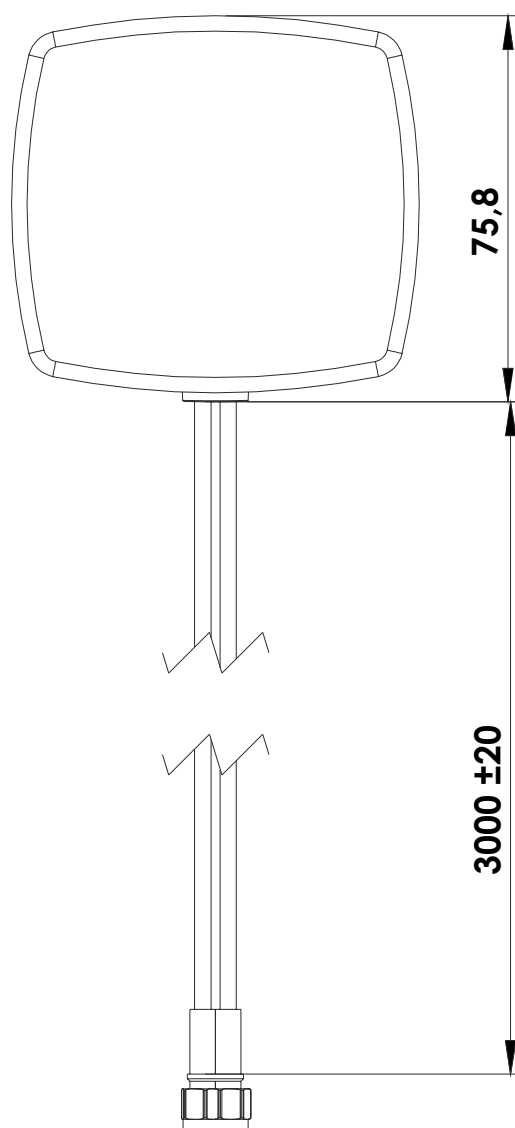
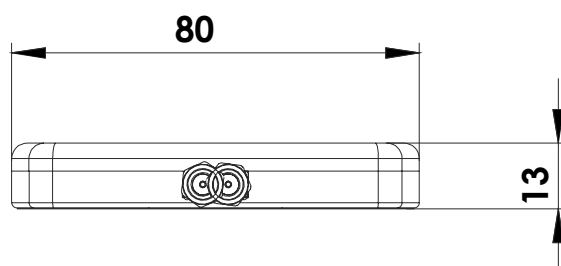

5. Antenna Images

