

Base strip - MCV 1,5/ 5-GF-3,5 - 1843253

Please be informed that the data shown in this PDF Document is generated from our Online Catalog. Please find the complete data in the user's documentation. Our General Terms of Use for Downloads are valid (<http://phoenixcontact.com/download>)

Header, nominal current: 8 A, rated voltage (III/2): 160 V, number of positions: 5, pitch: 3.5 mm, color: green, contact surface: Tin, mounting: Wave soldering



The figure shows a 10-position version of the product

Why buy this product

- ✓ Well-known mounting principle allows worldwide use
- ✓ Screwable flange for superior mechanical stability
- ✓ Vertical connection enables multi-row arrangement on the PCB
- ✓ Maximum flexibility when it comes to device design – one header for connectors with different connection technologies

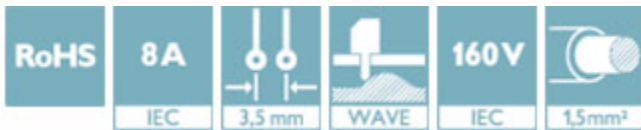

Key Commercial Data

Packing unit	1 STK
GTIN	
GTIN	4017918112448
Weight per Piece (excluding packing)	2.490 g
Custom tariff number	85366930
Country of origin	Germany

Technical data

Dimensions

Length [l]	7.25 mm
Pitch	3.5 mm
Dimension a	14 mm
Width [w]	27.8 mm
Constructional height	9.2 mm

Base strip - MCV 1,5/ 5-GF-3,5 - 1843253

Technical data

Dimensions

Height [h]	12.6 mm
Length of the solder pin	3.4 mm
Pin dimensions	0,8 x 0,8 mm
Hole diameter	1.2 mm

General

Range of articles	MCV 1,5/..-GF
Insulating material group	IIIa
Rated surge voltage (III/3)	2.5 kV
Rated surge voltage (III/2)	2.5 kV
Rated surge voltage (II/2)	2.5 kV
Rated voltage (III/3)	160 V
Rated voltage (III/2)	160 V
Rated voltage (II/2)	250 V
Connection in acc. with standard	EN-VDE
Nominal current I_N	8 A
Maximum load current	8 A
Insulating material	PBT
Flammability rating according to UL 94	V0
Color	green
Number of positions	5

Standards and Regulations

Connection in acc. with standard	EN-VDE
	CSA
Flammability rating according to UL 94	V0

Environmental Product Compliance

China RoHS	Environmentally Friendly Use Period = 50
	For details about hazardous substances go to tab "Downloads", Category "Manufacturer's declaration"

Drawings

Base strip - MCV 1,5/ 5-GF-3,5 - 1843253

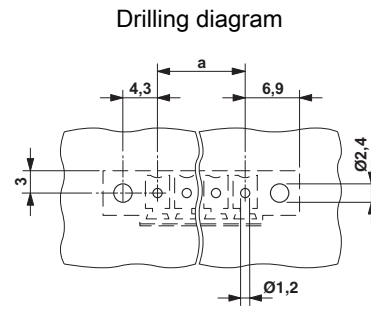
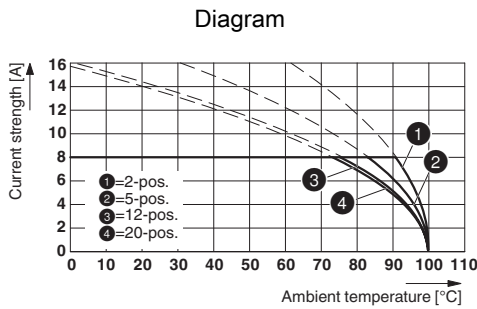

Type: MC 1,5/...-STF-3,5 with MCV 1,5/...-GF-3,5

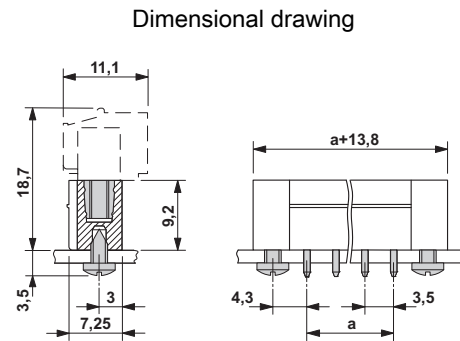
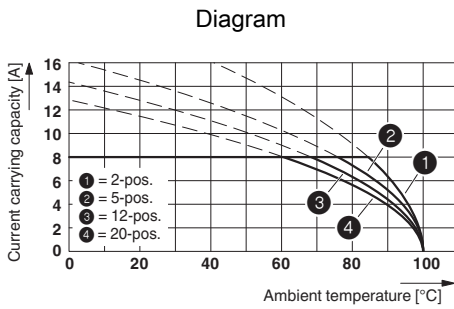

Classifications

eCl@ss

eCl@ss 4.0	272607xx
eCl@ss 4.1	27260701
eCl@ss 5.0	27260701
eCl@ss 5.1	27260701
eCl@ss 6.0	27260704
eCl@ss 7.0	27440402
eCl@ss 8.0	27440402
eCl@ss 9.0	27440402

ETIM

ETIM 3.0	EC001121
ETIM 4.0	EC002637
ETIM 5.0	EC002637
ETIM 6.0	EC002637

UNSPSC

UNSPSC 6.01	30211810
-------------	----------

Base strip - MCV 1,5/ 5-GF-3,5 - 1843253

Classifications

UNSPSC

UNSPSC 7.0901	39121409
UNSPSC 11	39121409
UNSPSC 12.01	39121409
UNSPSC 13.2	39121409

Approvals

Approvals

Approvals

CSA / VDE Gutachten mit Fertigungsüberwachung / IECEE CB Scheme / CCA / cULus Recognized / EAC

Ex Approvals

Approval details

CSA		http://www.csagroup.org/services-industries/product-listing/	13631
		B	D
Nominal current IN		8 A	8 A
Nominal voltage UN		300 V	300 V

VDE Gutachten mit Fertigungsüberwachung		http://www.vde.com/en/Institute/OnlineService/VDE-approved-products/Pages/Online-Search.aspx	40011723
Nominal current IN		8 A	
Nominal voltage UN		160 V	

IECEE CB Scheme		http://www.iecee.org/	DE1-58415-B1B2
Nominal current IN		8 A	
Nominal voltage UN		160 V	

Base strip - MCV 1,5/ 5-GF-3,5 - 1843253

Approvals

CCA		CCA/ DE1 34219
Nominal current IN	8 A	
Nominal voltage UN	160 V	

cULus Recognized		http://database.ul.com/cgi-bin/XYV/template/LISEXT/1FRAME/index.htm	E60425-20110128
	B	D	
Nominal current IN	8 A	8 A	
Nominal voltage UN	300 V	300 V	

EAC		B.01742
-----	--	---------

Accessories

Accessories

Coding element

Coding profile - CP-MSTB - 1734634

Coding profile, is inserted into the slot on the plug or inverted header, red insulating material



Labeled terminal marker

Marker card - SK 3,5/2,8:FORTL.ZAHLEN - 0804073



Marker card, Card, white, labeled, Horizontal: Consecutive numbers 1 - 10, 11 - 20, etc. up to 91 - 99, mounting type: adhesive, for terminal block width: 3.5 mm, lettering field size: 3.5 x 2.8 mm

Additional products

Base strip - MCV 1,5/ 5-GF-3,5 - 1843253

Accessories

Printed-circuit board connector - TFMC 1,5/ 5-STF-3,5 - 1772731

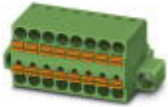

Plug component, nominal current: 8 A, rated voltage (III/2): 160 V, number of positions: 5, pitch: 3.5 mm, connection method: Push-in spring connection, color: green, contact surface: Tin

Printed-circuit board connector - MC 1,5/ 5-STF-3,5 - 1847084



Plug component, nominal current: 8 A, rated voltage (III/2): 160 V, nominal current (Ex): 8 A, nominal voltage (Ex): 160 V, number of positions: 5, pitch: 3.5 mm, connection method: Screw connection with tension sleeve, color: green, contact surface: Tin

Printed-circuit board connector - MCVW 1,5/ 5-STF-3,5 - 1863039



Plug component, nominal current: 8 A, rated voltage (III/2): 160 V, number of positions: 5, pitch: 3.5 mm, connection method: Screw connection with tension sleeve, color: green, contact surface: Tin

Printed-circuit board connector - MCVR 1,5/ 5-STF-3,5 - 1863330



Plug component, nominal current: 8 A, rated voltage (III/2): 160 V, number of positions: 5, pitch: 3.5 mm, connection method: Screw connection with tension sleeve, color: green, contact surface: Tin

Printed-circuit board connector - FK-MCP 1,5/ 5-STF-3,5 - 1940127

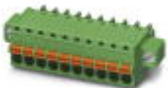

Plug component, nominal current: 8 A, rated voltage (III/2): 160 V, number of positions: 5, pitch: 3.5 mm, connection method: Push-in spring connection, color: green, contact surface: Tin

Base strip - MCV 1,5/ 5-GF-3,5 - 1843253

Accessories

Printed-circuit board connector - FMC 1,5/ 5-STF-3,5 - 1966127

Plug component, nominal current: 8 A, rated voltage (III/2): 160 V, number of positions: 5, pitch: 3.5 mm, connection method: Push-in spring connection, color: green, contact surface: Tin

