

Data Sheet | Item Number: 2601-1108

PCB terminal block; lever; 1.5 mm²; Pin spacing 3.5 mm; 8-pole; Push-in CAGE

CLAMP®; 1,50 mm²; gray

<https://www.wago.com/2601-1108>

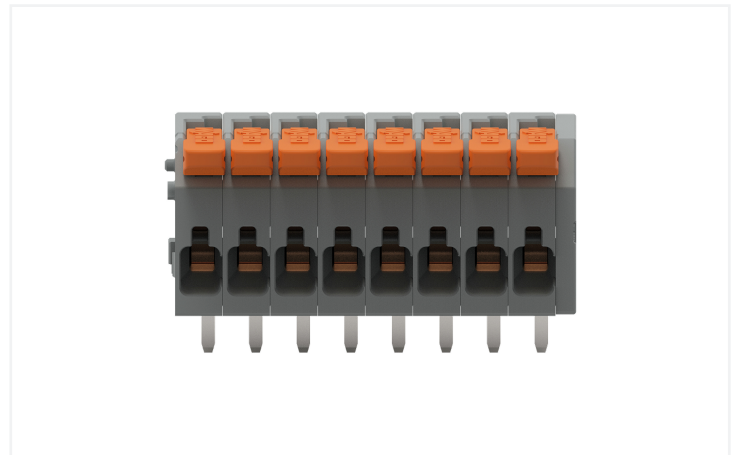

Color: ■ gray

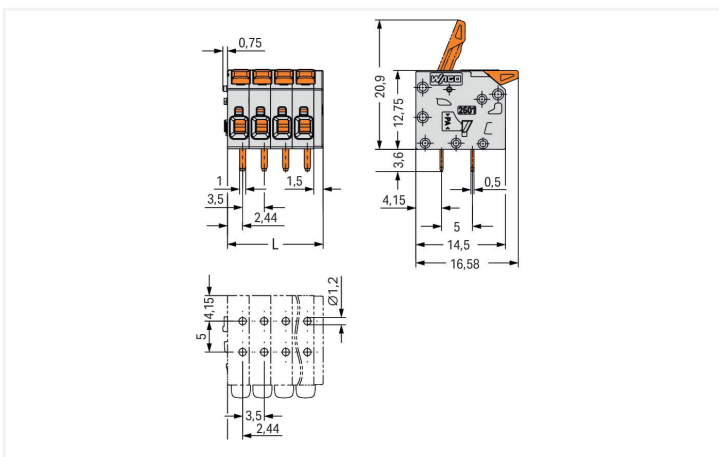
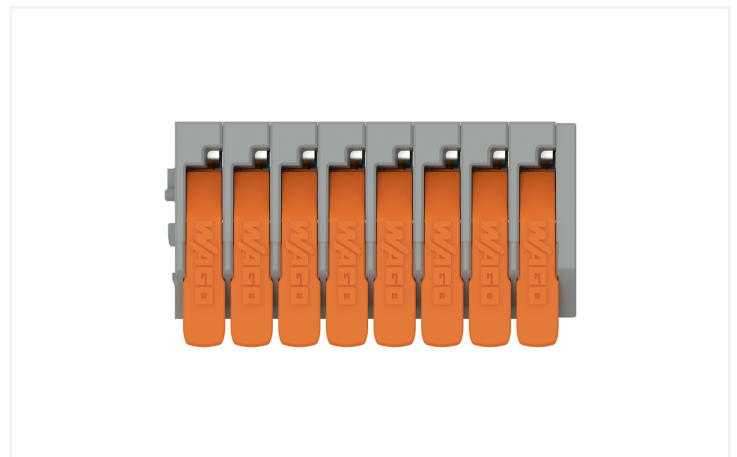

Dimensions in mm

$L = (\text{pole no.} - 1) \times \text{pin spacing} + 5 \text{ mm}$

- PCB terminal blocks with Push-in CAGE CLAMP® connection and levers
- Push-in termination of solid and ferruled conductors
- Intuitive and tool-free operation
- Several clamping units can be held open simultaneously, simplifying the connection of multi-core cables
- Testing can be performed both parallel and perpendicular to conductor entry

Notes

Variants:	Other pole numbers Direct marking Other colors Other versions (or variants) can be requested from WAGO Sales or configured at https://configurator.wago.com/ .
-----------	--

Electrical data

Ratings per	IEC/EN 60664-1			Approvals per	UL 1059		
Overtoltage category	III	III	II	Use group	B	C	D
Pollution degree	3	2	2	Rated voltage	300 V	-	300 V
Nominal voltage	160 V	160 V	320 V	Rated current	10 A	-	10 A
Rated surge voltage	2.5 kV	2.5 kV	2.5 kV				
Rated current	17.5 A	17.5 A	17.5 A				

Approvals per	CSA		
Use group	B	C	D
Rated voltage	300 V	-	300 V
Rated current	10 A	-	10 A

Connection data

Connection points	8	Connection 1	
Total number of potentials	8	Connection technology	Push-in CAGE CLAMP®
Number of connection types	1	Actuation type	Lever
Number of levels	1	Solid conductor	0.14 ... 1.5 mm ² / 26 ... 14 AWG
		Solid conductor; push-in termination	0.5 ... 1.5 mm ² / 26 ... 14 AWG
		Fine-stranded conductor	0.2 ... 1.5 mm ² / 26 ... 14 AWG
		Fine-stranded conductor; with insulated ferrule	0.25 ... 0.75 mm ²
		Fine-stranded conductor; with uninsulated ferrule	0.25 ... 1.5 mm ²
		Note (conductor cross-section)	For conductors (26 AWG) that are not rigid enough, the clamping unit must be opened using a lever.
		Strip length	8 ... 9 mm / 0.31 ... 0.35 inches
		Conductor connection direction to PCB	0°
		Pole number	8

Physical data

Pin spacing	3.5 mm / 0.138 inches
Width	29.5 mm / 1.161 inches
Height	16.35 mm / 0.644 inches
Height from the surface	12.75 mm / 0.502 inches
Depth	16.58 mm / 0.653 inches
Solder pin length	3.6 mm
Solder pin dimensions	1 x 0.5 mm
Drilled hole diameter with tolerance	1.2 (+0.1) mm

PCB contact

PCB contact	THT
Solder pin arrangement	over the entire terminal strip (in-line)
Number of solder pins per potential	2

Material data

Note (material data)	Information on material specifications can be found here
Color	gray
Material group	I
Insulation material	Polyamide (PA66)
Flammability class per UL94	V0
Clamping spring material	Chrome-nickel spring steel (CrNi)
Contact material	Electrolytic copper (E _{Cu})
Contact plating	Tin
Fire load	0.119 MJ
Actuator color	orange
Weight	6.2 g

Environmental requirements

Limit temperature range	-60 ... +105 °C
Processing temperature	-35 ... +60 °C
Continuous operating temperature	-60 ... +105 °C

Commercial data

ETIM 8.0	EC002643
PU (SPU)	60 pcs
Country of origin	PL
GTIN	4066966242119
Customs tariff number	85369010000

Environmental Product Compliance

RoHS Compliance Status	Compliant, No Exemption
------------------------	-------------------------

Approvals / Certificates

General approvals



Approval	Standard	Certificate Name
CB DEKRA Certification B.V.	IEC 60947-7-4	NL-86025
CSA CSA Group	C22.2	80120532
KEMA/KEUR DEKRA Certification B.V.	EN 60947-7-4	71-127124
UL Underwriters Laboratories Inc.	UL 1059	E45172

Downloads

Environmental Product Compliance

Compliance Search

Environmental Product
Compliance 2601-1108



Documentation

Additional Information

Technical Section

03.04.2019

pdf

1949.09 KB



CAD/CAE-Data

CAD data

2D/3D Models
2601-1108

