

USR-GM3P User Manual

File Version: V1.0.0.02



Contents

USR-GM3P User Manual	1
Features	3
1. Get Start	1
1.1. Application	1
1.1.1. Data transmission	1
1.1.2. Hardware Connection	2
1.2. Module Default Parameters	2
1.3. Basic Parameters	2
1.4. Dimensions	3
1.5. LED	4
2. Product Functions	5
2.1. APN	5
2.2. Work Mode	5
2.2.1. Network transparent transmission mode	5
2.2.2. HTTPD Client mode	6
2.2.3. SMS transparent transmission mode	7
2.2.4. UDC transparent transmission mode	8
2.3. Serial Port	9
2.3.1. Parameters range	9
2.3.2. Serial Package Methods	9
2.3.3. RS485	9
2.3.4. Baud Rate Synchronization	9
2.4. Features	10
2.4.1. Identity Packet Function	10
2.4.2. Heartbeat Packet Function	10
2.4.3. Sleep mode	10
2.4.4. Location Based Service	11
2.4.5. GPS	11
2.4.6. Upgrade firmware version	11
3. Parameter Setting	12
3.1. AT Command	12
3.1.1. Serial AT Command	12
3.1.2. Transparent AT Command	12
3.1.3. SMS AT Command	12
4. Contact Us	13
5. Disclaimer	13
6. Update History	13

Features

- Support GSM850/900, DCS1800/1900
- Support GSM/GPRS; Support 2G flow of 2G/3G/4G SIM card
- Support four way network connections simultaneously; Support TCP and UDP
- Every connection supports 4KB data Cache
- Support identity packet
- Support heartbeat packet
- Support configuring parameters via SMS
- Support four work modes: SMS transparent transmission mode, network transparent transmission mode, HTTPD Client mode and UDC transparent transmission mode
- Support sending CN/EN SMS via commands
- Support UDC protocol
- Support GPS function
- Support serial port flow control, RTS/CTS

1. Get Start

Product link:

<http://www.usriot.com/p/small-gprs-modems-low-power-gprs-modules-gps-positioning/>

USR-GM3P setup software, download address:

<http://www.usriot.com/usr-gm3-setup-software/>

Figure 1 Download Page

If you have any question, please submit it back to customer center: <http://h.usriot.com>

1.1. Application

1.1.1. Data transmission

Data transmission diagram as follow:

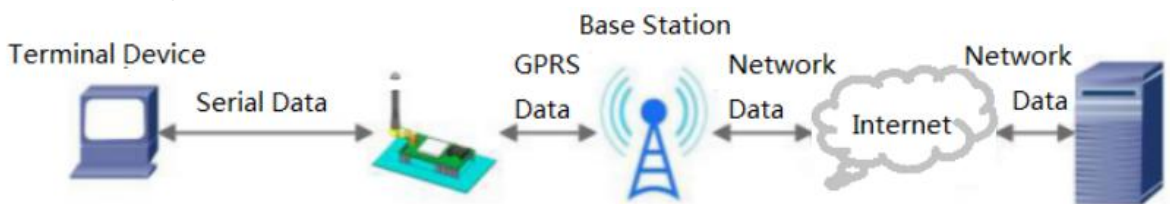

Figure 2 Data transmission

1.1.2. Hardware Connection

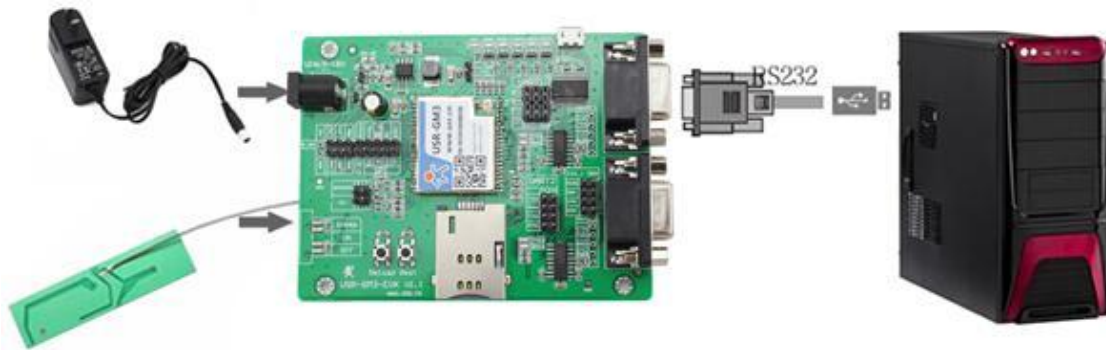

Figure 3 Hardware connection

1.2. Module Default Parameters

Work mode	Network transparent transmission mode
Server Address	test.usr.cn
Server Port	2317
Serial Parameters	115200, 8, 1, None
Heartbeat packet	Packet data:www.usr.cn

Figure 4 Default parameters

1.3. Basic Parameters

	Parameter	Index	
Wireless Parameters	Wireless Standards	GSM/GPRS	
	Standard frequency range	850/900/1800/1900MHz	
	Max. Transmitted Power	GSM900 class4 (2W)	
		DCS1800 class1 (1W)	
	GPRS Terminal Device Class	Class B	
	GPRS Multi-slot Class	GPRS Class 10	
	GPRS Coding Schemes	CS1 ~ CS4	
Antenna	I-PEX Interface		
Hardware Parameters	Data Interface	UART: 2400bps - 921600bps	
	Working Voltage	DC 3.4V~4.2V	
	Working Current	Average: 155mA-190mA; MAX: 850mA	
	Working Temp.	-25°C - 85°C	
	Storage Temp.	-40°C - 125°C	
	Dimension	27.9×24.0×3.0mm	
Software Parameters	Wireless network type	GSM/GPRS	
	Work Mode	Transparent, SMS, HTTPD and UDC mdoe	

	Setting Command	AT+ Command Structure
	Network protocol	TCP /UDP/ DNS/HTTP
	Max. TCP connection	4
	User Configuration Method	Setup Software and AT command
Software Functions	DNS	Support
	Transparent Mode	TCP Client or UDP Client
	HTTP	HTTPD Client Mode
	UDC	Support
	SMS Mode	Support
	Heartbeat Data packet	To Serial port side or Network side
	Baud rate synchronization	Support
	GPS	Support
	Identity packet	Support editable and ICCID identity packet

Figure 5 Basic parameters

1.4. Dimensions

Below is the dimension figure of USR-GM3P:

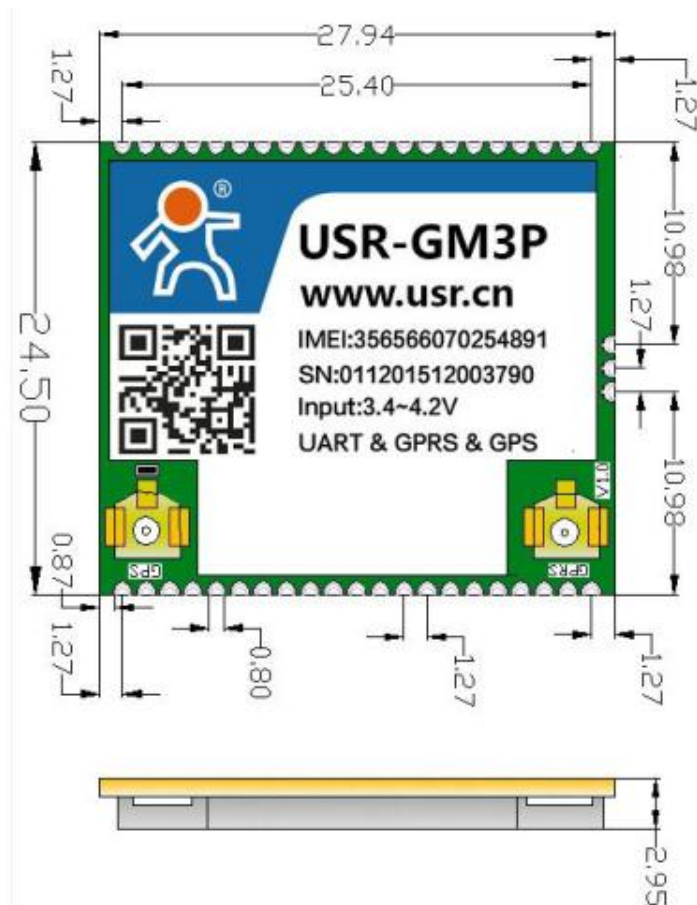
Figure 6 Dimension

1.5. LED

LED of USR-GM3P are DATA, WORK, GPRS, LINKA and LINKB.

LED NAME	LED Status	Module Status
DATA	BLINK	Have serial/network data transmission
	OFF	No serial/network data
WORK	BLINK	Working
	OFF	Not Working
GPRS	ON	GPRS network is connected
	OFF	GPRS network is disconnected
LINKA	ON	Socket A is connected
	OFF	Socket A is disconnected
LINKB	ON	Socket B is connected
	OFF	Socket B is disconnected

Figure 7 LED

2. Product Functions

This chapter introduces the functions of USR-GM3P, as the following diagram shown, you can get an overall knowledge of it.

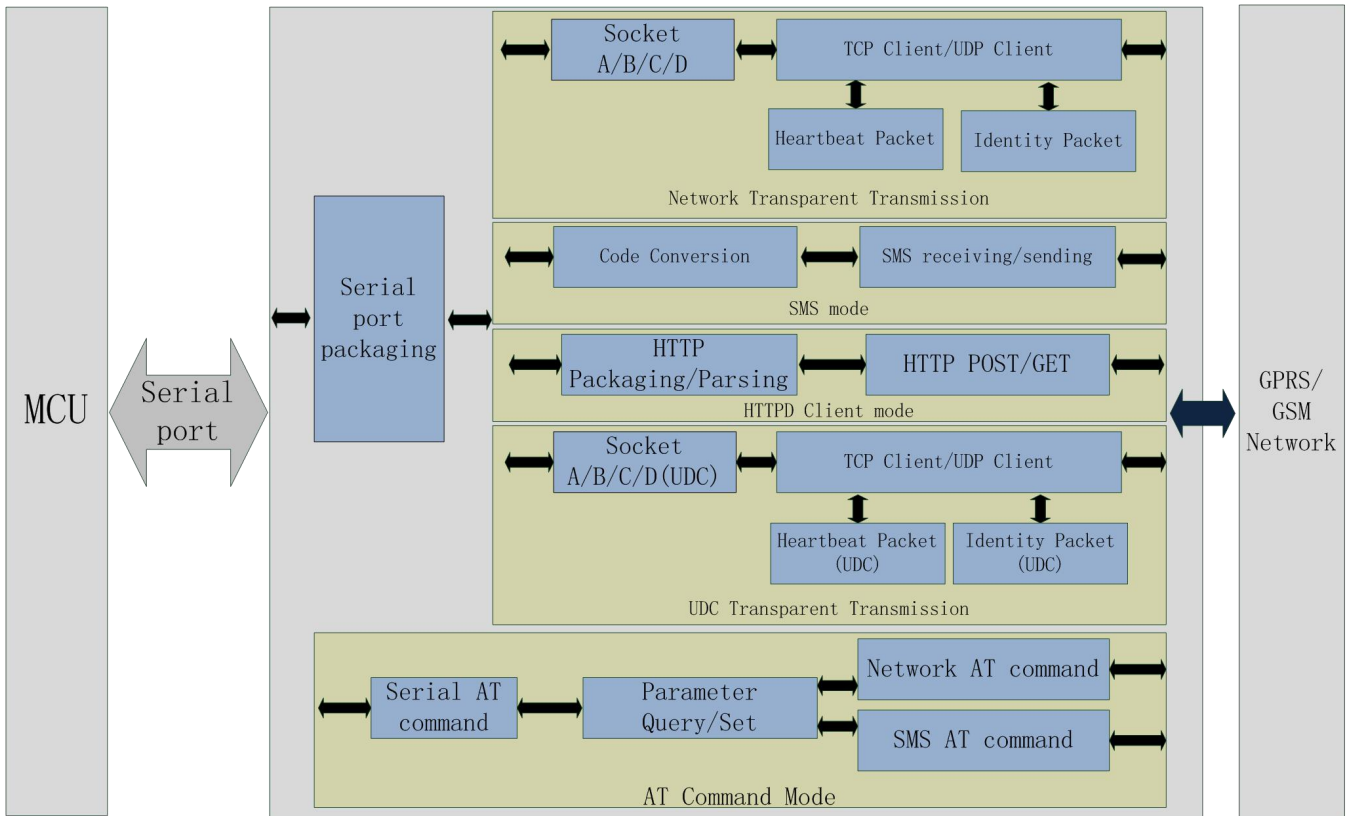

Figure 8 function diagram

2.1. APN

Different operator has different APN(access point name). If user use the SIM card from the operator, must know the APN. User can ask SIM card operator for APN.

There are three parameters about APN. Those are APN, username and password. Sometimes only configuring APN is enough.

2.2. Work Mode

2.2.1. Network transparent transmission mode

Network transparent transmission mode: Data from serial side will be forward to network server. The transmission is bidirectional.

Application diagram as follows:

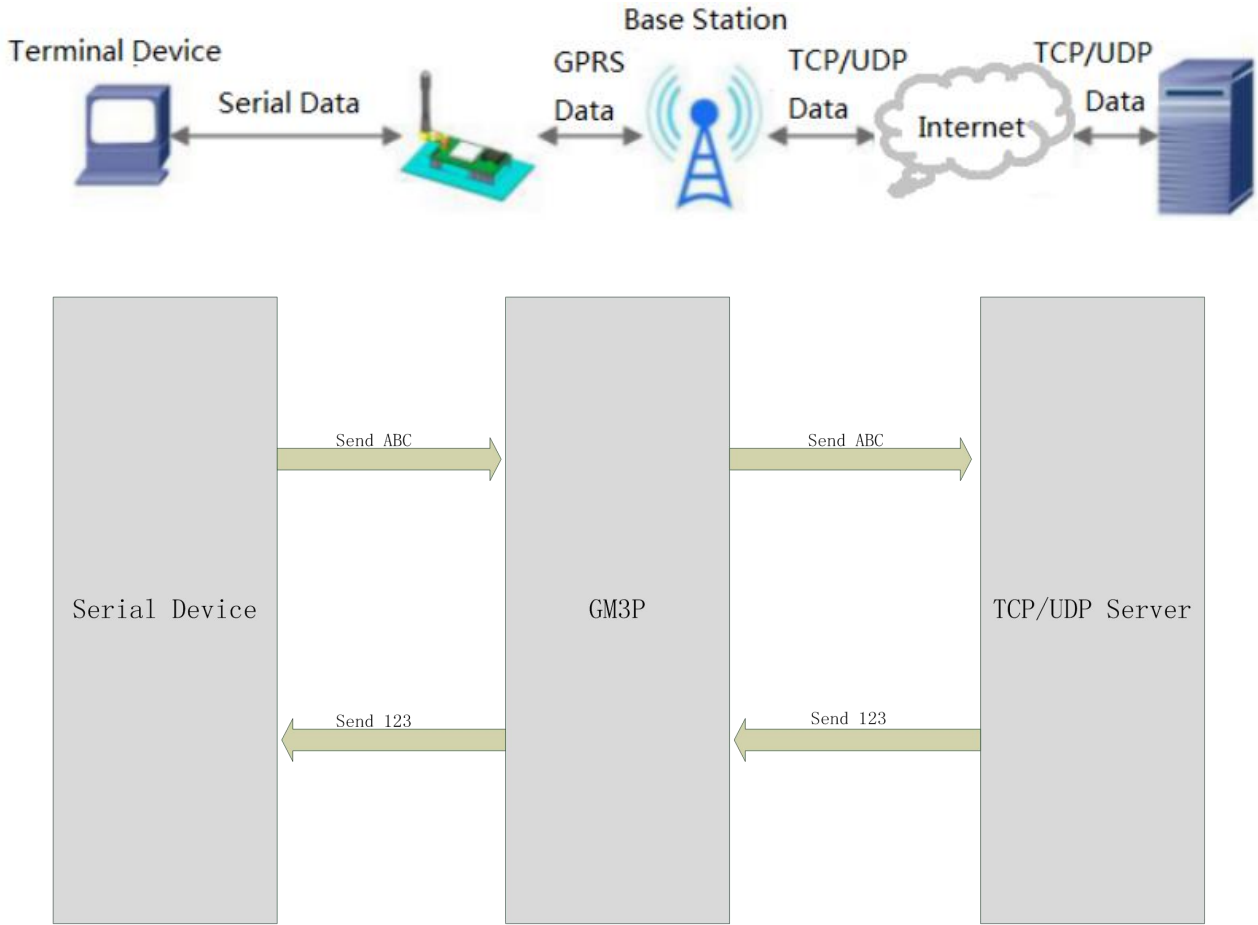

Figure 9 Network transparent transmission mode

<Illustration>:

USR-GM3P supports 4 socket connections simultaneously: socket A/B/C/D, they are independent. GM3P only support working as TCP Client and UDP Client.

2.2.2.HTTPD Client mode

HTTPD Client mode: GM3P will add the HTTP Header for every data from serial device and transfer HTTP format data to Network. User needs to configure the HTTP Header before use this mode. User can use this mode transfer the serial data to HTTP server.

Application diagram as follow:

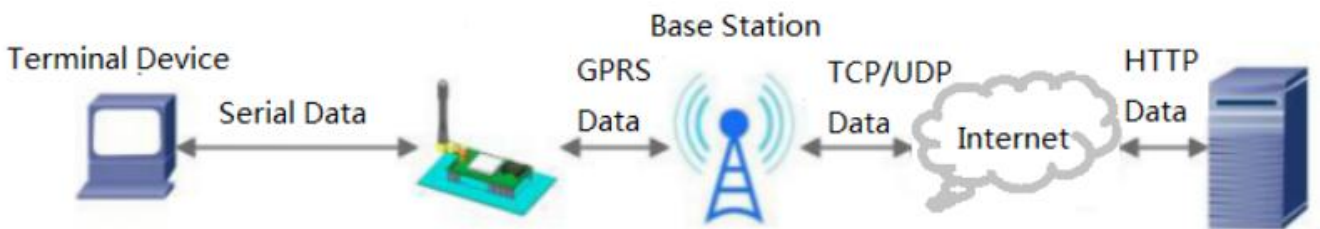

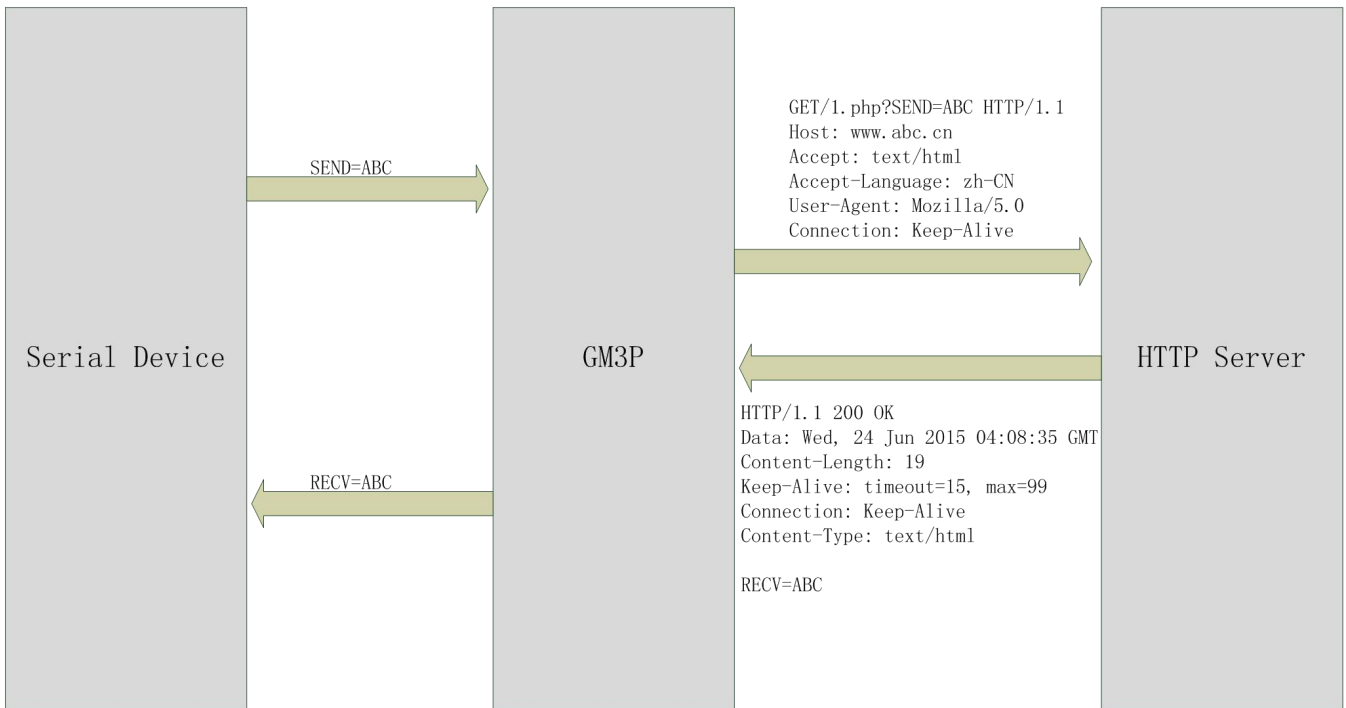

Figure 10 HTTPD Client mode

<Note>:

GM3P can't work as HTTP server.

2.2.3.SMS transparent transmission mode

SMS transparent transmission mode: Send serial data to mobile as SMS and receive SMS from mobile. The communication is bidirectional.

Application diagram as follows:

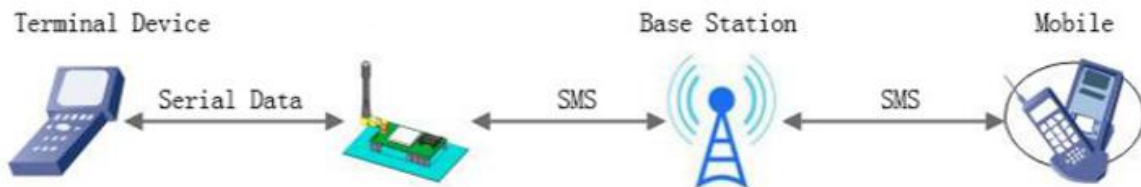

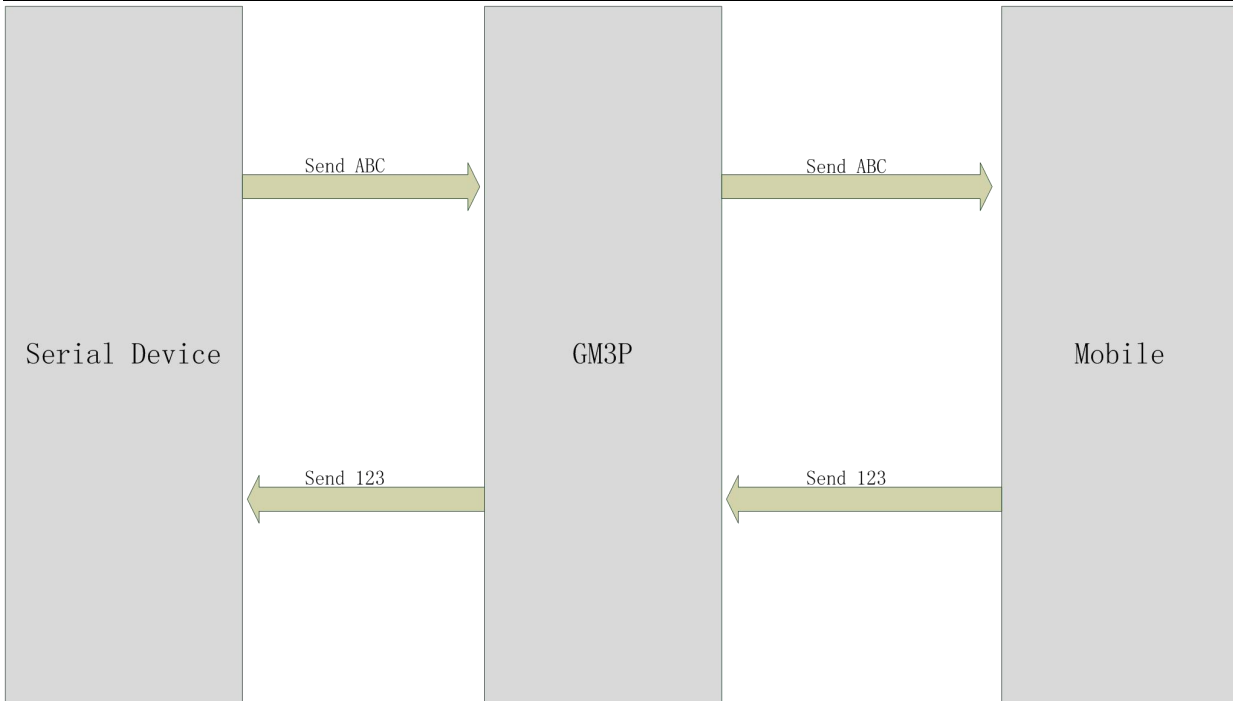

Figure 11 SMS transparent transmission mode

2.2.4.UDC transparent transmission mode

UDC transparent transmission mode: Add specific identity packet and heartbeat packet based on network transparent transmission mode, and will package data. In this mode, we provide secondary development packet in server side to help user in secondary development.

Application diagram as follows:

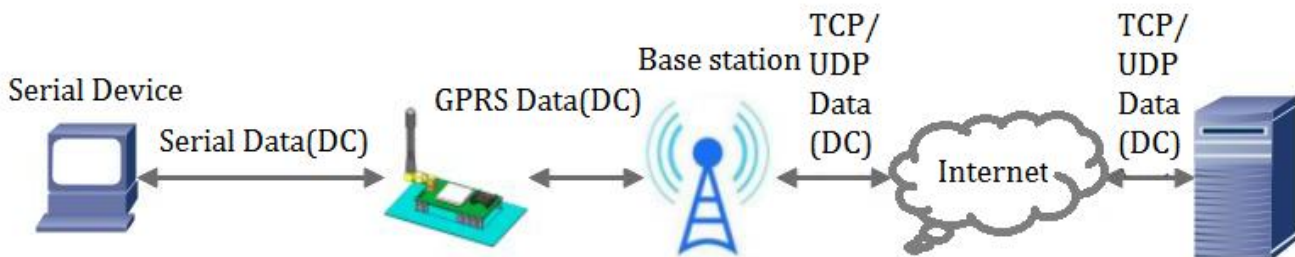

Figure 12 UDC transparent transmission mode

2.3. Serial Port

2.3.1. Basic Parameters

Parameters	Range
Baud Rate	1200, 2400, 4800, 9600, 14400, 19200, 38400, 57600, 115200, 128000, 230400, 460800, 921600
Data Bits	7, 8
Stop Bits	1, 2
Parity	NONE, EVEN, ODD
Flow Control/485	NFC: None Flow Control FC: Hardware Flow Control 485: When you use RS485, please choose this function

Figure 13 Serial parameters

2.3.2. Serial Package Methods

USR-GM3P adopts fixed Packaging time-200ms.

2.3.3. RS485

RS485 transfer time: For RS485 is half-duplex. It needs time to switch the status between sending & receiving. Switching period instructions:

Baud Rate	Switching period(ms)
2400	100
4800	40
9600	20
19200	15
28800	15
33600	15
38400	15
57600	15
115200	2
230400	2
460800	2
921600	2

Figure 14 Switching period

2.3.4. Baud Rate Synchronization

When module works with USR devices or software, serial parameters will change dynamically according to network protocol. User can modify serial parameters by sending data conformed to specific protocol via network. It is temporary, after resetting module, the parameters will back to original values.

2.4. Features

2.4.1. Identity Packet Function

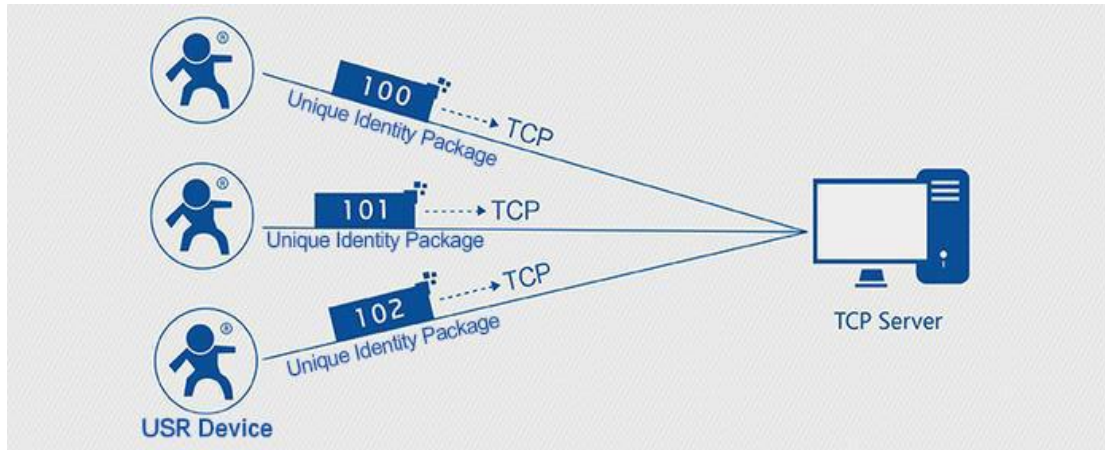

Figure 15 Identity packet

Identity packet is used to identify the device when module works as TCP client/UDP client. There are two methods for sending identity packet.

- Identity packet will be sent when connection is established. (Only for TCP client)
- Identity packet will be added on the front of every data package. (TCP client and UDP client)

Type of identity data: ICCID, IMEI, ID and user editable data.

2.4.2. Heartbeat Packet Function

Heartbeat packet: Module will output heartbeat data to serial port side or network side periodic. User can configure the heartbeat data and time interval. Serial heartbeat data can be used for polling Modbus data. Network heartbeat data can be used for showing connection status and keep the connection. When module send heartbeat packet unsuccessfully over three times, module will try to reconnect to server.

Heartbeat packet can only work in network transparent transmission mode.

2.4.3. Sleep mode

User can use the AT commands to set module into Sleep mode. In Sleep mode, module serial port side can't receive data but can transmit data; module can receive data from network or SMS. Even though module in Sleep mode can also keep TCP connection, but user can adopt non-persistent connection or close connection temporarily to make power dissipation arrive best status.

User can use Network AT commands, SMS AT commands, phone call or wake-up pin to wake up module.

2.4.4. Location Based Service

LBS function: User can acquire approximate location of module through operator 's network. Accuracy error is about 100 meters and user can acquire LBS information by AT commands.

2.4.5. GPS

GPS will get more accurate positioning information than LBS. To obtain the positioning information, user can send commands to query, or receive the GPRMC positioning information packet by periodic transparent transmission. In transparent transmission mode, user can select to send to network server or serial device, then get the positioning data according to GPRMC information format.

Application diagram as follow:

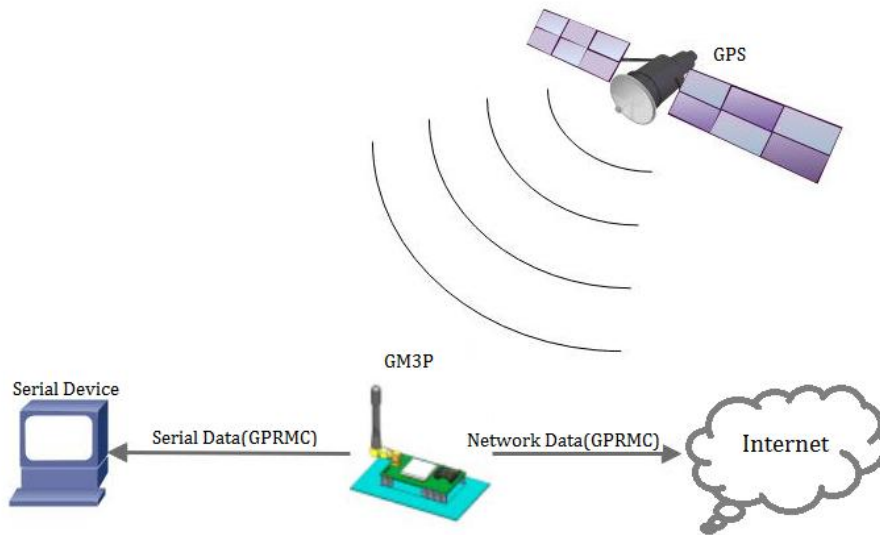

Figure 16 GPS

Note: When adopt GPS function, user need connecting external GPS antenna to GPS antenna interface and put module in the area where have GPS signal.

2.4.6. Upgrade firmware version

USR-GM3P supports upgrading firmware version through serial port. And user can ask salesperson for needed firmware file and upgrading tools when have needs to upgrade firmware version.

3. Parameter Setting

There are 3 ways to use AT commands for configuring module and querying status. They are serial AT command, SMS AT command and transparent AT command. We provide the setup software based on serial AT command. You can download the setup software from <http://www.usriot.com/usr-gm3-setup-software/>.

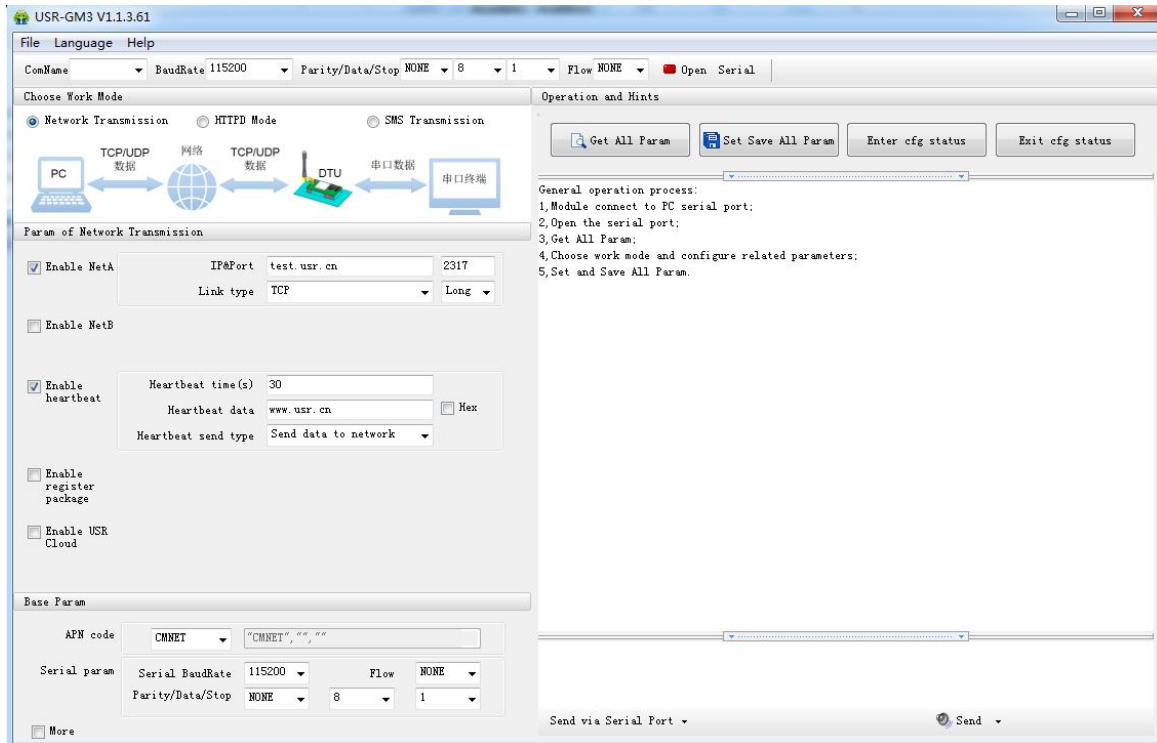

Figure 17 Setup software

3.1. AT Command

We have special manual for AT command.

3.1.1. Serial AT Command

In transparent mode, SMS mode and HTTPD mode, you can enter serial AT command mode. Then you can send AT command to module. Setup software is based on this function. For entering AT command mode, please refer to this FAQ: <http://www.usriot.com/enter-serial-command-mode/>.

3.1.2. Transparent AT Command

When module in transparent mode, you can use “Password,AT command” format to send AT command via serial or network. If you use transparent AT command, you needn’t enter AT command mode.

3.1.3. SMS AT Command

You can configure module or query status by SMS AT command. It is for your to remotely control your module in fields.

4. Contact Us

Company: Jinan USR IOT Technology Limited

Address: Floor 11, Building 1, No. 1166 Xinluo Street, Gaoxin District, Jinan, Shandong, 250101, China

Web: www.usriot.com

Support: h.usriot.com

Email: sales@usr.cn

Tel: 86-531-88826739/86-531-55507297

5. Disclaimer

This document provide the information of USR-GM3P products, it hasn't been granted any intellectual property license by forbidding speak or other ways either explicitly or implicitly. Except the duty declared in sales terms and conditions, we don't take any other responsibilities. We don't warrant the products sales and use explicitly or implicitly, including particular purpose merchant-ability and marketability, the tort liability of any other patent right, copyright, intellectual property right. We may modify specification and description at any time without prior notice.

6. Update History

2017-08-29 V1.0.0.01 established based on Chinese version V1.0.0.

2017-10-24 V1.0.0.02 updated based on Chinese version V1.0.0. Added product link, product picture, setup software download link and setup software screenshot. Modified some words to standards and corrected spelling/grammatical mistakes. Optimized whole manual arrangement.