

Data sheet | Item number: 770-1658

h-distribution connector; 2-pole; Cod. B; 1 input; 2 outputs; outputs on both sides; 3 locking levers; for flying leads; gray

www.wago.com/770-1658

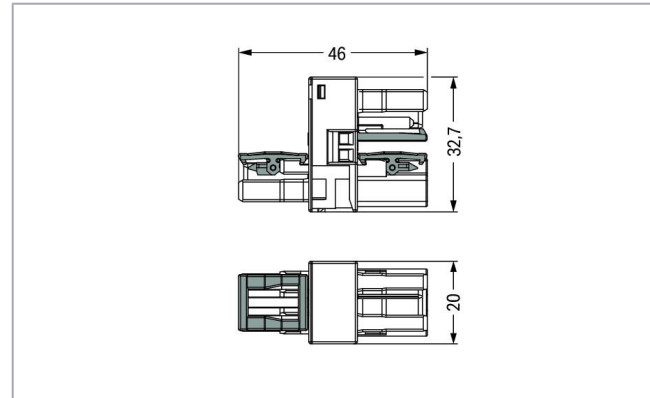
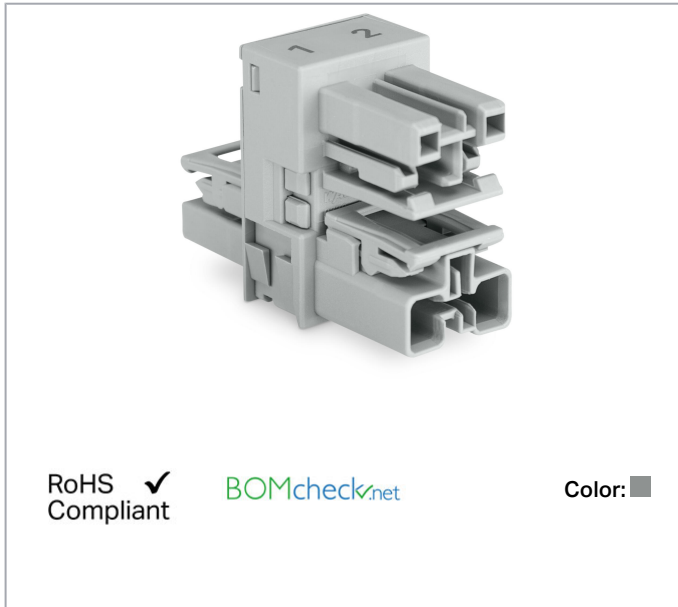

Item description

- Protected against mismatching and maintenance-free
- Components can be clearly printed on and color-coded to meet custom requirements.

Data

Electrical data

Note on contact resistance

approx. 1 mΩ of contact resistance approx. 0.25 mΩ contact transition plug/socket

Ratings per IEC/EN

Ratings per	IEC/EN 60664-1
Nominal voltage (III/3)	250 V
Rated surge voltage (III/3)	4 kV
Rated current	25 A
Legend (ratings)	(III / 3) ≙ Overvoltage category III / Pollution degree 3

Subject to changes. Please also observe the further product documentation!

WAGO Kontakttechnik GmbH & Co. KG
Hansastr. 27
32423 Minden
Phone: +49571 887-0 | Fax: +49571 887-169
Email: info.de@wago.com | Web: www.wago.com

Do you have any questions about our products?
We are always happy to take your call at +49 (571) 887-44222.



Ratings per UL

Hinweis für den amerikanischen Markt

Application note for the U.S. market (USR): Some versions may also be used for current interruption in accordance with the UL certificate in select applications with currents below 16 A and voltages up to 600 V. For further information, please contact your local sales office.

Rated voltage UL 1977	600 V
Rated current UL 1977	23 A

Connection data

Pole No.	2
Total number of potentials	2

Physical data

Pin spacing	10 mm / 0.394 inch
Width	20 mm / 0.787 inch
Height	32.7 mm / 1.287 inch
Depth	51 mm / 2.008 inch

Mechanical data

Application	Measurement and regulation technology
Coding	B
Marking	1 2
Potential marking	1 2
Mating force of a plug-in connection	approx. 20 ... 70 N (depending on pole number)
Retention force of a plug-in connection	When locked: > 80 N
Unmating force of a plug-in connection	Unlocked: approx. 20 ... 70 N (depending on pole number)
Number of mating cycles	200, without resistive load
Distributor type	h-distribution connector (bi-directional)
Protection type	IP20
Note on protection type	When mated: IP2xC (These compact connectors are not designed for use in open, easily accessible areas!)
Suitable	for flying leads

Plug-in connection

Contact type (pluggable connector)	Socket/plug
------------------------------------	-------------

Subject to changes. Please also observe the further product documentation!

Mismating protection	Yes
Note on mismating protection	All WINSTA [®] components are 100% protected against mismating when: a.) plugging different numbers of poles b.) plugging while rotated 180 c.) plugging while laterally staggered d.) plugging one pole
Locking lever	yes
Locking of plug-in connection	locking lever
Hinweis zur Verriegelung	All connectors for mounted installations (snap-in versions for lighting fixtures or devices, all types of PCB and distribution connectors) are factory-equipped with locking levers to ensure plugs and sockets are securely locked. Additional locking levers are only required for flying leads (plug/socket).

Material data

Color	gray
Insulation material	Polyamide (PA66)
Contact material	Copper or copper alloy (surface-treated)
Weight	14.8 g

Environmental requirements

Processing temperature	-5 ... +40 °C
Continuous operating temperature	-35 ... +85 °C
Note on continuous operating temperature	Insulating parts for temperatures ≤ 105 °C

Commercial data

Packaging type	BOX
Country of origin	DE
GTIN	4055143561822
Customs tariff number	85366990990





Approvals / Certificates

UL-Approvals

Logo	Approval	Additional Approval Text	Certificate name
	cURus Underwriters Laboratories Inc.	UL 1977	E45171 Sec. 9



Subject to changes. Please also observe the further product documentation!

Counterpart



	Item no.770-242 Socket; 2-pole; Cod. B; 4,00 mm ² ; gray	www.wago.com/770-242
	Item no.770-252 Plug; 2-pole; Cod. B; 4,00 mm ² ; gray	www.wago.com/770-252
	Item no.771-8992/005-103 pre-assembled interconnecting cable; Socket/plug; 2-pole; Cod. B; Control cable 2 x 1.0 mm ² ; 1 m; 1,00 mm ² ; gray	www.wago.com/771-8992/005-103
	Item no.771-8992/105-103 pre-assembled connecting cable; Socket/open-ended; 2-pole; Cod. B; Control cable 2 x 1.0 mm ² ; 1 m; 1,00 mm ² ; gray	www.wago.com/771-8992/105-103
	Item no.771-8992/205-103 pre-assembled connecting cable; Plug/open-ended; 2-pole; Cod. B; Control cable 2 x 1.0 mm ² ; 1 m; 1,00 mm ² ; gray	www.wago.com/771-8992/205-103

Required accessories

protection

	Item no.: 770-201 Lockout cap; 12-pole, separable; 12-pole; for sockets; black	www.wago.com/770-201
	Item no.: 770-221 Lockout cap; for socket; 12-pole; separable; white	www.wago.com/770-221
	Item no.: 770-360 Lockout cap; for plugs; 5-pole; separable; yellow	www.wago.com/770-360

assembling

	Item no.: 770-1626 Mounting plate; 2-pole; for distribution connectors; Plastic; black	www.wago.com/770-1626
	Item no.: 770-1627 Mounting plate; 2-pole; for distribution connectors; Plastic; white	www.wago.com/770-1627

Downloads

Documentation

Bid Text

770-1658 doc - Datei	13. 4. 2017	doc 23.6 kB	Download
770-1658	19. 2. 2019	xml 2.9 kB	Download

Subject to changes. Please also observe the further product documentation!

Environmental Product Compliance

Compliance Search

Environmental Product Compliance 770-1658

URL

Download

h-distribution connector; 2-pole; Cod. B; 1 input; 2 outputs; outputs on both sides; 3 locking levers; for flying leads; gray

Installation Notes

Installation

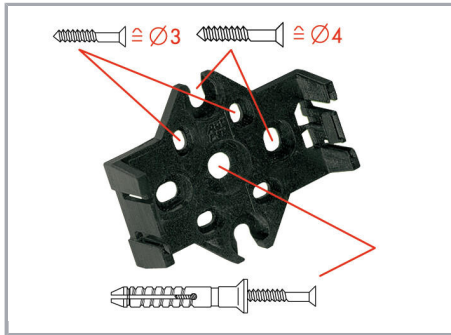

Mounting plates can be secured using commercially available screws or nail-drive anchors.



The distribution connectors snap together when attached to the mounting plate.



To release the distribution connector, unlock the latch using a screwdriver.

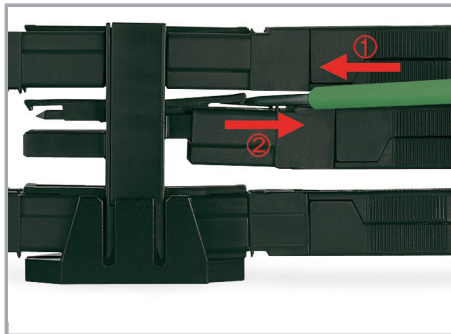

All distribution connector connections are locked and protected against accidental disconnection directly after mating. Locking of any connection is released using a screwdriver, even if all connections are used.

Subject to changes. Please also observe the further product documentation!

Data sheet | Item number: 770-1658

www.wago.com/770-1658



Product family

WINSTA® MIDI

[Show all products from the family](#)

Subject to changes. Please also observe the further product documentation!

WAGO Kontakttechnik GmbH & Co. KG
Hansastr. 27
32423 Minden
Phone: +49571 887-0 | Fax: +49571 887-169
Email: info.de@wago.com | Web: www.wago.com

Do you have any questions about our products?
We are always happy to take your call at +49 (571) 887-44222.