

Data sheet | Item number: 2604-3104

PCB terminal block; lever; 4 mm²; Pin spacing 5 mm; 4-pole; Push-in CAGE CLAMP®; 4,00 mm²; gray

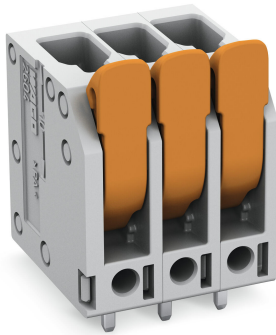

www.wago.com/2604-3104



i Picture differs from the item.

RoHS Compliant

Color:

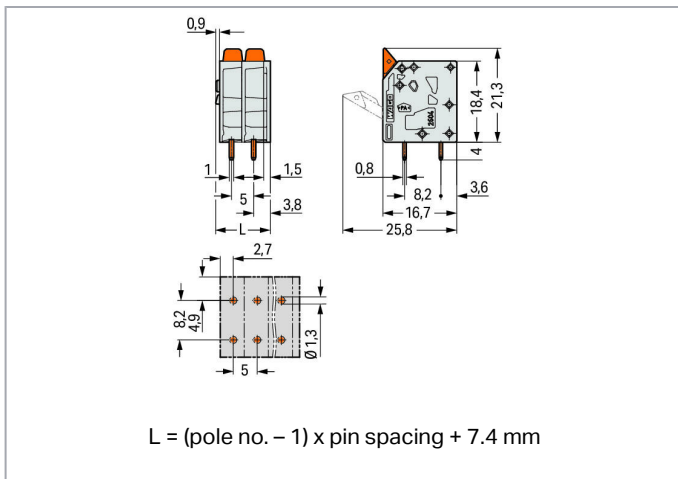
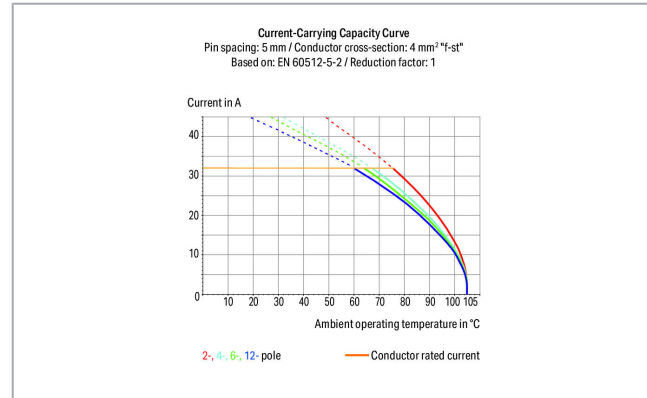

Item description

- PCB terminal blocks with levers and Push-in CAGE CLAMP® connection
- Push-in termination of solid and ferruled conductors
- Intuitive and tool-free operation

Subject to changes. Please also observe the further product documentation!

WAGO Kontakttechnik GmbH & Co. KG
Hansastr. 27
32423 Minden
Phone: +49571 887-0 | Fax: +49571 887-169
Email: info.de@wago.com | Web: www.wago.com

Do you have any questions about our products?
We are always happy to take your call at +49 (571) 887-44222.



- Several clamping units can be held open simultaneously – convenient for terminating multi-core cables
- Testing can be performed both parallel and perpendicular to conductor entry

Data

Electrical data

Ratings per IEC/EN

| Ratings per | IEC/EN 60664-1 |
|-----------------------------|---|
| Nominal voltage (III/3) | 320 V |
| Rated surge voltage (III/3) | 4 kV |
| Rated voltage (III/2) | 400 V |
| Rated surge voltage (III/2) | 4 kV |
| Nominal voltage (II/2) | 630 V |
| Rated surge voltage (II/2) | 4 kV |
| Rated current | 32 A |
| Legend (ratings) | (III / 2) $\hat{=}$ Overvoltage category III / Pollution degree 2 |

Ratings per UL

| Approvals per | UL 1059 |
|--------------------------------|---------|
| Rated voltage UL (Use Group B) | 300 V |
| Rated current UL (Use Group B) | 20 A |
| Rated voltage UL (Use Group D) | 300 V |
| Rated current UL (Use Group D) | 10 A |

Ratings per CSA

| Approvals per | CSA |
|---------------------------------|-------|
| Rated voltage CSA (Use Group B) | 300 V |
| Rated current CSA (Use Group B) | 20 A |
| Rated voltage CSA (Use Group D) | 300 V |
| Rated current CSA (Use Group D) | 5 A |

Connection data

| | |
|-------------------------|---|
| Connection technology | Push-in CAGE CLAMP® |
| Actuation type | Lever |
| Solid conductor | 0.2 ... 4 mm ² / 24 ... 12 AWG |
| Fine-stranded conductor | 0.2 ... 4 mm ² / 24 ... 12 AWG |

Subject to changes. Please also observe the further product documentation!



| | |
|---|----------------------------------|
| Fine-stranded conductor; with insulated ferrule | 0.25 ... 2.5 mm ² |
| Fine-stranded conductor; with uninsulated ferrule | 0.25 ... 2.5 mm ² |
| Fine-stranded conductor; with twin ferrule | 0.25 ... 1.5 mm ² |
| Strip length | 9 ... 11 mm / 0.35 ... 0.43 inch |
| Conductor connection direction to PCB | 90° |
| Pole No. | 4 |
| Total number of connection points | 4 |
| Total number of potentials | 4 |
| Number of connection types | 1 |
| Number of levels | 1 |

Physical data

| | |
|--------------------------------------|--------------------------|
| Pin spacing | 5 mm / 0.197 inch |
| Width | 22.4 mm / 0.882 inch |
| Height | 25.3 mm / 0.996 inch |
| Height from the surface | 21.3 mm / 0.839 inch |
| Depth | 16.7 mm / 0.657 inch |
| Solder pin length | 4 mm |
| Solder pin dimensions | 0.8 x 1 mm |
| Drilled hole diameter with tolerance | 1.3 ^(+0.1) mm |

PCB contact

| | |
|-------------------------------------|--|
| PCB Contact | THT |
| Solder pin arrangement | over the entire terminal strip (in-line) |
| Number of solder pins per potential | 2 |

Material data

| | |
|-----------------------------|--|
| Color | gray |
| Material group | I |
| Insulation material | Polyamide (PA66) |
| Flammability class per UL94 | V0 |
| Clamping spring material | Chrome nickel spring steel (CrNi) |
| Contact material | Electrolytic copper (E _{Cu}) |
| Contact plating | tin-plated |
| Color of actuator | orange |
| Weight | 6.8 g |

Subject to changes. Please also observe the further product documentation!

Environmental requirements



| | |
|-------------------------|-----------------|
| Limit temperature range | -60 ... +105 °C |
|-------------------------|-----------------|

Commercial data

| | |
|-----------------------|---------------|
| Packaging type | BOX |
| Country of origin | DE |
| GTIN | 4055143564731 |
| Customs tariff number | 85369010000 |

Approvals / Certificates

Country specific Approvals



| Logo | Approval | Additional Approval Text | Certificate name |
|--|--|--------------------------|------------------|
| | CB DEKRA Certification B.V. | EN 60947-7-4 | NL-47057 |
|  | CSA DEKRA Certification B.V. | C22.2 No. 158 | 70117145 |
|  | KEMA/KEUR DEKRA Certification B.V. | EN 60947-7-4 | 71-100535 |

UL-Approvals

| Logo | Approval | Additional Approval Text | Certificate name |
|--|--|--------------------------|------------------|
|  | cURus Underwriters Laboratories Inc. | UL 1059 | E45172 |





Compatible products

ferrule

| | | |
|--|--|--|
|  | Item no.: 216-106 Ferrule; Sleeve for 2.5 mm ² / AWG 14; uninsulated; electro-tin plated; silver-colored | www.wago.com/216-106 |
|  | Item no.: 216-241 Ferrule; Sleeve for 0.5 mm ² / 20 AWG; insulated; electro-tin plated; electrolytic copper; gastight crimped; acc. to DIN 46228, Part 4/09.90; white | www.wago.com/216-241 |

Subject to changes. Please also observe the further product documentation!



| | | |
|---|--|--|
|  | Item no.: 216-242 Ferrule; Sleeve for 0.75 mm ² / 18 AWG; insulated; electro-tin plated; electrolytic copper; gastight crimped; acc. to DIN 46228, Part 4/09.90; gray | www.wago.com/216-242 |
|  | Item no.: 216-243 Ferrule; Sleeve for 1 mm ² / AWG 18; insulated; electro-tin plated; electrolytic copper; gastight crimped; acc. to DIN 46228, Part 4/09.90; red | www.wago.com/216-243 |
|  | Item no.: 216-244 Ferrule; Sleeve for 1.5 mm ² / AWG 16; insulated; electro-tin plated; electrolytic copper; gastight crimped; acc. to DIN 46228, Part 4/09.90; black | www.wago.com/216-244 |
|  | Item no.: 216-246 Ferrule; Sleeve for 2.5 mm ² / AWG 14; insulated; electro-tin plated; electrolytic copper; gastight crimped; acc. to DIN 46228, Part 4/09.90; blue | www.wago.com/216-246 |

Downloads

Documentation

Additional Information

| | | | |
|------------------------|------------|---------------|----------|
| Technical explanations | 3. 4. 2019 | pdf 2.0 MB | Download |
|------------------------|------------|---------------|----------|

CAD/CAE-Data

CAD data

| | | |
|------------------------|-----|----------|
| 2D/3D Models 2604-3104 | URL | Download |
|------------------------|-----|----------|

PCB Design

| | | |
|--------------------------------|-----|----------|
| Symbol and Footprint 2604-3104 | URL | Download |
|--------------------------------|-----|----------|

CAX data for your PCB design, consisting of "schematic symbols and PCB footprints", allow easy integration of the WAGO component into your development environment.

Supported formats:

- Accel EDA 14 & 15
- Altium 6 to current version
- Cadence Allegro
- DesignSpark
- Eagle Libraries
- KiCad
- Mentor Graphics BoardStation
- Mentor Graphics Design Architect
- Mentor Graphics Design Expedition 99 and 2000

Subject to changes. Please also observe the further product documentation!



- OrCAD 9.X PCB and Capture
- PADS PowerPCB 3, 3.5, 4.X, and 5.X
- PADS PowerPCB and PowerLogic 3.0
- PCAD 2000, 2001, 2002, 2004, and 2006
- Pulsonix 8.5 or newer
- STL
- 3D STEP
- TARGET 3001!
- View Logic ViewDraw
- Quadcept
- Zuken CadStar 3 and 4
- Zuken CR-5000 and CR-8000

PCB Component Libraries (EDA), PCB CAD Library Ultra Librarian

CAE data

| | | |
|------------------------|-----|----------|
| ZUKEN Portal 2604-3104 | URL | Download |
|------------------------|-----|----------|

Environmental Product Compliance

Compliance Search

| | | |
|--|-----|----------|
| Environmental Product Compliance 2604-3104 PCB terminal block; lever; 4 mm ² ; Pin spacing 5 mm; 4-pole; Push-in CAGE CLAMP®; 4,00 mm ² ; gray | URL | Download |
|--|-----|----------|

Installation Notes

Subject to changes. Please also observe the further product documentation!