

# Data sheet | Item number: 899-631/450-000

Distribution box; supply cable entry; 6 outputs; Cod. A; MIDI; black

[www.wago.com/899-631/450-000](http://www.wago.com/899-631/450-000)

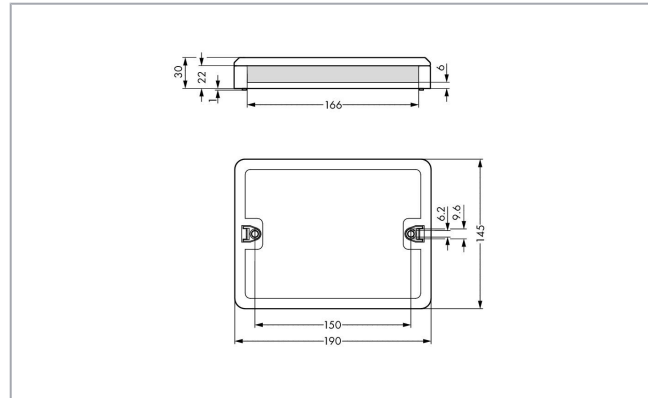
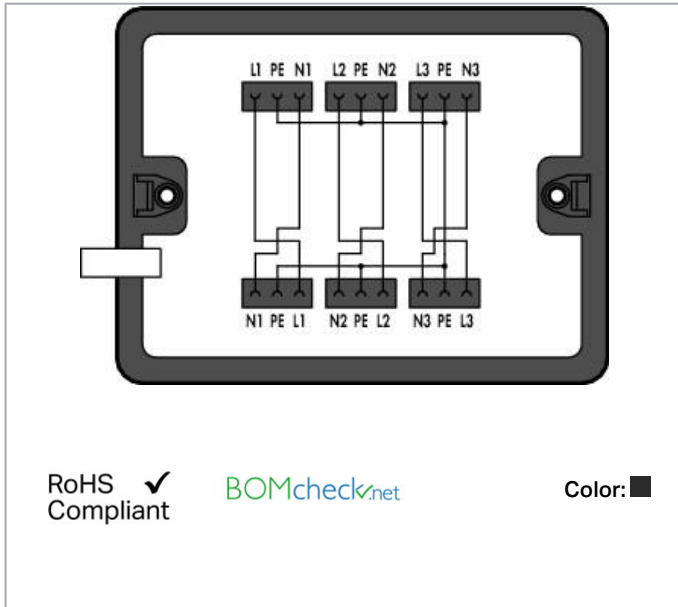

## Item description

Power supply is performed directly via connectors using a 7-pole cable. Each phase of the 3-phase current are divided into two outputs. Power supply is performed to the left or to the right.

Includes: Two cable clamps and four mounting screws

## Data

### Electrical data

Note on contact resistance

approx. 1 mΩ of contact resistance approx. 0.25 mΩ contact transition plug/socket

### Ratings per IEC/EN

Ratings per	IEC/EN 60664-1
Nominal voltage (III/3)	400 V
Rated surge voltage (III/3)	6 kV
Rated current	25 A
Rated voltage (III/3) 2	250 V
Rated surge voltage (III/3) 2	4 kV

Subject to changes. Please also observe the further product documentation!

WAGO Kontakttechnik GmbH & Co. KG  
Hansastr. 27  
32423 Minden  
Phone: +49571 887-0 | Fax: +49571 887-169  
Email: [info.de@wago.com](mailto:info.de@wago.com) | Web: [www.wago.com](http://www.wago.com)

Do you have any questions about our products?  
We are always happy to take your call at +49 (571) 887-44222.



Legend (ratings)

(III / 3) ≙ Overvoltage category III / Pollution degree 3

## Physical data

Width	190 mm / 7.48 inch
Height	30 mm / 1.181 inch
Depth	145 mm / 5.709 inch

## Mechanical data

Internal wiring	4 mm <sup>2</sup>
Application	General mains applications
Coding	A
Mounting type	Wall, screw mount Installation on mounting plate
Protection type	IP20
Note on protection type	When mated: IP2xC (These compact connectors are not designed for use in open, easily accessible areas!)

## Plug-in connection

Mismating protection	Yes
Note on mismating protection	All WINSTA <sup>®</sup> components are 100% protected against mismating when: a.) plugging different numbers of poles b.) plugging while rotated 180 c.) plugging while laterally staggered d.) plugging one pole
Locking of plug-in connection	locking lever

## Material data

Color	black
Insulation material	Polyamide (PA66)
Contact material	Copper or copper alloy (surface-treated)
Fire load	6.859 MJ
Weight	383.2 g

## Environmental requirements

Processing temperature	-5 ... +40 °C
Continuous operating temperature	-35 ... +85 °C
Note on continuous operating temperature	Insulating parts for temperatures ≤ 105 °C

Subject to changes. Please also observe the further product documentation!





WAGO Kontakttechnik GmbH & Co. KG  
 Hansastr. 27  
 32423 Minden  
 Phone: +49571 887-0 | Fax: +49571 887-169  
 Email: [info.de@wago.com](mailto:info.de@wago.com) | Web: [www.wago.com](http://www.wago.com)

Do you have any questions about our products?  
 We are always happy to take your call at +49 (571) 887-44222.

## Commercial data

Packaging type	BOX
Country of origin	DE
GTIN	4055143305945
Customs tariff number	85366990990

## Counterpart

	<b>Item no.770-113</b> Plug; with strain relief housing; 3-pole; Cod. A; 4,00 mm <sup>2</sup> ; black	<a href="http://www.wago.com/770-113">www.wago.com/770-113</a>
	<b>Item no.770-213</b> Plug; 3-pole; Cod. A; 4,00 mm <sup>2</sup> ; black	<a href="http://www.wago.com/770-213">www.wago.com/770-213</a>
	<b>Item no.770-213/035-000</b> Plug; with strain relief housing; 3-pole; Cod. A; 4,00 mm <sup>2</sup> ; black	<a href="http://www.wago.com/770-213/035-000">www.wago.com/770-213/035-000</a>
	<b>Item no.771-9993/206-101</b> pre-assembled connecting cable; Eca; Plug/open-ended; 3-pole; Cod. A; H05VV-F 3G 1.5 mm <sup>2</sup> ; 1 m; 1,50 mm <sup>2</sup> ; black	<a href="http://www.wago.com/771-9993/206-101">www.wago.com/771-9993/206-101</a>
	<b>Item no.771-9993/006-101</b> pre-assembled interconnecting cable; Eca; Socket/plug; 3-pole; Cod. A; H05VV-F 3G 1.5 mm <sup>2</sup> ; 1 m; 1,50 mm <sup>2</sup> ; black	<a href="http://www.wago.com/771-9993/006-101">www.wago.com/771-9993/006-101</a>

## Compatible products

### assembling

	<b>Item no.: 770-680</b> Mounting plate; for distribution boxes	<a href="http://www.wago.com/770-680">www.wago.com/770-680</a>
--	--	--

## Downloads

### Documentation

#### Bid Text

899-631/450-000 doc - Datei	23. 2. 2015	doc 26.1 kB	Download
899-631/450-000 X81 - Datei	19. 2. 2019	xml 3.8 kB	Download

Subject to changes. Please also observe the further product documentation!

## Environmental Product Compliance

### Compliance Search

Environmental Product Compliance 899-631/450-000

URL

Download

Distribution box; supply cable entry; 6 outputs; Cod. A; MIDI; black

---

## Installation Notes

### Installation



Securing the mounting plate with WINSTA®  
Distribution Box to the wall (e.g., via stud gun).

## Product family

### *WINSTA*® Boxen

WINSTA® ist das Steckverbindersystem, das optimal auf die hohen Anforderungen in der Gebäudeinstallation zugeschnitten ist. Es macht die Elektroinstallation steckbar und dadurch schnell, sicher und fehlerfrei. Dies gilt auch in weiteren Anwendungen wie z. B. im Schiffbau, in der Bahntechnik oder in der Industrie.

[Show all products from the family](#)

Subject to changes. Please also observe the further product documentation!