

Data sheet | Item number: 232-150/039-000

THT female header; 0.6 x 1.0 mm solder pin; straight; Locking lever; 2.5 mm²;
Pin spacing 5 mm; 20-pole; gray

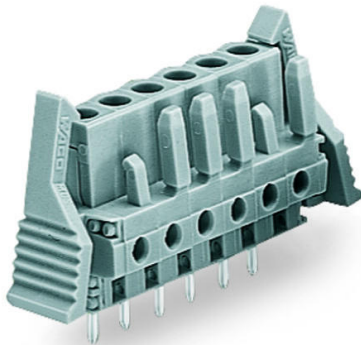

www.wago.com/232-150/039-000



i Picture differs from the item.

RoHS Compliant

[BOMcheck.net](https://www.bomcheck.net)

Color:

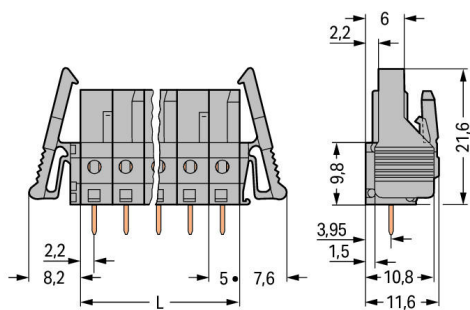
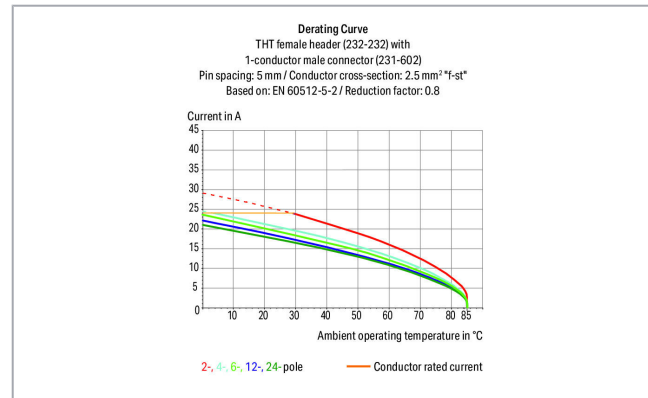

L = pole no. x pin spacing

2- to 3-pole female connectors – one latch only

Item description

- Horizontal or vertical PCB mounting via straight or angled solder pins
- For board-to-board and board-to-wire connections

Subject to changes. Please also observe the further product documentation!

WAGO Kontakttechnik GmbH & Co. KG

Hansastr. 27

32423 Minden

Phone: +49571 887-0 | Fax: +49571 887-169

Email: info.de@wago.com | Web: www.wago.com

Do you have any questions about our products?

We are always happy to take your call at +49 (571) 887-44222.



- Touch-proof PCB outputs
- Easy-to-identify PCB inputs and outputs
- With coding fingers

Safety information 1:

The *MCS – MULTI CONNECTION SYSTEM* includes connectors without breaking capacity in accordance with DIN EN 61984. When used as intended, these connectors must not be connected/disconnected when live or under load. The circuit design should ensure header pins, which can be touched, are not live when unmated.

Data**Electrical data****Ratings per IEC/EN**

| Ratings per | IEC/EN 60664-1 |
|-----------------------------|---|
| Nominal voltage (III/3) | 320 V |
| Rated surge voltage (III/3) | 4 kV |
| Rated voltage (III/2) | 320 V |
| Rated surge voltage (III/2) | 4 kV |
| Nominal voltage (II/2) | 630 V |
| Rated surge voltage (II/2) | 4 kV |
| Rated current | 12 A |
| Legend (ratings) | (III / 2) ≙ Overvoltage category III / Pollution degree 2 |

Ratings per UL

| Approvals per | UL 1059 |
|--------------------------------|---------|
| Rated voltage UL (Use Group B) | 300 V |
| Rated current UL (Use Group B) | 15 A |
| Rated voltage UL (Use Group D) | 300 V |
| Rated current UL (Use Group D) | 10 A |

Ratings per UL

| | |
|-----------------------|-------|
| Rated voltage UL 1977 | 600 V |
| Rated current UL 1977 | 15 A |

Ratings per CSA

| Approvals per | CSA |
|---------------------------------|-------|
| Rated voltage CSA (Use Group B) | 300 V |

Subject to changes. Please also observe the further product documentation!

WAGO Kontakttechnik GmbH & Co. KG
 Hansastr. 27
 32423 Minden
 Phone: +49571 887-0 | Fax: +49571 887-169
 Email: info.de@wago.com | Web: www.wago.com

Do you have any questions about our products?
 We are always happy to take your call at +49 (571) 887-44222.



| | |
|---------------------------------|-------|
| Rated current CSA (Use Group B) | 15 A |
| Rated voltage CSA (Use Group D) | 300 V |
| Rated current CSA (Use Group D) | 10 A |

Connection data

| | |
|----------------------------|----|
| Pole No. | 20 |
| Total number of potentials | 20 |
| Number of connection types | 1 |
| Number of levels | 1 |

Physical data

| | |
|--------------------------------------|--------------------------|
| Pin spacing | 5 mm / 0.197 inch |
| Width | 115.8 mm / 4.559 inch |
| Height | 26.6 mm / 1.047 inch |
| Height from the surface | 21.6 mm / 0.85 inch |
| Depth | 11.6 mm / 0.457 inch |
| Solder pin length | 5 mm |
| Solder pin dimensions | 0.6 x 1 mm |
| Drilled hole diameter with tolerance | 1.3 ^(+0.1) mm |

Plug-in connection

| | |
|------------------------------------|-------------------------|
| Contact type (pluggable connector) | Female connector/socket |
| Connector (connection type) | for PCB |
| Mismating protection | No |
| Mating direction to the PCB | 90° |
| Locking of plug-in connection | locking lever |

PCB contact

| | |
|-------------------------------------|--|
| PCB Contact | THT |
| Solder pin arrangement | over the entire female connector (in-line) |
| Number of solder pins per potential | 1 |

Material data

| | |
|---------------------|------------------|
| Color | gray |
| Material group | I |
| Insulation material | Polyamide (PA66) |

Subject to changes. Please also observe the further product documentation!

| | |
|-----------------------------|--------------|
| Flammability class per UL94 | V0 |
| Contact material | Copper alloy |
| Contact plating | tin-plated |
| Weight | 19.3 g |

Environmental requirements

| | |
|-------------------------|----------------|
| Limit temperature range | -60 ... +85 °C |
|-------------------------|----------------|

Commercial data





| | |
|-----------------------|---------------|
| Packaging type | BOX |
| Country of origin | DE |
| GTIN | 4055143760041 |
| Customs tariff number | 85366990990 |

Approvals / Certificates

Country specific Approvals

| Logo | Approval | Additional Approval Text | Certificate name |
|---|---------------------------------|--------------------------|------------------|
|  | CSA DEKRA Certification B.V. | C22.2 | 1466354 |

Ship Approvals

| Logo | Approval | Additional Approval Text | Certificate name |
|--|--|--------------------------|---------------------------|
|  | ABS American Bureau of Shipping | - | 19- HG15869876- PDA |
|   | BV Bureau Veritas S.A. | IEC 60998 | 11915/D0 BV |
|  | DNV GL Det Norske Veritas, Germanischer Lloyd | - | TAE 000016Z |

UL-Approvals

Certificate

Subject to changes. Please also observe the further product documentation!

| Logo | Approval | Additional Approval Text | name |
|--|--------------------------------------|--------------------------|---------------------|
|  | UL Underwriters Laboratories Inc. | UL 1059 | 20190731- E45172 |

Counterpart



Item no.231-620

1-conductor male connector; 2.5 mm²; Pin spacing 5 mm; 20-pole; 2,50 mm²; gray

www.wago.com/231-620

Downloads

Documentation

Additional Information

| | | | |
|------------------------|------------|---------------|----------|
| Technical explanations | 3. 4. 2019 | pdf 2.0 MB | Download |
|------------------------|------------|---------------|----------|

CAD/CAE-Data

CAD data

| | | |
|------------------------------|-----|----------|
| 2D/3D Models 232-150/039-000 | URL | Download |
|------------------------------|-----|----------|

PCB Design

| | | |
|--------------------------------------|-----|----------|
| Symbol and Footprint 232-150/039-000 | URL | Download |
|--------------------------------------|-----|----------|

CAX data for your PCB design, consisting of "schematic symbols and PCB footprints", allow easy integration of the WAGO component into your development environment.

Supported formats:

- Accel EDA 14 & 15
- Altium 6 to current version
- Cadence Allegro
- DesignSpark
- Eagle Libraries
- KiCad
- Mentor Graphics BoardStation
- Mentor Graphics Design Architect

—
Subject to changes. Please also observe the further product documentation!



- Mentor Graphics Design Expedition 99 and 2000
- OrCAD 9.X PCB and Capture
- PADS PowerPCB 3, 3.5, 4.X, and 5.X
- PADS PowerPCB and PowerLogic 3.0
- PCAD 2000, 2001, 2002, 2004, and 2006
- Pulsonix 8.5 or newer
- STL
- 3D STEP
- TARGET 3001!
- View Logic ViewDraw
- Quadcept
- Zuken CadStar 3 and 4
- Zuken CR-5000 and CR-8000

PCB Component Libraries (EDA), PCB CAD Library Ultra Librarian

CAE data

| | | |
|------------------------------|-----|----------|
| ZUKEN Portal 232-150/039-000 | URL | Download |
|------------------------------|-----|----------|

Environmental Product Compliance

Compliance Search

| | | |
|--|-----|----------|
| Environmental Product Compliance 232-150/039-000 THT female header; 0.6 x 1.0 mm solder pin; straight; Locking lever; 2.5 mm ² ; Pin spacing 5 mm; 20-pole; gray | URL | Download |
|--|-----|----------|

Installation Notes

Product family

[*MCS* MIDI Classic](#)
[Show all products from the family](#)

Subject to changes. Please also observe the further product documentation!