

REV.	DESCRIPTION	DRAWN	DATE
1	INITIAL RELEASE	FROS	2025/08/11

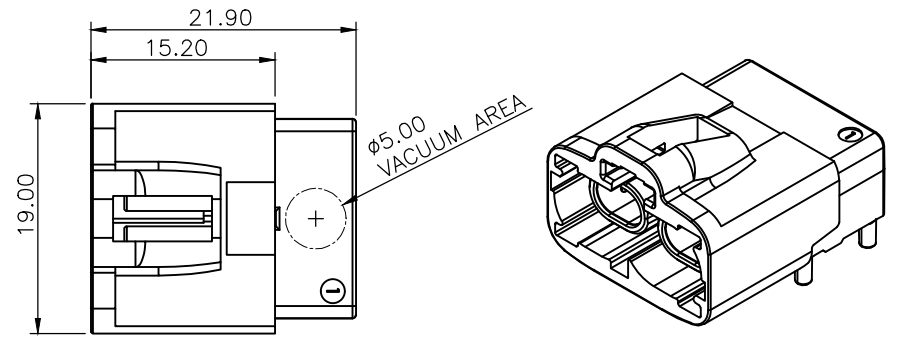

SPECIFICATION:

1. ELECTRICAL
 - 1.1 Impedance: 100Ω
 - 1.2 Frequency: DC 10 GHz
 - 1.3 Insulation Resistance: 100MΩ Min.
 - 1.4 Withstanding Voltage: 250Vrms
 - 1.5 Voltage Rating: 60DC
 - 1.6 Current Rating: 1.5A
 - 1.7 Contact Resistance: 10mΩ Max.
2. MECHANICAL
 - 2.1 Mating Cycles: ≥ 25 cycles
3. ENVIRONMENTAL
 - 3.1 Operating temperature range: -40°C~+105°C
 - 3.2 Storage temperature range: -40°C~+105°C
4. SOLDER ABILITY
 - 4.1 Recommended Wave Soldering Temperature: 260°C

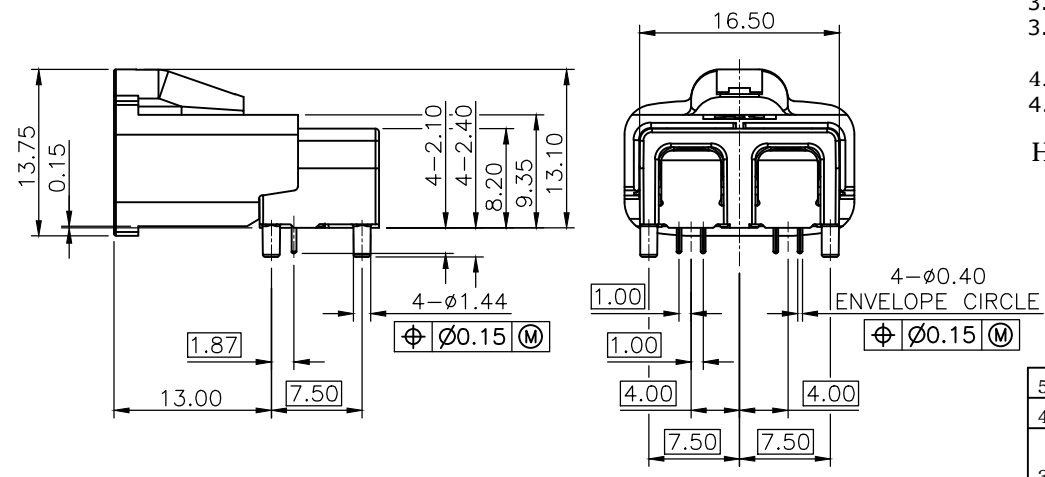
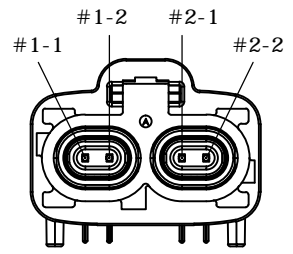

How to order

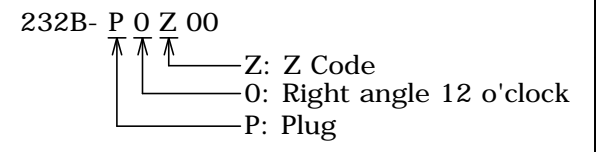



5	GROUND PIN	Copper alloy, tin plating over nickel
4	OUTER CNT	Zinc alloy, tin plating over nickel
		Copper alloy, 6u" gold on contact area, tin plating on solder tails, under plating nickel over all
3	CONTACT	
2	INNER HSG	Thermoplastic, black
1	HOUSING	PA

NO.	PART NAME	DESCRIPTION		
UNLESS OTHERWISE SPECIFIED TOLERANCE				
UNIT:	DECIMAL	LINEAR	ANGLES	
	X.	±0.50	±5°	
	X.X	±0.25	±3°	
	X.XX	±0.12	±1°	
www.attend.com.tw				
DRAWN	Fros	2025/08/11	DRAWN NAME: HS-MTP Plug, 1x2 Port, Right Angle	
CHECKED	Tim	2025/08/11		
APPROVED	Ken	2025/08/11	PRODUCT NO. 232B-POX00	
SCALE 1.6/1		SHEET 1/3	SIZE A4	FILE NAME 232B-POX00_B_1

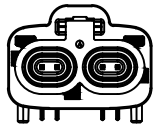
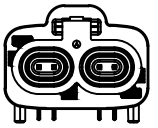
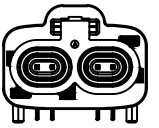
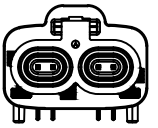
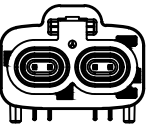
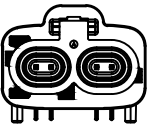
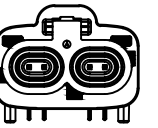
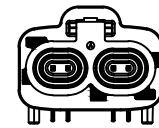
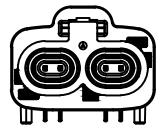
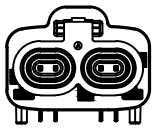
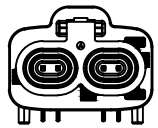
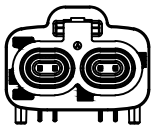
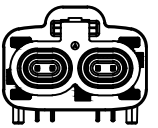
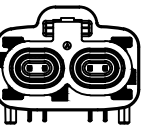

REV.	DESCRIPTION	DRAWN	DATE
------	-------------	-------	------

CODING	A	B	C	D	E	F	G
							
CODING	H	J	K	L	M	O	Z
							

UNLESS OTHERWISE SPECIFIED TOLERANCE				 www.attend.com.tw
UNIT:	DECIMAL	LINEAR	ANGLES	
mm	X.	±0.50	±5°	
	X.X	±0.25	±3°	
	X.XX	±0.12	±1°	
DRAWN	Fros	2025/08/11	DRAWN NAME: HS-MTP Plug, 1x2 Port, Right Angle	
CHECKED	Tim	2025/08/11		
APPROVED	Ken	2025/08/11	PRODUCT NO. 232B-POX00	
	SCALE 1/1	SHEET 3/3	SIZE A4	FILE NAME 232B-POX00_B_1

REV.	DESCRIPTION	DRAWN	DATE
1	INITIAL RELEASE	FROS	2025/08/11

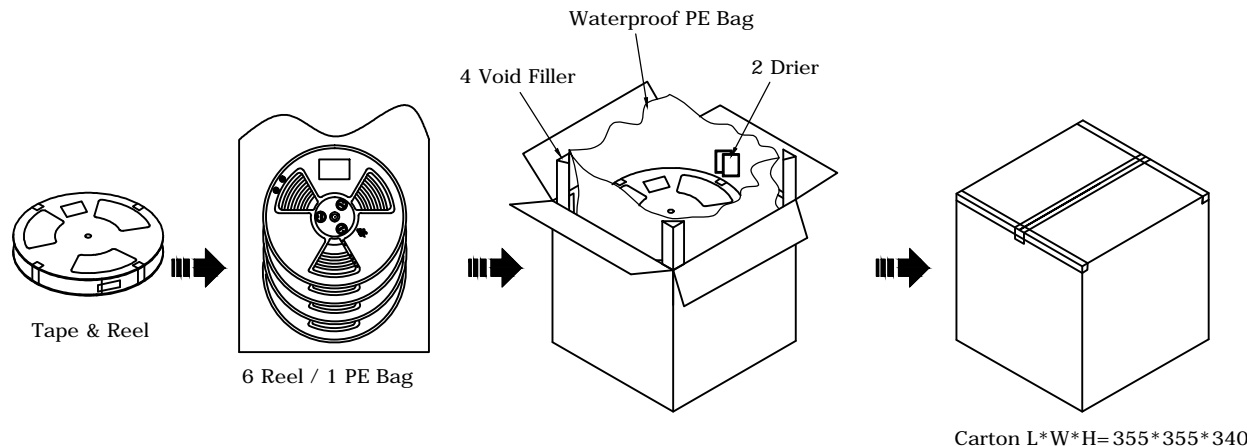
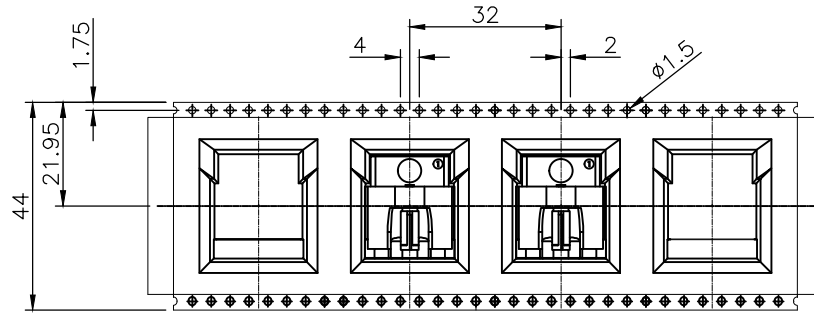
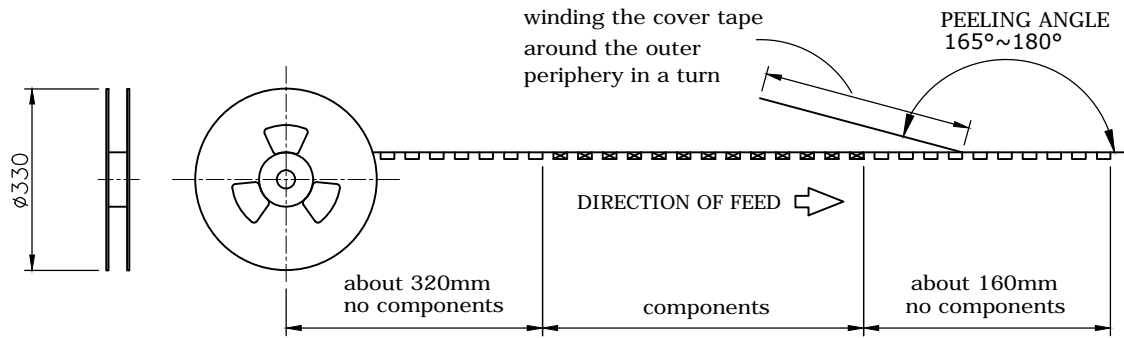

PACKAGING SPECIFICATION:

1. MATERIAL

- 1.1 Embossed Carrier Tape: PS Black
- 1.2 Top Cover Tape: PET
20-80g(Peel Speed 300mm/Minute)
- 1.3 Taping Reel: Plastic

2. PACKING

- 2.1 Quantity:
110 Piece/Reel
6 Reel/Carton
660 Piece/Carton

UNLESS OTHERWISE SPECIFIED TOLERANCE

UNIT:	DECIMAL	LINEAR	ANGLES
mm	X.	±0.50	±5°
	X.X	±0.25	±3°
	X.XX	±0.12	±1°



www.attend.com.tw

DRAWN	Fros	2025/08/11	DRAWN NAME:
CHECKED	Tim	2025/08/11	HS-MTP Plug, 1x2 Port, Right Angle
APPROVED	Ken	2025/08/11	PRODUCT NO. 232B-POX00
SCALE	0.625	SHEET 1/1	SIZE A4
FILE NAME	232B-POX00_D_1		