

Data sheet | Item number: 2200-1201

TOPJOB®S feedthrough terminal block with Push-buttons; rail mount; 2-conductor; 3.5 mm wide; gray

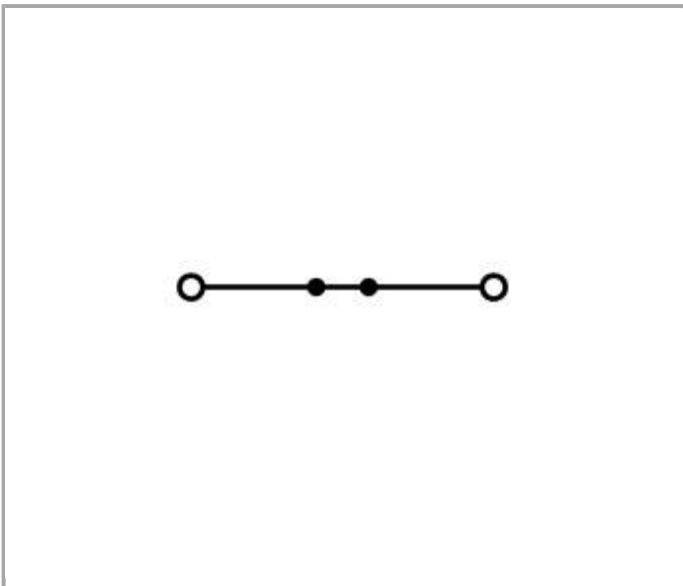

www.wago.com/2200-1201

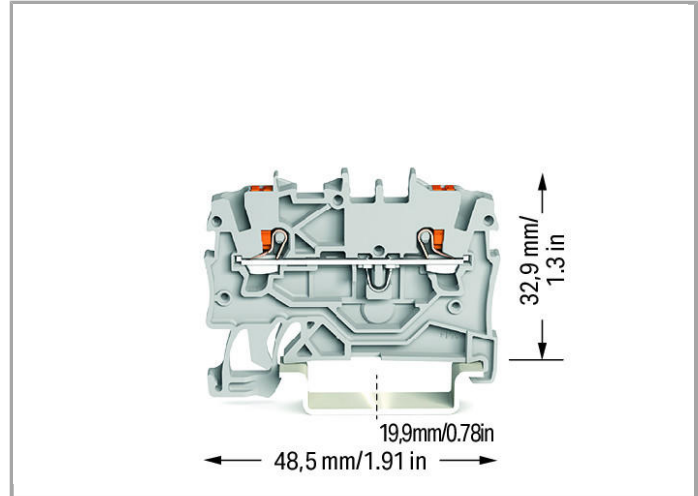
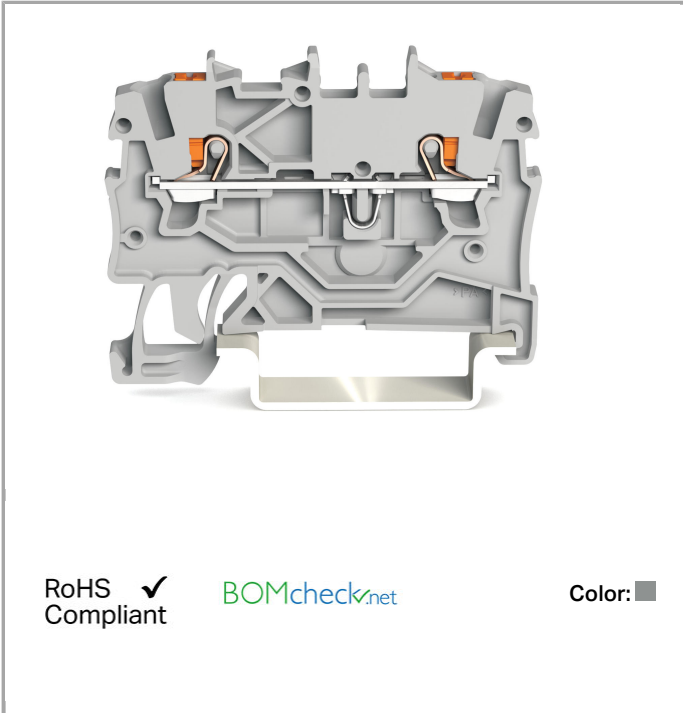

Data
Electrical data

Ratings per IEC/EN 60664-1

Rated voltage (III / 3)	800 V
Rated impulse voltage (III / 3)	8 kV
Rated current	13.5 A
Rated current (2)	18 A
Legend (ratings)	(III / 3) \triangleq Overvoltage category III / Pollution degree 3

Approvals per UL 1059

Rated voltage UL (Use Group B)	600 V
Rated current UL (Use Group B)	10 A
Rated voltage UL (Use Group C)	600 V
Rated current UL (Use Group C)	10 A

Connection data

Connection technology	Push-in CAGE CLAMP [®]
Actuation type	Push-in Push-button Operating tool
Connectable conductor materials	Copper
Nominal cross section	1 mm ²
Solid conductor	0.14 ... 1.5 mm ² / 24 ... 16 AWG
Solid conductor, push-in termination	0.5 ... 1.5 mm ² / 20 ... 16 AWG
Fine-stranded conductor	0.14 ... 1.5 mm ² / 24 ... 16 AWG
Fine-stranded conductor with ferrule, push-in termination, from	0.5 mm ² / 20 AWG
Strip length	9 ... 11 mm / 0.35 ... 0.43 Inch
Number of levels	1
Total number of connection points	2
Total number of potentials	1
Type of wiring	Front-entry wiring

Geometrical Data

Width	3.5 mm / 0.138 inch
Height from upper-edge of DIN-35 rail	32.9 mm / 1.295 inch
Depth	48.5 mm / 1.909 inch

Mechanical data

Design	horizontal
Type of mounting	DIN-35 rail
Marking level	Center/side marking

Material Data

Color	gray
Insulating material	Polyamide 66 (PA 66)
Weight	3.504 g

Commercial data

Packaging type	BOX
Country of origin	DE
GTIN	4055143691543

Approvals / Certificates



Ex-Approvals

Logo	Approval	Certificate name
	AEx Underwriters Laboratories Inc.	4788311594

Country specific Approvals

















Logo	Approval	Certificate name
	CCA DEKRA Certification B.V.	NTR NL 7663
	KEMA/KEUR DEKRA Certification B.V.	71-102874

















UL-Approvals

















Logo	Approval	Certificate name
	cURus Underwriters Laboratories Inc.	4788311592
	UL UL International Netherlands B.V. (ORDINARY LOCATIONS)	E175199 Sec.1 (ORDINARY LOCATIONS)

Compatible products

Jumper

	Item no.: 2000-402 TOPJOB®S jumper; for 2000 series; insulated; 2-way; light-gray	www.wago.com/2000-402
	Item no.: 2000-402/000-005 TOPJOB®S jumper; for 2000 series; insulated; 2-way; red	www.wago.com/2000-402/000-005
	Item no.: 2000-402/000-006 TOPJOB®S jumper; for 2000 series; insulated; 2-way; blue	www.wago.com/2000-402/000-006
	Item no.: 2000-402/000-018 TOPJOB®S jumper; for 2000 series; insulated; 2-way; green-yellow	www.wago.com/2000-402/000-018
	Item no.: 2000-403 TOPJOB®S jumper; for 2000 series; insulated; 3-way; light-gray	www.wago.com/2000-403
	Item no.: 2000-403/000-005 TOPJOB®S jumper; for 2000 series; insulated; 3-way; red	www.wago.com/2000-403/000-005
	Item no.: 2000-403/000-006 TOPJOB®S jumper; for 2000 series; insulated; 3-way; blue	www.wago.com/2000-403/000-006
	Item no.: 2000-404 TOPJOB®S jumper; for 2000 series; insulated; 4-way; light-gray	www.wago.com/2000-404
	Item no.: 2000-404/000-005 TOPJOB®S jumper; for 2000 series; insulated; 4-way; red	www.wago.com/2000-404/000-005
	Item no.: 2000-404/000-006 TOPJOB®S jumper; for 2000 series; insulated; 4-way; blue	www.wago.com/2000-404/000-006
	Item no.: 2000-405 TOPJOB®S jumper; for 2000 series; insulated; 5-way; light-gray	www.wago.com/2000-405
	Item no.: 2000-405/000-005 TOPJOB®S jumper; for 2000 series; insulated; 5-way; red	www.wago.com/2000-405/000-005
	Item no.: 2000-405/000-006 TOPJOB®S jumper; for 2000 series; insulated; 5-way; blue	www.wago.com/2000-405/000-006
	Item no.: 2000-405/011-000 TOPJOB®S jumper; Wye configuration; for 2000 series; insulated; 3-way (1-3-5); light-gray	www.wago.com/2000-405/011-000
	Item no.: 2000-406 TOPJOB®S jumper; for 2000 series; insulated; 6-way; light-gray	www.wago.com/2000-406
	Item no.: 2000-406/000-005 TOPJOB®S jumper; for 2000 series; insulated; 6-way; red	www.wago.com/2000-406/000-005

	Item no.: 2000-406/000-006 TOPJOB®S jumper; for 2000 series; insulated; 6-way; blue	www.wago.com/2000-406/000-006
	Item no.: 2000-406/020-000 TOPJOB®S jumper; Delta configuration; for 2000 series; insulated; 6-way (1-2, 3-4, 5-6); light-gray	www.wago.com/2000-406/020-000
	Item no.: 2000-407 TOPJOB®S jumper; for 2000 series; insulated; 7-way; light-gray	www.wago.com/2000-407
	Item no.: 2000-407/000-005 TOPJOB®S jumper; for 2000 series; insulated; 7-way; red	www.wago.com/2000-407/000-005
	Item no.: 2000-407/000-006 TOPJOB®S jumper; for 2000 series; insulated; 7-way; blue	www.wago.com/2000-407/000-006
	Item no.: 2000-408 TOPJOB®S jumper; for 2000 series; insulated; 8-way; light-gray	www.wago.com/2000-408
	Item no.: 2000-408/000-005 TOPJOB®S jumper; for 2000 series; insulated; 8-way; red	www.wago.com/2000-408/000-005
	Item no.: 2000-408/000-006 TOPJOB®S jumper; for 2000 series; insulated; 8-way; blue	www.wago.com/2000-408/000-006
	Item no.: 2000-409 TOPJOB®S jumper; for 2000 series; insulated; 9-way; light-gray	www.wago.com/2000-409
	Item no.: 2000-409/000-005 TOPJOB®S jumper; for 2000 series; insulated; 9-way; red	www.wago.com/2000-409/000-005
	Item no.: 2000-409/000-006 TOPJOB®S jumper; for 2000 series; insulated; 9-way; blue	www.wago.com/2000-409/000-006
	Item no.: 2000-410 TOPJOB®S jumper; for 2000 series; insulated; 10-way; light-gray	www.wago.com/2000-410
	Item no.: 2000-410/000-005 TOPJOB®S jumper; for 2000 series; insulated; 10-way; red	www.wago.com/2000-410/000-005
	Item no.: 2000-410/000-006 TOPJOB®S jumper; for 2000 series; insulated; 10-way; blue	www.wago.com/2000-410/000-006
	Item no.: 2000-433 TOPJOB®S jumper; for 2000 series; insulated; 2-way (1-3); light-gray	www.wago.com/2000-433
	Item no.: 2000-433/000-005 TOPJOB®S jumper; for 2000 series; insulated; 2-way (1-3); red	www.wago.com/2000-433/000-005

	<p>Item no.: 2000-433/000-006 TOPJOB®S jumper; for 2000 series; insulated; 2-way (1-3); blue</p>	www.wago.com/2000-433/000-006
	<p>Item no.: 2000-434 TOPJOB®S jumper; for 2000 series; insulated; 2-way (1-4); light-gray</p>	www.wago.com/2000-434
	<p>Item no.: 2000-435 TOPJOB®S jumper; for 2000 series; insulated; 2-way (1-5); light-gray</p>	www.wago.com/2000-435
	<p>Item no.: 2000-436 TOPJOB®S jumper; for 2000 series; insulated; 2-way (1-6); light-gray</p>	www.wago.com/2000-436
	<p>Item no.: 2000-437 TOPJOB®S jumper; for 2000 series; insulated; 2-way (1-7); light-gray</p>	www.wago.com/2000-437
	<p>Item no.: 2000-438 TOPJOB®S jumper; for 2000 series; insulated; 2-way (1-8); light-gray</p>	www.wago.com/2000-438
	<p>Item no.: 2000-439 TOPJOB®S jumper; for 2000 series; insulated; 2-way (1-9); light-gray</p>	www.wago.com/2000-439
	<p>Item no.: 2000-440 TOPJOB®S jumper; for 2000 series; insulated; 2-way (1-10); light-gray</p>	www.wago.com/2000-440
	<p>Item no.: 2009-402 TOPJOB®S wire jumper; insulated; 60 mm long; conductor cross section 0.75 mm²; suitable for 2000 and 2020 series terminal blocks; gray</p>	www.wago.com/2009-402
	<p>Item no.: 2009-404 TOPJOB®S wire jumper; insulated; 110 mm long; conductor cross section 0.75 mm²; suitable for 2000 and 2020 series terminal blocks; gray</p>	www.wago.com/2009-404
	<p>Item no.: 2009-406 TOPJOB®S wire jumper; insulated; 250 mm long; conductor cross section 0.75 mm²; suitable for 2000 and 2020 series terminal blocks; gray</p>	www.wago.com/2009-406
	<p>Item no.: 210-103 Wire commoning chain; insulated; 50 connections</p>	www.wago.com/210-103
	<p>Item no.: 210-123 Wire commoning chain; insulated; 50 connections</p>	www.wago.com/210-123
tools		
	<p>Item no.: 210-647 Operating tool with partially insulated shaft; Blade (2.5 x 0.4) mm; short</p>	www.wago.com/210-647
	<p>Item no.: 210-648 Operating tool with partially insulated shaft; Blade (2.5 x 0.4) mm; short; angled</p>	www.wago.com/210-648
	<p>Item no.: 210-719 Operating tool with partially insulated shaft; Type 1, blade (2.5 x 0.4) mm</p>	www.wago.com/210-719
End plate		
	<p>Item no.: 2000-1291 TOPJOB®S end/intermediate plate; for 2000-12xx series terminal blocks; 0.7 mm wide; gray</p>	www.wago.com/2000-1291



Item no.: 2000-1292

TOPJOB®S end/intermediate plate; for 2000-12xx series terminal blocks; 0.7 mm wide; orange

www.wago.com/2000-1292

Carrier rail



Item no.: 210-112

Steel carrier rail; 35 x 7.5 mm; 1 mm thick; 2 m long; slotted; according to EN 60715; "Hole width 25 mm

www.wago.com/210-112

Item no.: 210-113

Steel carrier rail; 35 x 7.5 mm; 1 mm thick; 2 m long; unslotted; according to EN 60715

www.wago.com/210-113

Item no.: 210-114

Steel carrier rail; 35 x 15 mm; 1.5 mm thick; 2 m long; unslotted; similar to EN 60715

www.wago.com/210-114

Item no.: 210-115

Steel carrier rail; 35 x 7.5 mm; 1 mm thick; 2 m long; slotted; according to EN 60715; "Hole width 18 mm

www.wago.com/210-115

Item no.: 210-118

Steel carrier rail; 35 x 15 mm; 2.3 mm thick; 2 m long; unslotted; according to EN 60715

www.wago.com/210-118

Item no.: 210-196

Aluminum carrier rail; 35 x 8.2 mm; 1.6 mm thick; 2 m long; unslotted; similar to EN 60715

www.wago.com/210-196

Item no.: 210-197

Steel carrier rail; 35 x 15 mm; 1.5 mm thick; 2 m long; slotted; similar to EN 60715

www.wago.com/210-197

Item no.: 210-198

Copper carrier rail; 35 x 15 mm; 2.3 mm thick; 2 m long; unslotted; according to EN 60715

www.wago.com/210-198

Marking accessories



Item no.: 2009-110

Marking strips; on reel; not stretchable; plain; snap-on type

www.wago.com/2009-110

Item no.: 2009-113

WMB-Inline; for smartPRINTER; on reel; plain; snap-on type

www.wago.com/2009-113

Item no.: 2009-113/000-002

WMB-Inline; on reel; plain; snap-on type

www.wago.com/2009-113/000-002

Item no.: 2009-113/000-005

WMB-Inline; on reel; plain; snap-on type

www.wago.com/2009-113/000-005

Item no.: 2009-113/000-006

WMB-Inline; on reel; plain; snap-on type

www.wago.com/2009-113/000-006

Item no.: 2009-113/000-007



















WMB-Inline; on reel; plain; snap-on type

www.wago.com/2009-113/000-007

Item no.: 2009-113/000-012

WMB-Inline; on reel; plain; snap-on type

www.wago.com/2009-113/000-012

	Item no.: 2009-113/000-017 WMB-Inline; on reel; plain; snap-on type	www.wago.com/2009-113/000-017
	Item no.: 2009-113/000-023 WMB-Inline; on reel; plain; snap-on type	www.wago.com/2009-113/000-023
	Item no.: 2009-113/000-024 WMB-Inline; on reel; plain; snap-on type	www.wago.com/2009-113/000-024
	Item no.: 793-3501 WMB marking card; as card; plain; snap-on type	www.wago.com/793-3501
check		
	Item no.: 2000-510 TOPJOB®S modular connector; for 2000 series; for jumper contact slot; 1-pole; gray	www.wago.com/2000-510
	Item no.: 2000-511 TOPJOB®S modular connector; for 2000 series; with gray separator plate; for jumper contact slot; 1-pole; gray	www.wago.com/2000-511
	Item no.: 2000-549 TOPJOB®S spacer module; for 2000-511; 5.2 mm wide; gray	www.wago.com/2000-549
	Item no.: 2000-552 TOPJOB®S connector strip; for 2000 series; for jumper contact slot; 2-pole; gray	www.wago.com/2000-552
	Item no.: 2000-553 TOPJOB®S connector strip; for 2000 series; for jumper contact slot; 3-pole; gray	www.wago.com/2000-553
	Item no.: 2000-554 TOPJOB®S connector strip; for 2000 series; for jumper contact slot; 4-pole; gray	www.wago.com/2000-554
	Item no.: 2000-555 TOPJOB®S connector strip; for 2000 series; for jumper contact slot; 5-pole; gray	www.wago.com/2000-555
	Item no.: 2000-556 TOPJOB®S connector strip; for 2000 series; for jumper contact slot; 6-pole; gray	www.wago.com/2000-556
	Item no.: 2000-557 TOPJOB®S connector strip; for 2000 series; for jumper contact slot; 7-pole; gray	www.wago.com/2000-557
	Item no.: 2000-558 TOPJOB®S connector strip; for 2000 series; for jumper contact slot; 8-pole; gray	www.wago.com/2000-558
	Item no.: 2000-559 TOPJOB®S connector strip; for 2000 series; for jumper contact slot; 9-pole; gray	www.wago.com/2000-559
	Item no.: 2000-560 TOPJOB®S connector strip; for 2000 series; for jumper contact slot; 10-pole; gray	www.wago.com/2000-560
	Item no.: 2009-174 TOPJOB®S test plug adapter; for test plug 4 mm Ø; for testing TOPJOB®S terminal blocks; gray	www.wago.com/2009-174
	Item no.: 2009-182 TOPJOB®S testing tap; tool-free; 12 AWG max; for testing TOPJOB®S terminal blocks; gray	www.wago.com/2009-182



Item no.: 210-136
Test plug; 2 mm Ø; with 500 mm cable

www.wago.com/210-136



Item no.: 210-137
Test plug; 2.3 mm Ø; with 500 mm cable

www.wago.com/210-137

ferrule



Item no.: 216-241
Ferrule; Sleeve for 0.5 mm² / AWG 22; insulated; electro-tin plated; electrolytic copper; gastight crimped; acc. to DIN 46228, Part 4/09.90 www.wago.com/216-241



Item no.: 216-242
Ferrule; Sleeve for 0.75 mm² / AWG 20; insulated; electro-tin plated; electrolytic copper; gastight crimped; acc. to DIN 46228, Part 4/09.90 www.wago.com/216-242



Item no.: 216-243
Ferrule; Sleeve for 1 mm² / AWG 18; insulated; electro-tin plated; electrolytic copper; gastight crimped; acc. to DIN 46228, Part 4/09.90 www.wago.com/216-243

Downloads

Documentation

Bid Text

2200-1201	15.8.2018	DOCX 14.9 kB	Download
-----------	-----------	-----------------	----------

CAD files

CAD data

3D Download 2200-1201	Download
-----------------------	----------

Subject to changes.