



ATTENTION
OBSERVE PRECAUTIONS
FOR HANDLING
ELECTROSTATIC
DISCHARGE
SENSITIVE
DEVICES

Part Number: L-154A4SUREQBFZGW

Hyper Red
Blue
Green

Features

- Uniform light output.
- Low power consumption.
- Long life-solid state reliability.
- RoHS compliant.

Description

The Hyper Red source color devices are made with Al-GaN on GaAs substrate Light Emitting Diode.

The Blue source color devices are made with InGaN Light Emitting Diode.

The Green source color devices are made with InGaN on Sapphire Light Emitting Diode.

Static electricity and surge damage the LEDs.

It is recommended to use a wrist band or anti-electrostatic glove when handling the LEDs.

All devices, equipment and machinery must be electrically grounded.

Package Dimensions

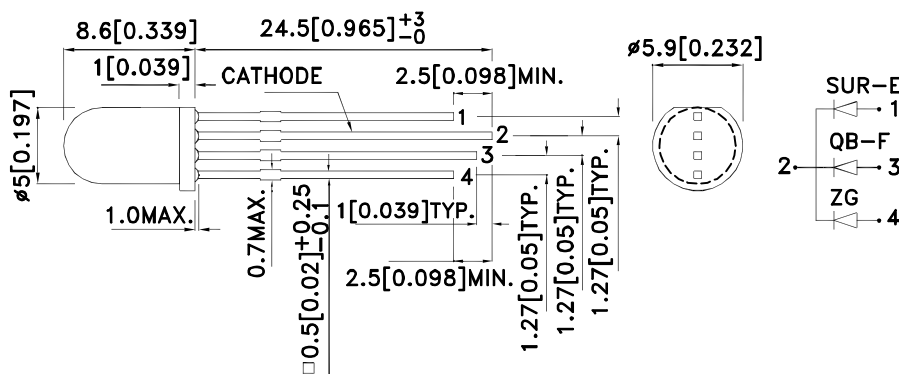

Notes:

1. All dimensions are in millimeters (inches).
2. Tolerance is $\pm 0.25(0.01)$ unless otherwise noted.
3. Lead spacing is measured where the leads emerge from the package.
4. The specifications, characteristics and technical data described in the datasheet are subject to change without prior notice.



Selection Guide

Part No.	Dice	Lens Type	Iv (mcd) [2] @ 20mA		Viewing Angle [1]
			Min.	Typ.	2θ1/2
L-154A4SUREQBFGW	Hyper Red (AlGaInP)	White Diffused	400	1000	60°
			*120	*250	
	Blue (InGaN)		300	500	
			*300	*500	
	Green (InGaN)		600	1300	
			*600	*1300	

Notes:

1. θ1/2 is the angle from optical centerline where the luminous intensity is 1/2 of the optical peak value.
 2. Luminous intensity/ luminous Flux: +/-15%.
- *Luminous intensity value is traceable to the CIE127-2007 compliant national standards.

Electrical / Optical Characteristics at TA=25°C

Symbol	Parameter	Device	Typ.		Max.	Units	Test Conditions
λpeak	Peak Wavelength	Hyper Red Blue Green	640 461 515	*645 *460 *515		nm	If=20mA
λD [1]	Dominant Wavelength	Hyper Red Blue Green	630 465 525	*630 *465 *525		nm	If=20mA
Δλ1/2	Spectral Line Half-width	Hyper Red Blue Green	25 25 30			nm	If=20mA
C	Capacitance	Hyper Red Blue Green	45 100 45			pF	Vf=0V;f=1MHz
Vf [2]	Forward Voltage	Hyper Red Blue Green	1.9 3.3 3.3		2.5 4 4.1	V	If=20mA
IR	Reverse Current	Hyper Red Blue Green			10 50 50	uA	Vr=5V

Notes:

1. Wavelength: +/-1nm.
 2. Forward Voltage: +/-0.1V.
- *Wavelength value is traceable to the CIE127-2007 compliant national standards.

Absolute Maximum Ratings at TA=25°C

Parameter	Hyper Red	Blue	Green	Units
Power dissipation	75	120	102.5	mW
DC Forward Current	30	30	25	mA
Peak Forward Current [1]	200	150	150	mA
Reverse Voltage	5			V
Operating/Storage Temperature	-40°C To +85°C			
Lead Solder Temperature [2]	260°C For 3 Seconds			
Lead Solder Temperature [3]	260°C For 5 Seconds			

Notes:

1. 1/10 Duty Cycle, 0.1ms Pulse Width.
2. 2mm below package base.
3. 5mm below package base.

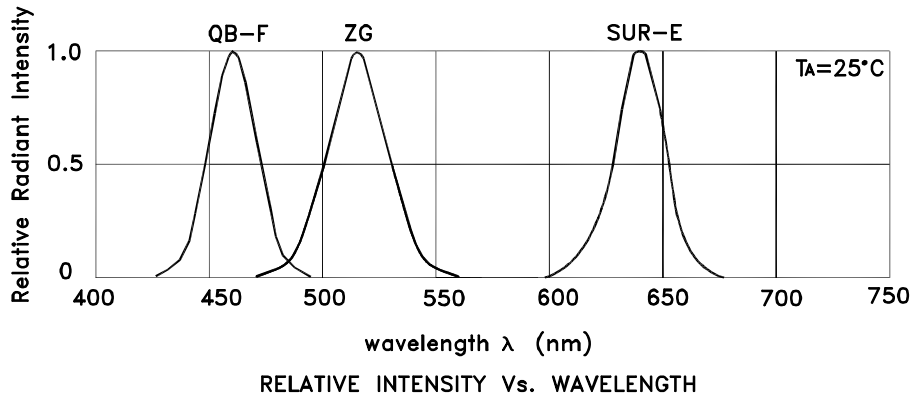

L-154A4SUREQBFZGW Hyper Red

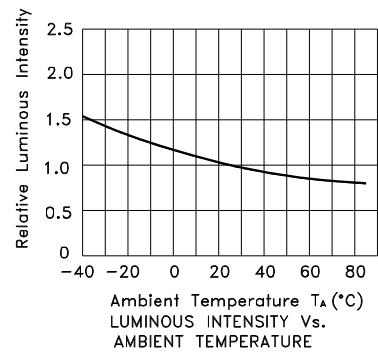
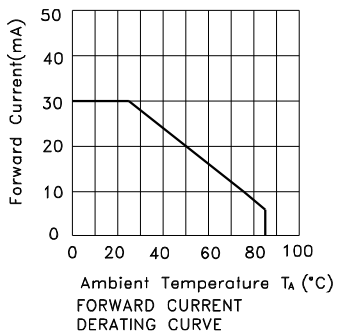
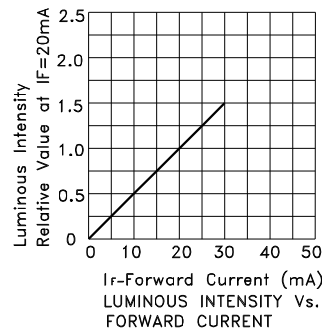
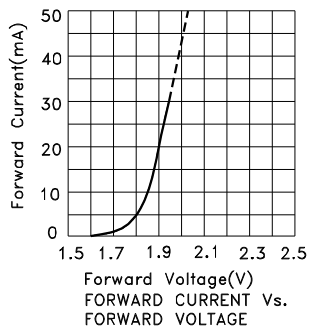

Kingbright

Blue

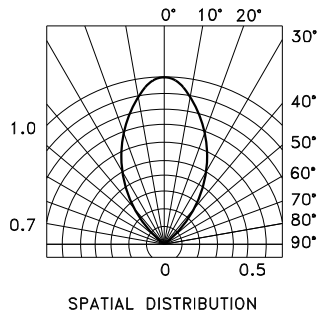
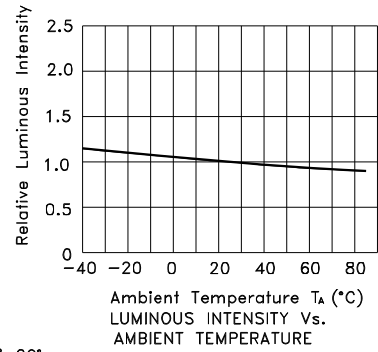
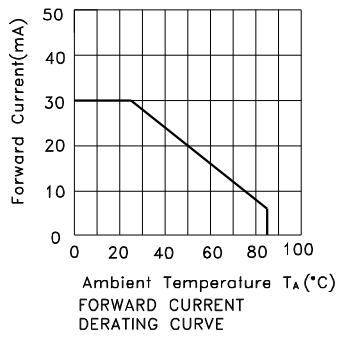
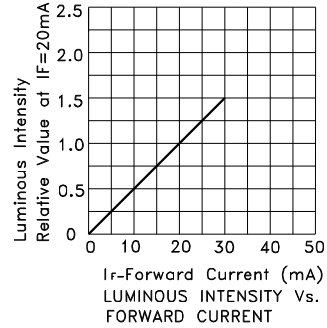
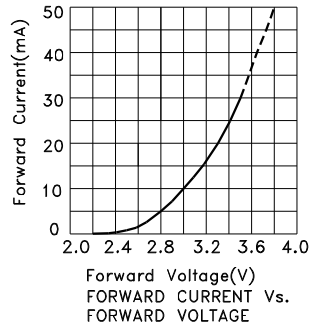

Green

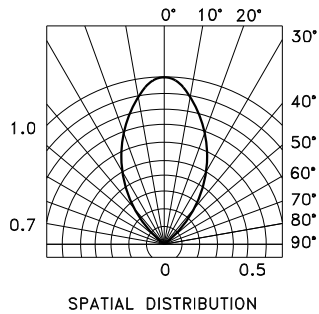
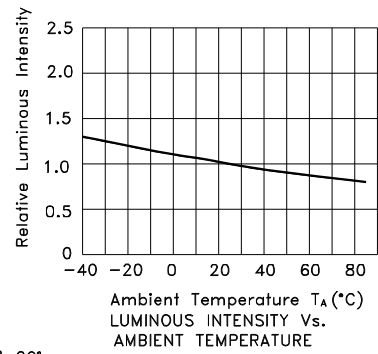
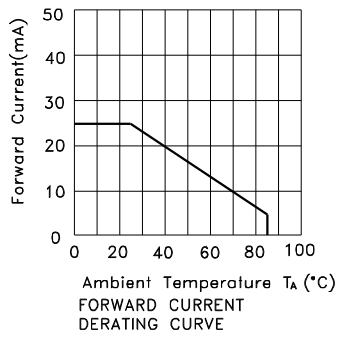
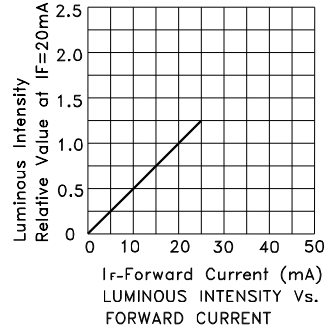
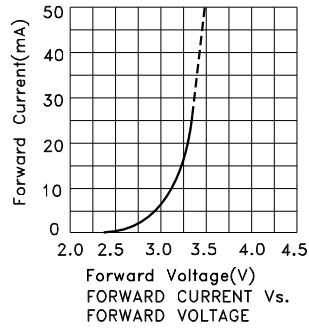

PACKING & LABEL SPECIFICATIONS

L-154A4SUREQBFZGW

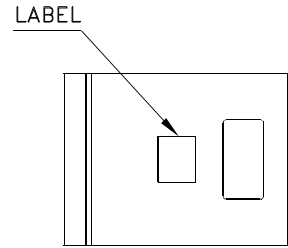
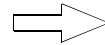
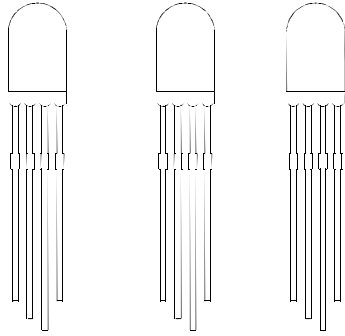

500PCS / BAG



20K / 9# BOX

OUTSIDE LABEL

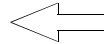

OUTSIDE LABEL

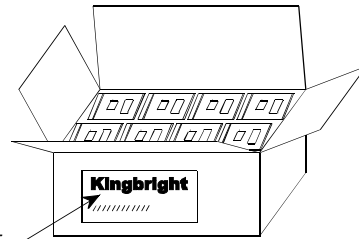

10K / 5# BOX

<h1>Kingbright</h1>	
P/NO: L-154A4xxx	
QTY: 500 pcs	Q.C. Q C XX XX XXXX PASSED
S/N: XXXX	
CODE: XXX	
LOT NO:	
 xxxxxxxxxxxxxxxxxxxxxxxx	
RoHS Compliant	

PRECAUTIONS

1. The lead pitch of the LED must match the pitch of the mounting holes on the PCB during component placement. Lead-forming may be required to insure the lead pitch matches the hole pitch. Refer to the figure below for proper lead forming procedures. (Fig. 1)

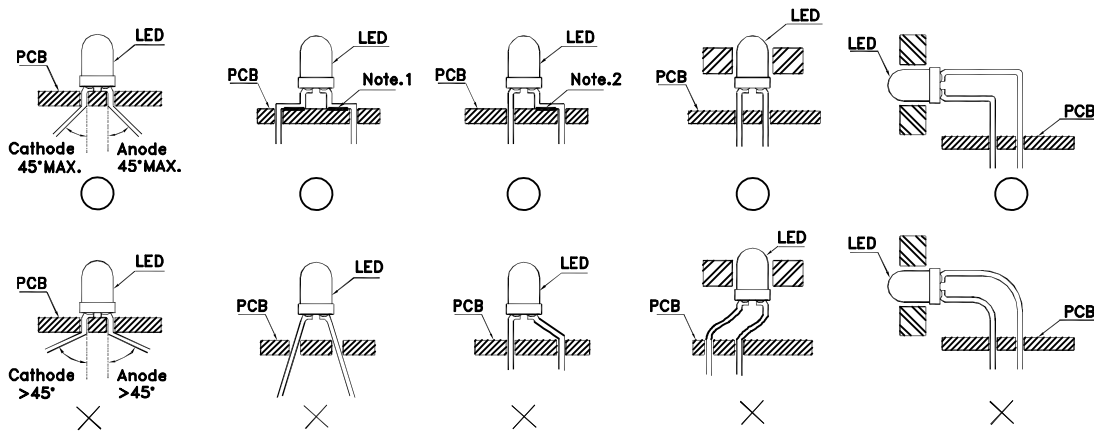

Fig.1

”○” Correct mounting method ”×” Incorrect mounting method

2. When soldering wire to the LED, use individual heat-shrink tubing to insulate the exposed leads to prevent accidental contact short-circuit. (Fig.2)
3. Use stand-offs (Fig.3) or spacers (Fig.4) to securely position the LED above the PCB.

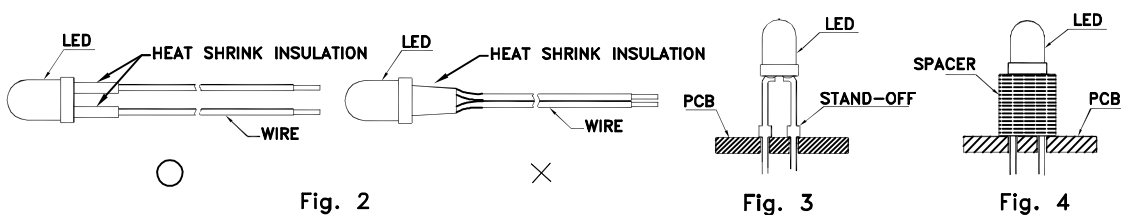

Fig. 2

Fig. 3

Fig. 4

4. Maintain a minimum of 2mm clearance between the base of the LED lens and the first lead bend. (Fig. 5 and 6)
5. During lead forming, use tools or jigs to hold the leads securely so that the bending force will not be transmitted to the LED lens and its internal structures. Do not perform lead forming once the component has been mounted onto the PCB. (Fig. 7)

6. Do not bend the leads more than twice. (Fig. 8)

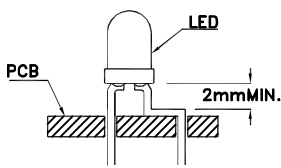

Fig. 5

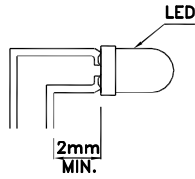

Fig. 6

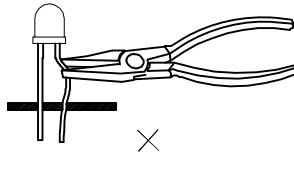

Fig. 7

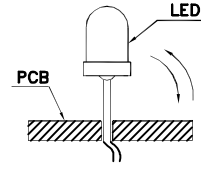
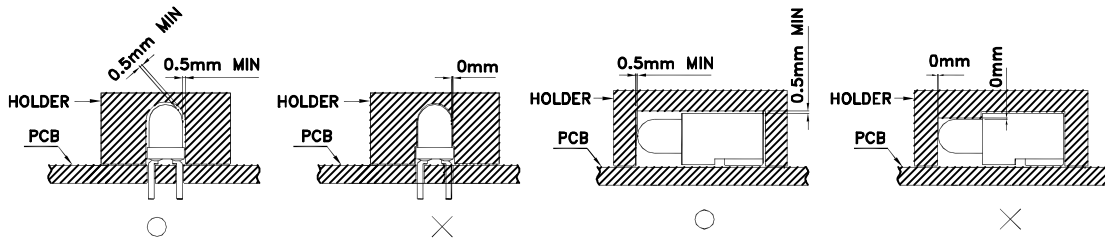

Fig. 8

7. During soldering, component covers and holders should leave clearance to avoid placing damaging stress on the LED during soldering.



8. The tip of the soldering iron should never touch the lens epoxy.

9. Through-hole LEDs are incompatible with reflow soldering.

10. If the LED will undergo multiple soldering passes or face other processes where the part may be subjected to intense heat, please check with Kingbright for compatibility.

11. Recommended Wave Soldering Profiles:

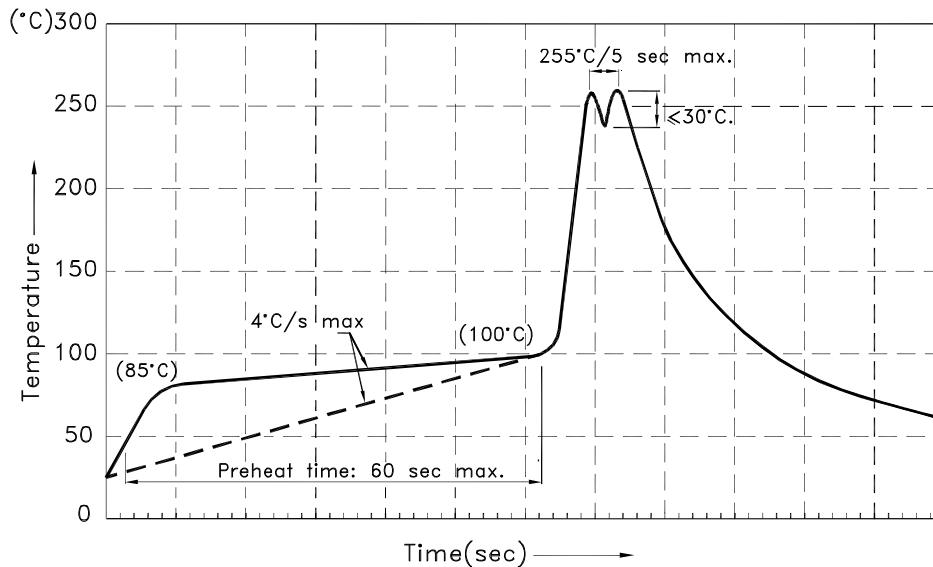

Notes:

1. Recommend pre-heat temperature of 105°C or less (as measured with a thermocouple attached to the LED pins) prior to immersion in the solder wave with a maximum solder bath temperature of 260°C
2. Peak wave soldering temperature between 245°C ~ 255°C for 3 sec (5 sec max).
3. Do not apply stress to the epoxy resin while the temperature is above 85°C.
4. Fixtures should not incur stress on the component when mounting and during soldering process.
5. SAC 305 solder alloy is recommended.
6. No more than one wave soldering pass.

Detailed application notes are listed on our website.

http://www.kingbright.com/application_notes