

Data sheet | Item number: 2092-3373/200-000

1-conductor female plug; push-button; 2.5 mm²; Pin spacing 7.5 mm; 3-pole;
2,50 mm²; light gray



www.wago.com/2092-3373/200-000



 Picture differs from the item.

RoHS  Compliant



Color: 

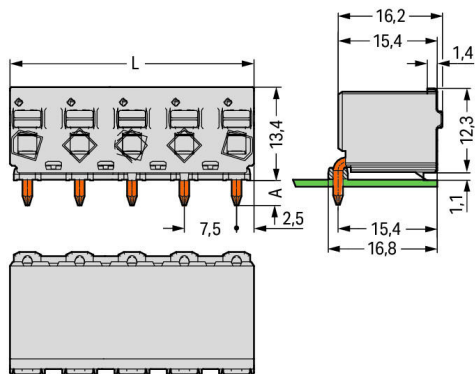
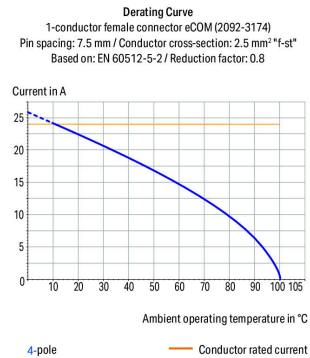

$L = (\text{pole no.} - 1) \times \text{pin spacing} + 5 \text{ mm}$

A = 3.6 mm THT solder pin

A = 2.4 mm THR solder pin

Item description

Subject to changes. Please also observe the further product documentation!

WAGO Kontakttechnik GmbH & Co. KG
Hansastr. 27
32423 Minden
Phone: +49571 887-0 | Fax: +49571 887-169
Email: info.de@wago.com | Web: www.wago.com

Do you have any questions about our products?
We are always happy to take your call at +49 (571) 887-44222.



- Universal connection for all conductor types
- Simple, push-in termination of solid and ferruled conductors
- Easy-to-use design does not require specialty tools
- Ability to wire while mated or unmated
- Integrated test ports for testing parallel to conductor entry
- Factory-installed, straight or angled solder pins allow horizontal or vertical mounting to the PCB

Safety information 1:

The **picoMAX[®] Pluggable Connection System** includes connectors without breaking capacity in accordance with DIN EN 61984. When used as intended, these connectors must not be connected/disconnected when live or under load. The circuit design should ensure header pins, which can be touched, are not live when unmated.

Data

Electrical data

Ratings per IEC/EN

Ratings per	IEC/EN 60664-1
Nominal voltage (III/3)	400 V
Rated surge voltage (III/3)	6 kV
Rated voltage (III/2)	320 V
Rated surge voltage (III/2)	4 kV
Nominal voltage (II/2)	630 V
Rated surge voltage (II/2)	4 kV
Rated current	16 A
Legend (ratings)	(III / 2) ≙ Overvoltage category III / Pollution degree 2

Ratings per UL

Approvals per	UL 1059
Rated voltage UL (Use Group B)	300 V
Rated current UL (Use Group B)	15 A
Rated voltage UL (Use Group D)	300 V
Rated current UL (Use Group D)	10 A

Ratings per CSA

Approvals per	CSA
---------------	-----

Subject to changes. Please also observe the further product documentation!

Connection data

Connection technology	Push-in CAGE CLAMP®
Actuation type	Push-button
Solid conductor	0.2 ... 2.5 mm ² / 24 ... 12 AWG
Fine-stranded conductor	0.2 ... 2.5 mm ² / 24 ... 12 AWG
Fine-stranded conductor; with insulated ferrule	0.25 ... 1.5 mm ²
Fine-stranded conductor; with uninsulated ferrule	0.25 ... 2.5 mm ²
Strip length	9 ... 10 mm / 0.35 ... 0.39 inch
Conductor connection direction to PCB	0°
Pole No.	3
Total number of connection points	3
Total number of potentials	3
Number of connection types	1
Number of levels	1

Physical data

Pin spacing	7.5 mm / 0.295 inch
Width	20 mm / 0.787 inch
Height	13.4 mm / 0.528 inch
Depth	16.2 mm / 0.638 inch
Solder pin length	2.4 mm
Solder pin diameter	1.4 mm
Plated through-hole diameter (THR)	1.6 ^(+0.1) mm

Plug-in connection

Contact type (pluggable connector)	Female connector/socket
Connector (connection type)	for PCB
Mismating protection	No
Mating direction to the PCB	0°

PCB contact

PCB Contact	THR
-------------	-----

Subject to changes. Please also observe the further product documentation!

Material data

Color	light gray
Material group	I
Insulation material	Polyphthalamide (PPA GF)
Flammability class per UL94	V0
Clamping spring material	Chrome nickel spring steel (CrNi)
Contact material	Electrolytic copper (E _{Cu})
Contact plating	tin-plated
Fire load	0.007 MJ
Weight	4.3 g

Environmental requirements



Limit temperature range	-60 ... +100 °C
-------------------------	-----------------

Commercial data

Packaging type	BOX
Country of origin	DE
GTIN	4055143910613
Customs tariff number	85366990990

Approvals / Certificates

Country specific Approvals

Logo	Approval	Additional Approval Text	Certificate name
	CSA DEKRA Certification B.V.	C22.2	2362521
	KEMA/KEUR DEKRA Certification B.V.	EN 61984	71- 102261 REV.1

UL-Approvals

Logo	Approval	Additional Approval Text	Certificate name
	UL	UL 1977	20190909-

Subject to changes. Please also observe the further product documentation!



Downloads

Documentation

Additional Information

Technical explanations	3. 4. 2019	pdf 2.0 MB	Download
THR Soldering Process		pdf 402.7 kB	Download

CAD/CAE-Data

CAD data

2D/3D Models 2092-3373/200-000	URL	Download
--------------------------------	-----	----------

CAE data

ZUKEN Portal 2092-3373/200-000	URL	Download
--------------------------------	-----	----------

Environmental Product Compliance

Compliance Search

Environmental Product Compliance 2092-3373/200-000 1-conductor female plug; push-button; 2.5 mm ² ; Pin spacing 7.5 mm; 3-pole; 2,50 mm ² ; light gray	URL	Download
---	-----	----------

Installation Notes

Conductor termination

Subject to changes. Please also observe the further product documentation!

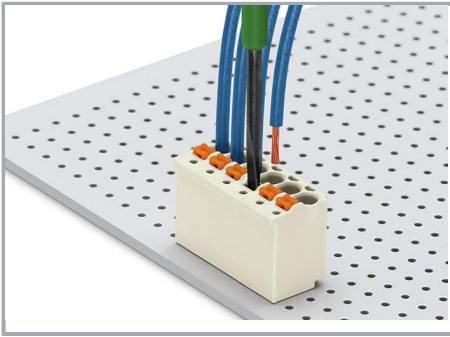

Terminating fine-stranded conductors and removing all conductor types via push-buttons.

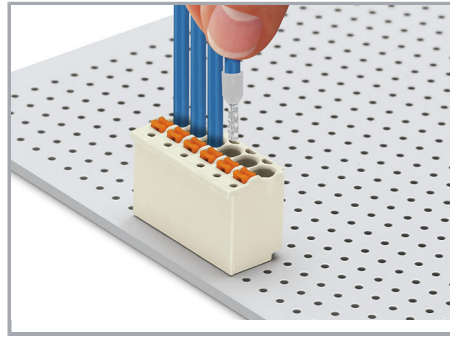

Solid and ferruled conductors are terminated by simply pushing them into unit.

Marking



Pole marking via direct marking perpendicular to conductor entry.



Pole marking via factory direct marking.

Testing

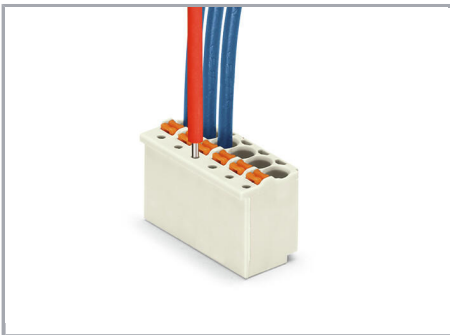

Testing via 1 mm Ø test pin – touch contact.

Product family

<i>picoMAX</i>[®] <i>eCOM</i> 7.5

[Show all products from the family](#)

Subject to changes. Please also observe the further product documentation!