

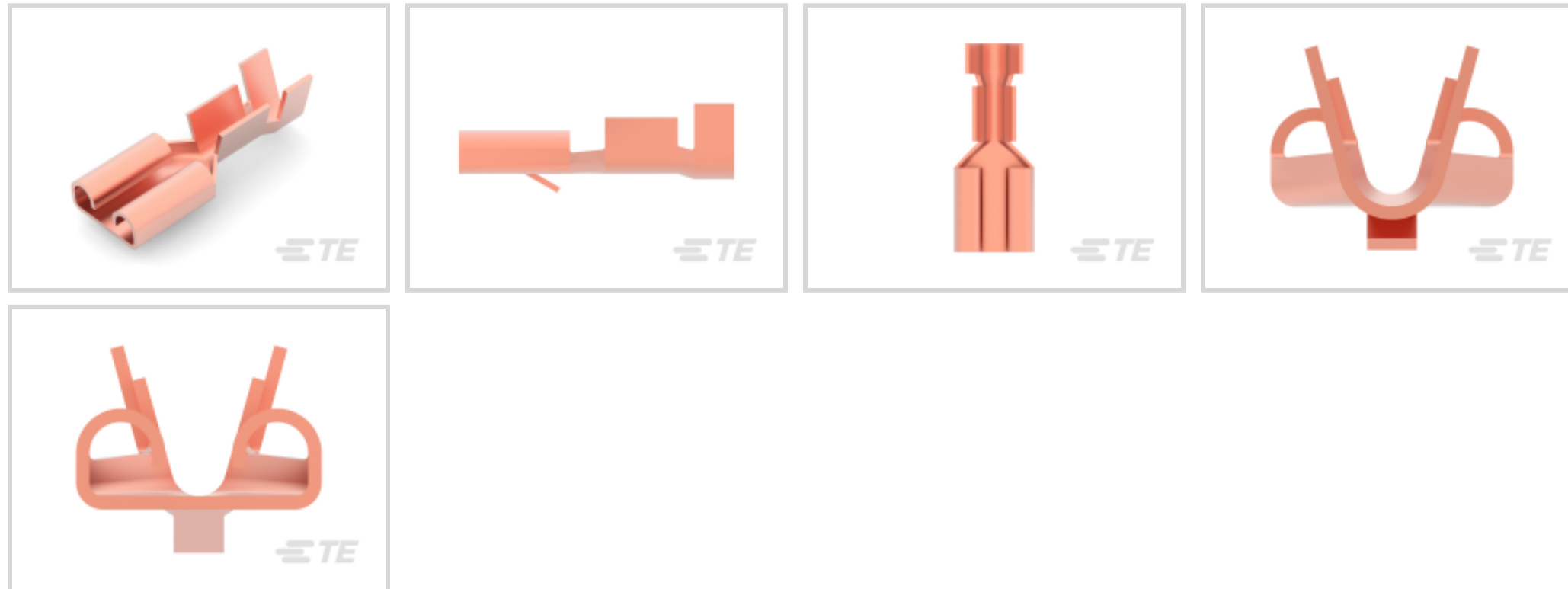

Terminals & Splices > Quick Disconnects



Quick Disconnect Terminal Type: **Receptacle**

Wire Size: 1.03 – 2.62 mm²

Mating Tab Width: 6.35 mm [.25 in]

Mating Tab Thickness: .81 mm [.032 in]

Features

Product Type Features

Insertion Force	Normal
-----------------	--------

Configuration Features

Compatible With Wire & Cable Type	Discrete Wire
Connection Capacity	Single

Contact Features

Quick Disconnect Terminal Type	Receptacle
Mating Tab Width	6.35 mm [.25 in]
Mating Tab Thickness	.81 mm [.032 in]
Terminal Orientation	Straight
Contact Base Material	Phosphor Bronze
Terminal Plating Material	Unplated
Crimp Type	F-Crimp
Barrel Type	Open

Termination Features

--	--



Product Terminates To	Wire & Cable
-----------------------	--------------

Mechanical Attachment

	.046 in
--	---------

Wire Insulation Support	With
-------------------------	------

Mating Retention Type	Locking Lance
-----------------------	---------------

Dimensions

Product Length	19.2 mm [.755 in]
----------------	-------------------

Compatible Insulation Diameter Range	2.11 – 3.1 mm [.083 – .122 in]
--------------------------------------	--------------------------------

Terminal Material Thickness	.41 mm [.016 in]
-----------------------------	------------------

Wire Size	1.03 – 2.62 mm ²
-----------	-----------------------------

Usage Conditions

Insulation Option	Uninsulated
-------------------	-------------

Operating Temperature Range	-40 – 110 °C [-40 – 230 °F]
-----------------------------	-----------------------------

Packaging Features

Packaging Quantity	5000
--------------------	------

Packaging Method	Strip/Reel
------------------	------------

Product Compliance

[For compliance documentation, visit the product page on TE.com>](#)

EU RoHS Directive 2011/65/EU	Compliant
------------------------------	-----------

EU ELV Directive 2000/53/EC	Compliant
-----------------------------	-----------

China RoHS 2 Directive MIIT Order No 32, 2016	No Restricted Materials Above Threshold
---	---

EU REACH Regulation (EC) No. 1907/2006	Current ECHA Candidate List: JUNE 2024 (241) Candidate List Declared Against: JUNE 2024 (241) Does not contain REACH SVHC
--	---

Halogen Content	Low Halogen - Br, Cl, F, I < 900 ppm per homogenous material. Also BFR/CFR/PVC Free
-----------------	---

Solder Process Capability	Not applicable for solder process capability
---------------------------	--

Product Compliance Disclaimer

This information is provided based on reasonable inquiry of our suppliers and represents our current actual knowledge based on the information they provided. This information is subject to change. The part numbers that TE has identified as EU RoHS compliant have a maximum concentration of 0.1% by weight in homogenous materials for lead, hexavalent chromium, mercury, PBB, PBDE, DBP, BBP, DEHP, DIBP, and 0.01% for cadmium, or qualify for an exemption to these

limits as defined in the Annexes of Directive 2011/65/EU (RoHS2). Finished electrical and electronic equipment products will be CE marked as required by Directive 2011/65/EU. Components may not be CE marked. Additionally, the part numbers that TE has identified as EU ELV compliant have a maximum concentration of 0.1% by weight in homogenous materials for lead, hexavalent chromium, and mercury, and 0.01% for cadmium, or qualify for an exemption to these limits as defined in the Annexes of Directive 2000/53/EC (ELV). Regarding the REACH Regulation, the information TE provides on SVHC in articles for this part number is based on the latest European Chemicals Agency (ECHA) 'Guidance on requirements for substances in articles' posted at this URL: <https://echa.europa.eu/guidance-documents/guidance-on-reach>

Compatible Parts



TE Part # 281197-6
FF 187 REC 1.0-2.5MM2 PTBR



TE Part # 2150157-2
OCEAN_2.0_Applicator-E-110F140OV-REA



TE Part # 7-2150157-7
OCEAN_2.0_SPARE_PART_KIT-110F140OV



TE Part # 281197-5
FF 187 REC 1.0-2.5MM2 PTBR (RE REELING)



TE Part # 2150157-1
OCEAN_2.0_Applicator-E-110F140OV-REM



TE Part # 4-1579007-3
EXTRACTION TOOL KIT



TE Part # 1-1579007-4
EXTRACTION TOOL

Also in the Series | FASTIN-FASTON 250

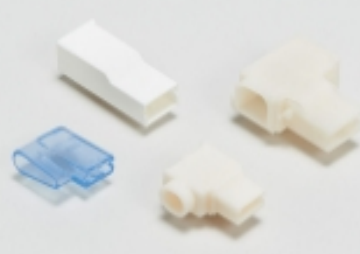

Crimp Terminal Housings(196)



Insertion & Extraction Tools(2)



PCB Terminals(1)



Quick Disconnects(220)

Customers Also Bought

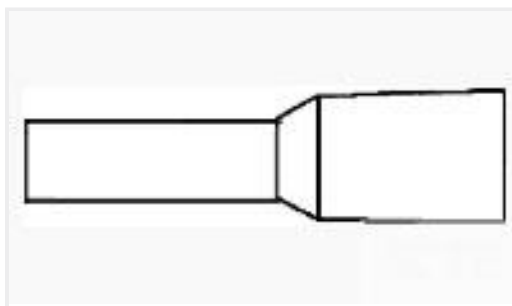

TE Part #966144-8
FER,WIRE,DBL,PL SLV,2.50/14,L10,
BLUE,LP



TE Part #1-102387-4
08 MODIV HSG COMP DR .100 POL



TE Part #2-2213767-1
AV19 SPL 3A MOVE RING LED WHITE
12V

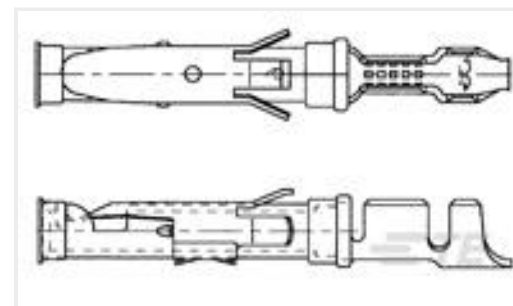

TE Part #1-163084-0
SPEC. PLATED



TE Part #2383365-1
V23136A0103X153-SZ-CBOX

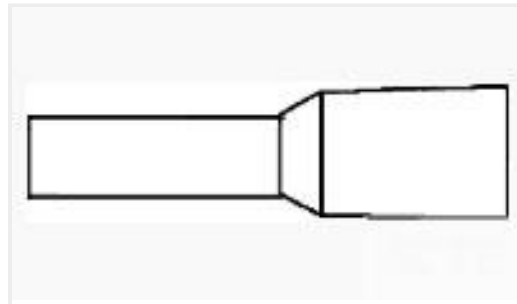

TE Part #2-966067-6
FER,WIRE,PL SLV,16.00/6,L12,BLUE,LP



TE Part #328527
TERMINAL,PG R 16-14 8

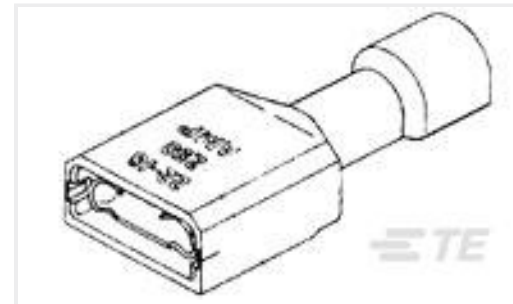

TE Part #7-520366-2
ULTRAFAST 110 ASSY REC 26-22
TPBR LP



TE Part #1-640250-0
10P SL156 HSG W/LCK RAMP NATL

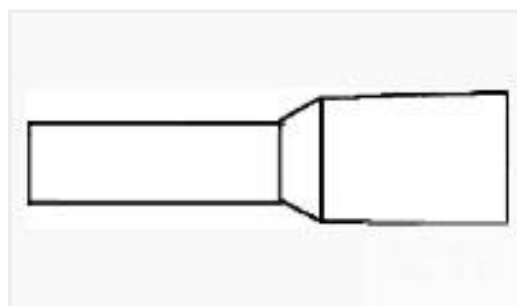

TE Part #966144-3
FER,WIRE,DBL,PL SLV,.75/18,L10,
GREY,LP

Documents

Product Drawings

[FF 250 REC 1-2.5MM2 PB](#)

English

CAD Files

[3D PDF](#)

3D

Customer View Model

[ENG_CVM_CVM_160917-3_P.2d_dxf.zip](#)

English

Customer View Model

[ENG_CVM_CVM_160917-3_P.3d_igs.zip](#)

English

Customer View Model

[ENG_CVM_CVM_160917-3_P.3d_stp.zip](#)

English

By downloading the CAD file I accept and agree to the [Terms and Conditions](#) of use.

Datasheets & Catalog Pages



1654742_HOUSEHOLD_APPLIANCES_RAST5

English

Product Specifications

Application Specification

German