

REVISIONS				
P	LTR	DESCRIPTION	DATE	APP'D
A1		REVISED PER ECR-17-012911	08SEP2017	WH DZ

POSITION 1 IDENTIFICATION FEATURE

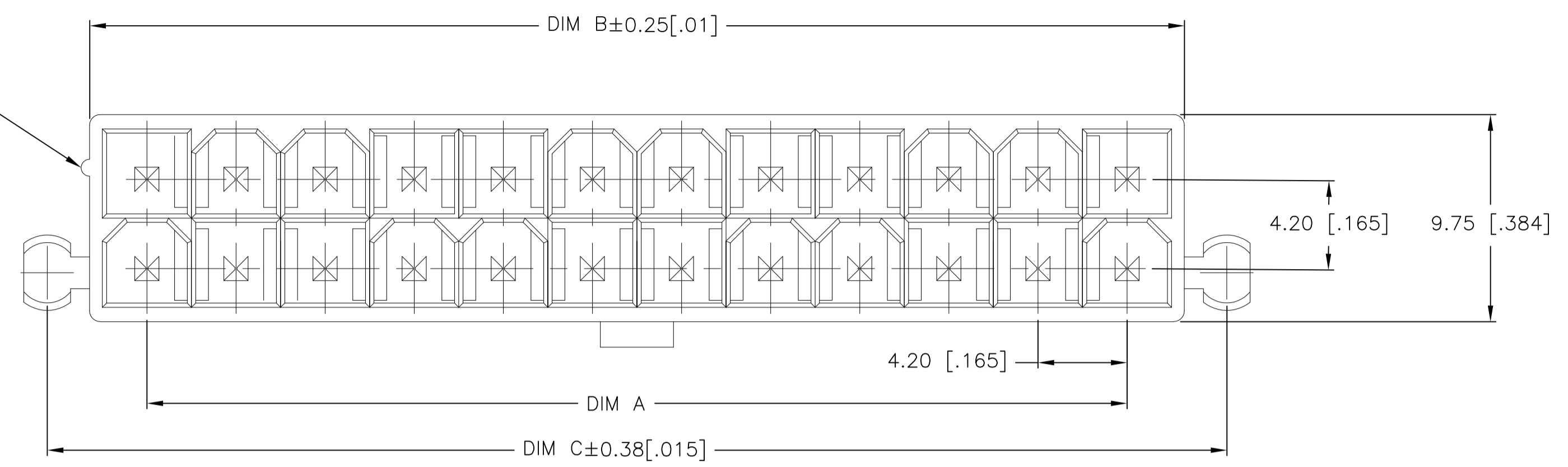

- 1 MATERIAL: HOUSING-NYLON, UL94V-0 (COLOR-NATURAL, COLOR OF PARTS MAY VARY) CONTACTS-0.25 [.010] THICK HIGH PERFORMANCE COPPER ALLOY.
- 2 CONTACT FINISH: POST-TIN PLATING.
- 3 MATES WITH VAL-U-LOK(TM) RECEPTACLE HOUSINGS: X-1586019-X(UL94-V0) X-1586765-X(UL94-V2,GLOW WIRE)

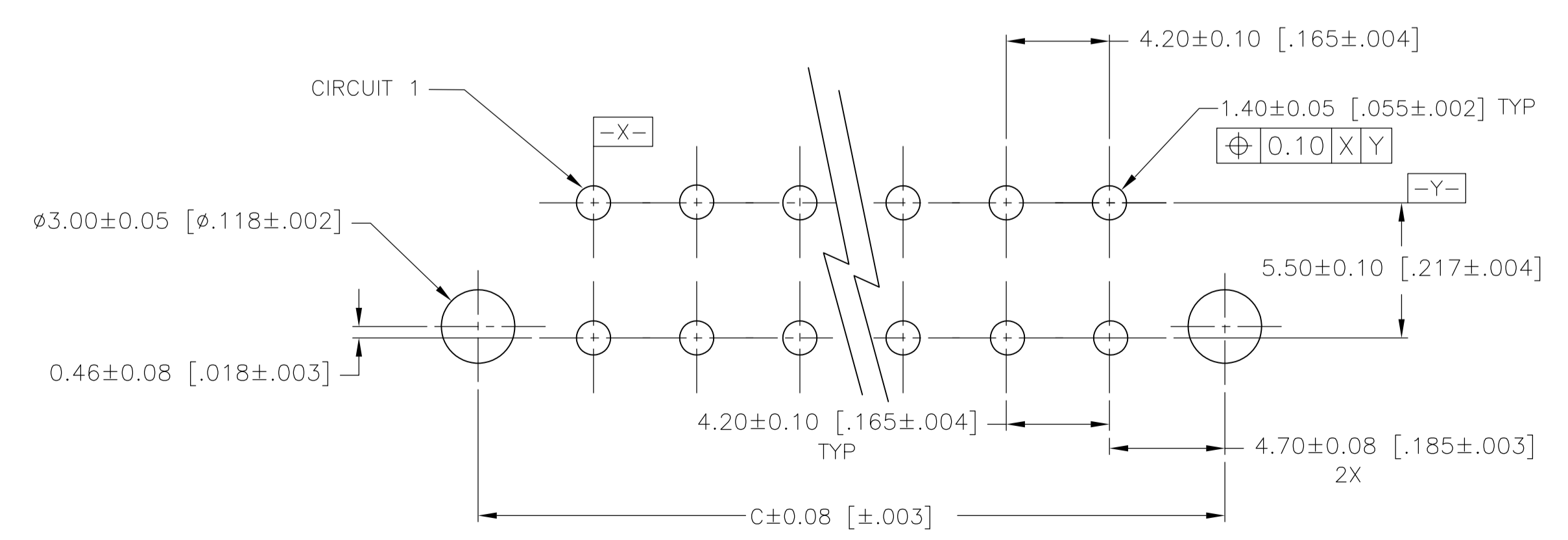
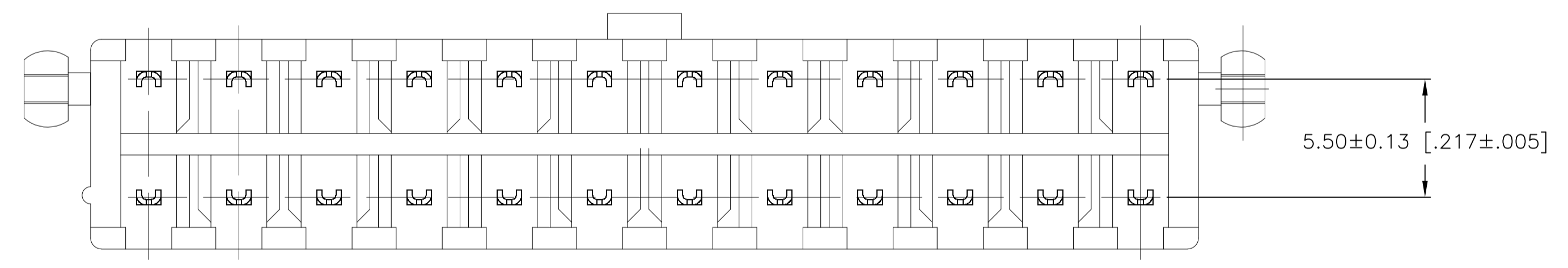
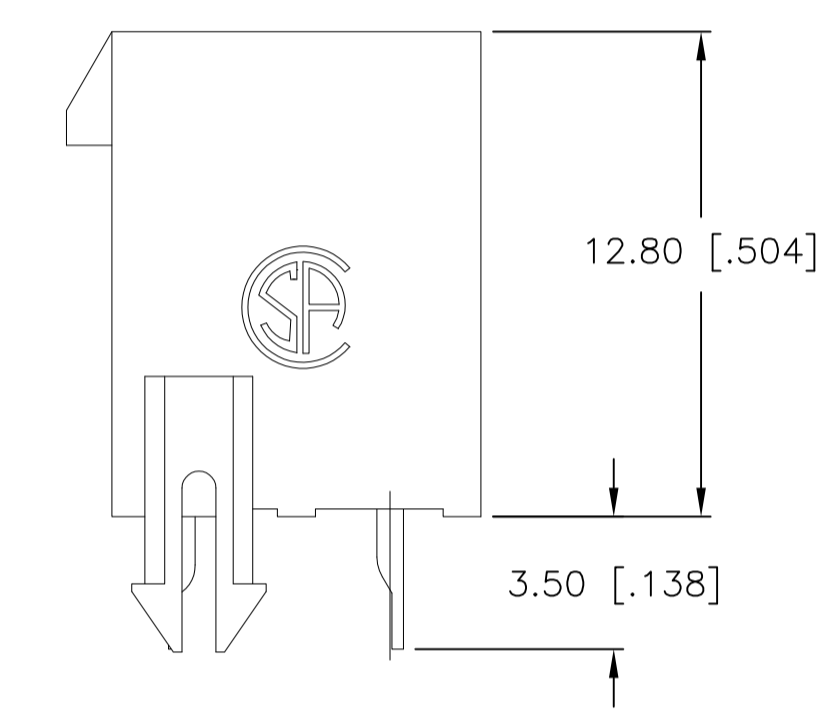
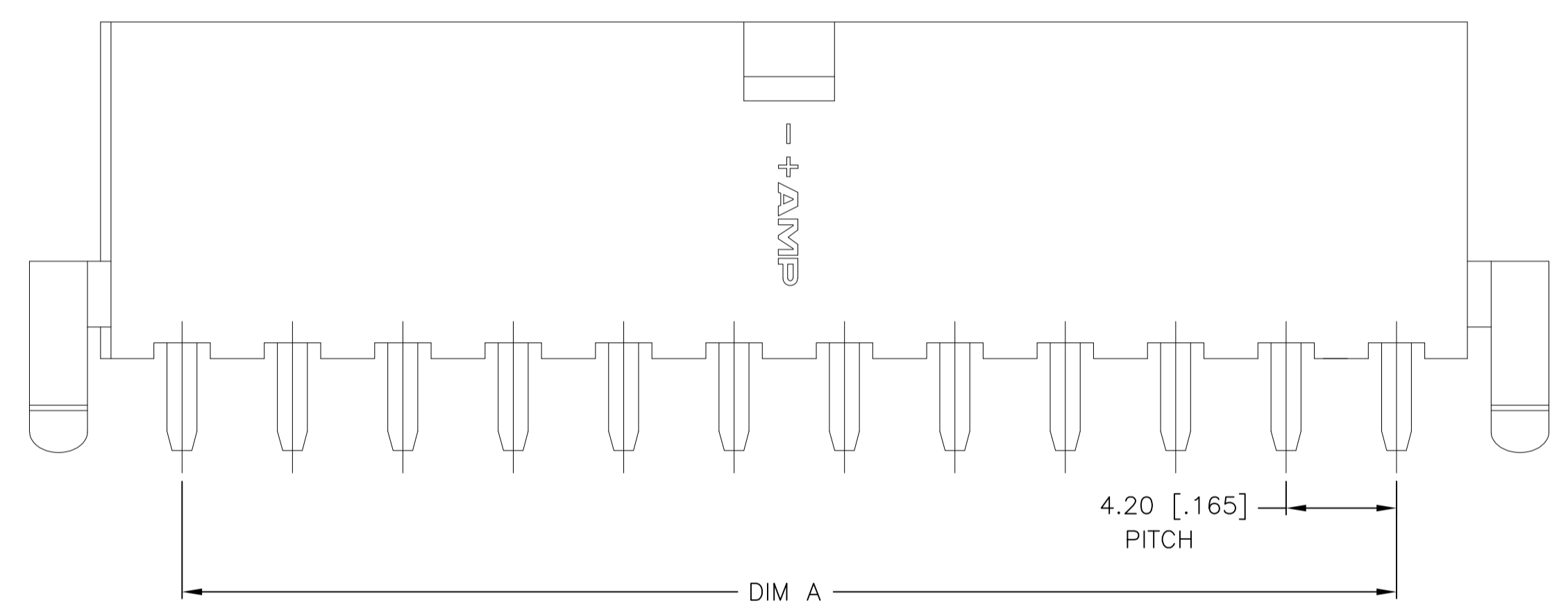
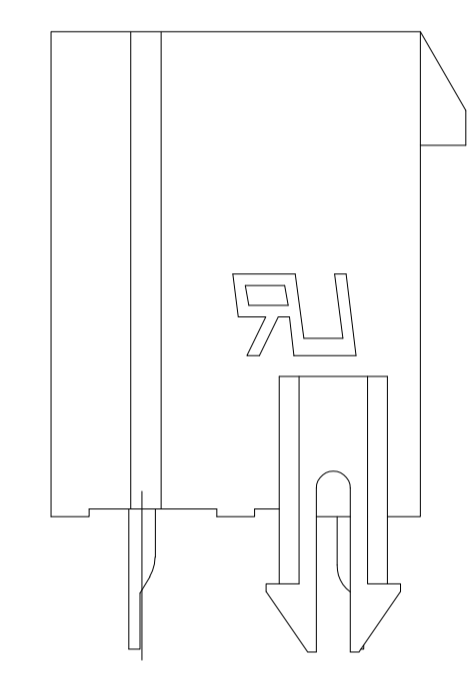

PCB LAYOUT: COMPONENT SIDE
RECOMMENDED BOARD THICKNESS 1.78 [.070]

24	46.2±0.25 [1.819±.01]	51.6 [2.031]	55.6 [2.189]	2-2825261-4
22	42.0±0.25 [1.654±.01]	47.4 [1.866]	51.4 [2.024]	2-2825261-2
20	37.8±0.25 [1.488±.01]	43.2 [1.701]	47.2 [1.858]	2-2825261-0
18	33.6±0.25 [1.323±.01]	39.0 [1.536]	43.0 [1.693]	1-2825261-8
16	29.4±0.25 [1.157±.01]	34.8 [1.370]	38.8 [1.528]	1-2825261-6
14	25.2±0.25 [.992±.01]	30.6 [1.205]	34.6 [1.362]	1-2825261-4
12	21.0±0.25 [.827±.01]	26.4 [1.039]	30.4 [1.197]	1-2825261-2
10	16.8±0.13 [.661±.005]	22.2 [.874]	26.2 [1.031]	1-2825261-0
8	12.6±0.13 [.496±.005]	18.0 [.709]	22.0 [.866]	2825261-8
6	8.4±0.13 [.331±.005]	13.8 [.543]	17.8 [.701]	2825261-6
4	4.2±0.13 [.165±.005]	9.6 [.378]	13.6 [.535]	2825261-4
2		5.4 [.213]	9.4 [.370]	2825261-2
POS	DIM A	DIM B	DIM C	PART NUMBER

THIS DRAWING IS A CONTROLLED DOCUMENT.

DIMENSIONS: mm [INCHES]	TOLERANCES UNLESS OTHERWISE SPECIFIED:	DIN WARREN HUO 15AUG2017	CHK DANIEL ZHANG 15AUG2017	NAME DANIEL ZHANG 15AUG2017
0 PLC ± .5 [.02]	1 PLC ± 0.25 [.010]	APPROD DANIEL ZHANG	PRODUCT SPEC 108-150000	APPLICATION SPEC 114-13172
MATERIAL	FINISH	WEIGHT	SIZE	CAGE CODE
		A1	00779	2825261
CUSTOMER DRAWING		SCALE	SHEET	REV
		N/A	1 OF 2	A1

STE TE Connectivity
VERTICAL HEADER WITH PEGS, WITH DRAIN HOLES VAL-U-LOK(TM), HCS

REVISIONS				
#	LR	DESCRIPTION	DATE	OWN
-	-	SEE SHEET 1	-	-

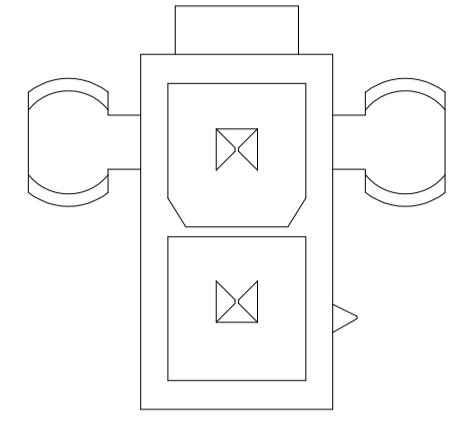

2825261-2

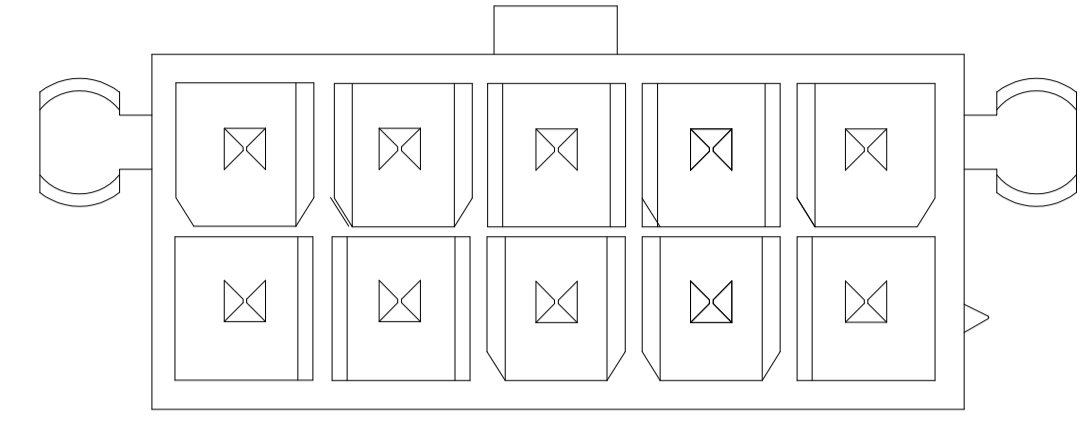

1-2825261-0

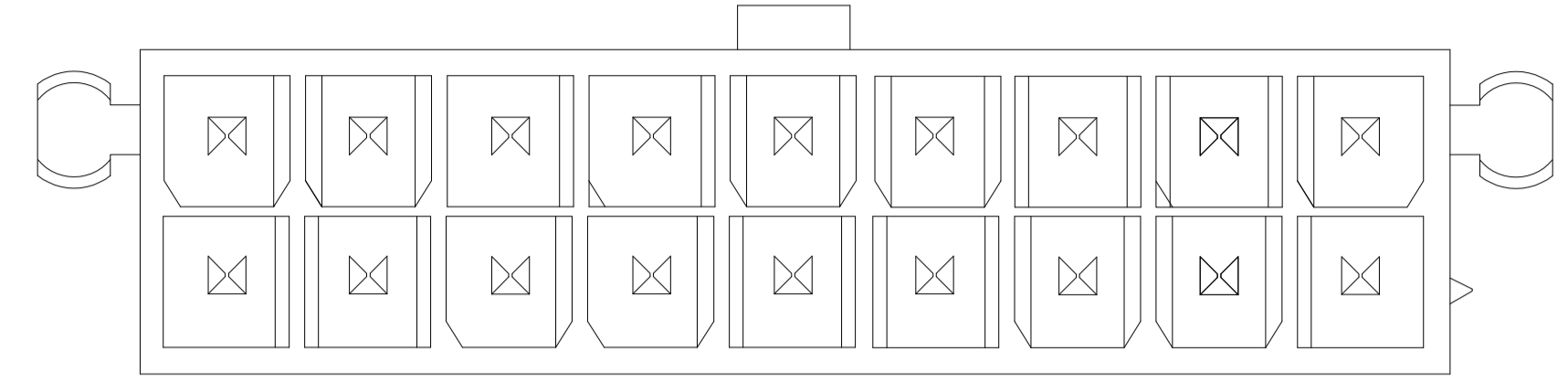

1-2825261-8

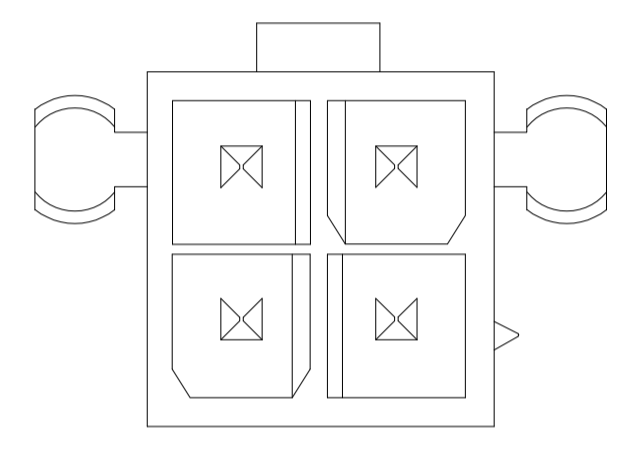

2825261-4

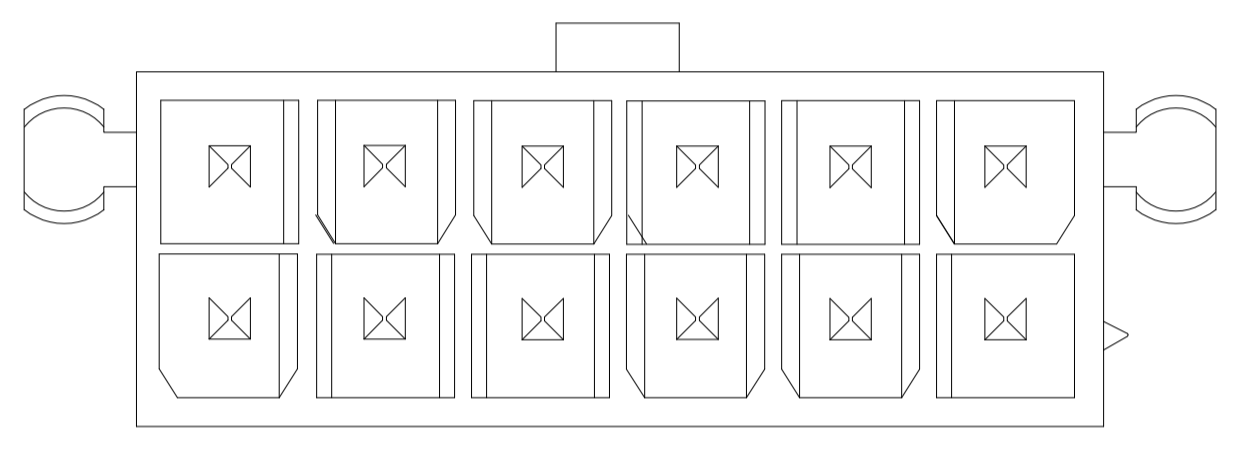

1-2825261-2

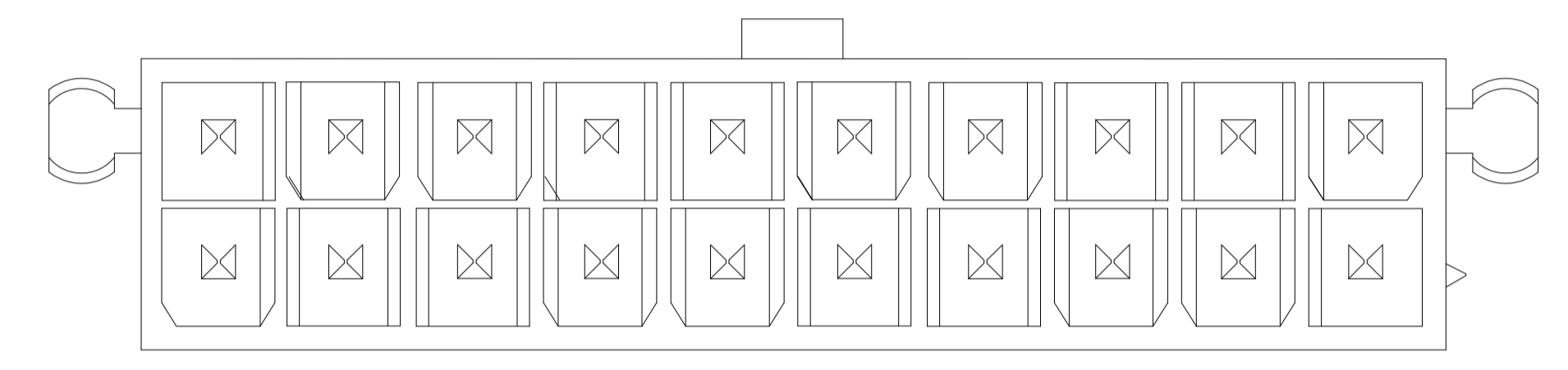

2-2825261-0

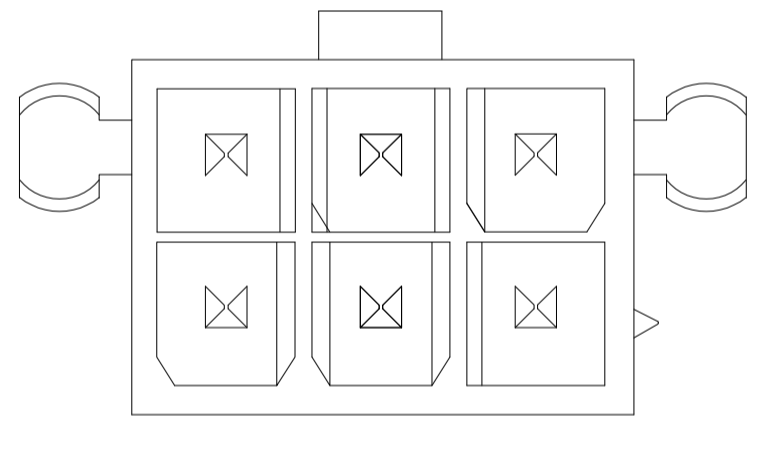

2825261-6

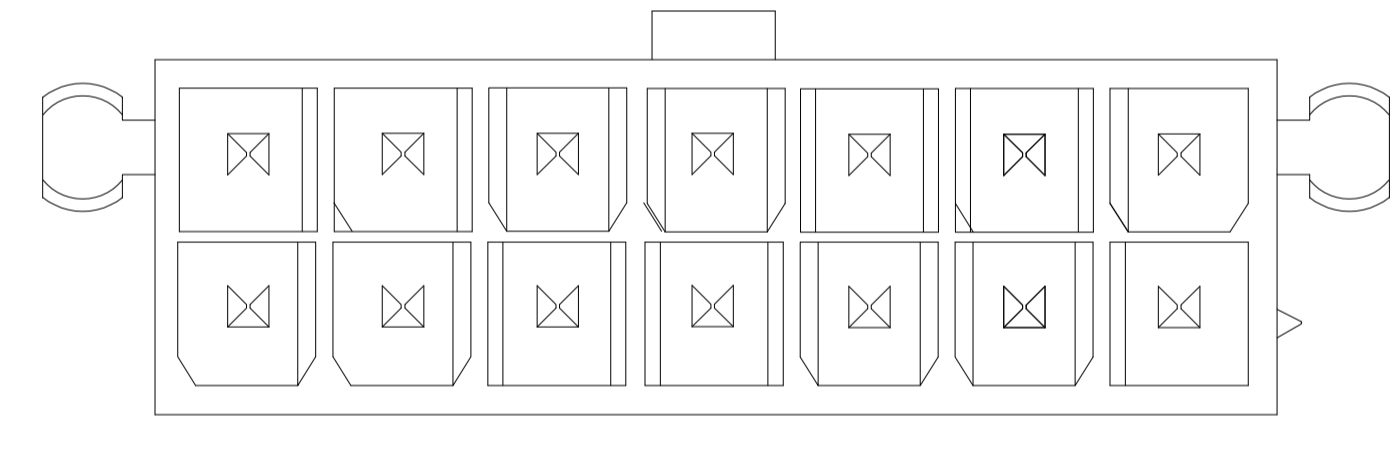

1-2825261-4

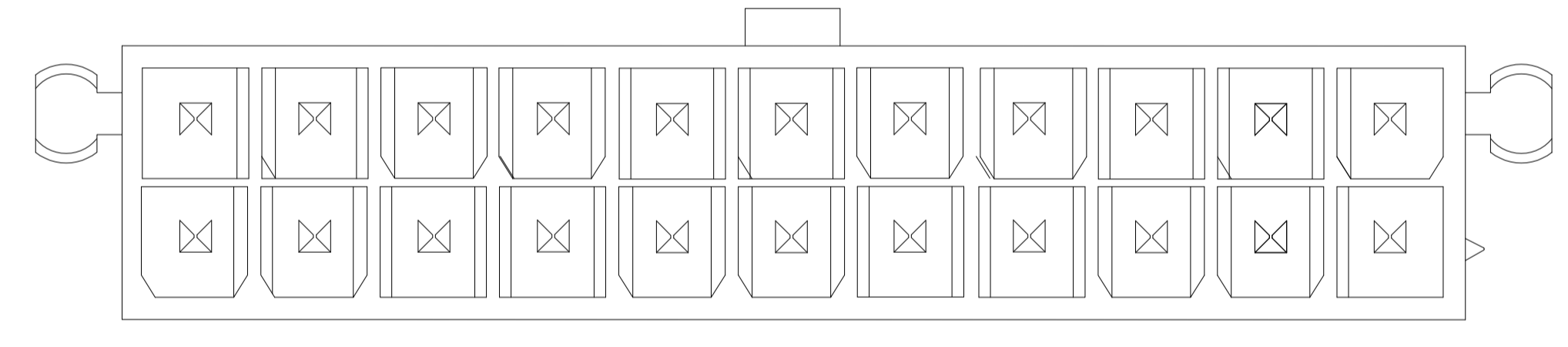

2-2825261-2

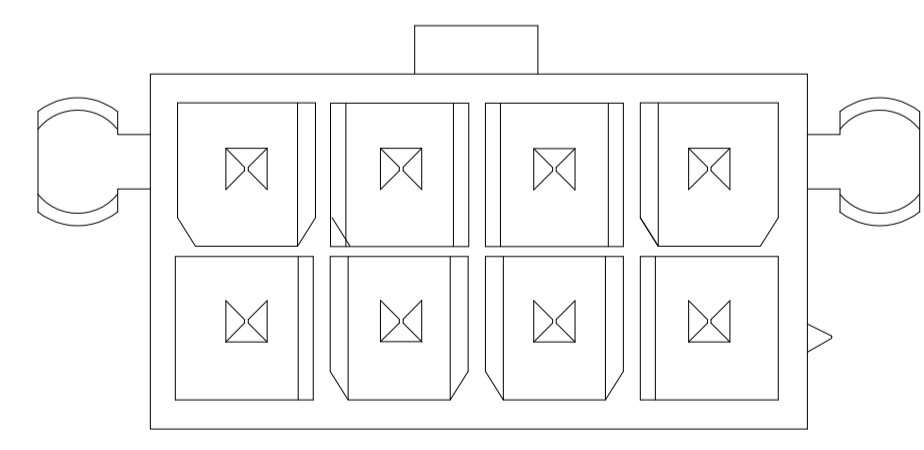

2825261-8

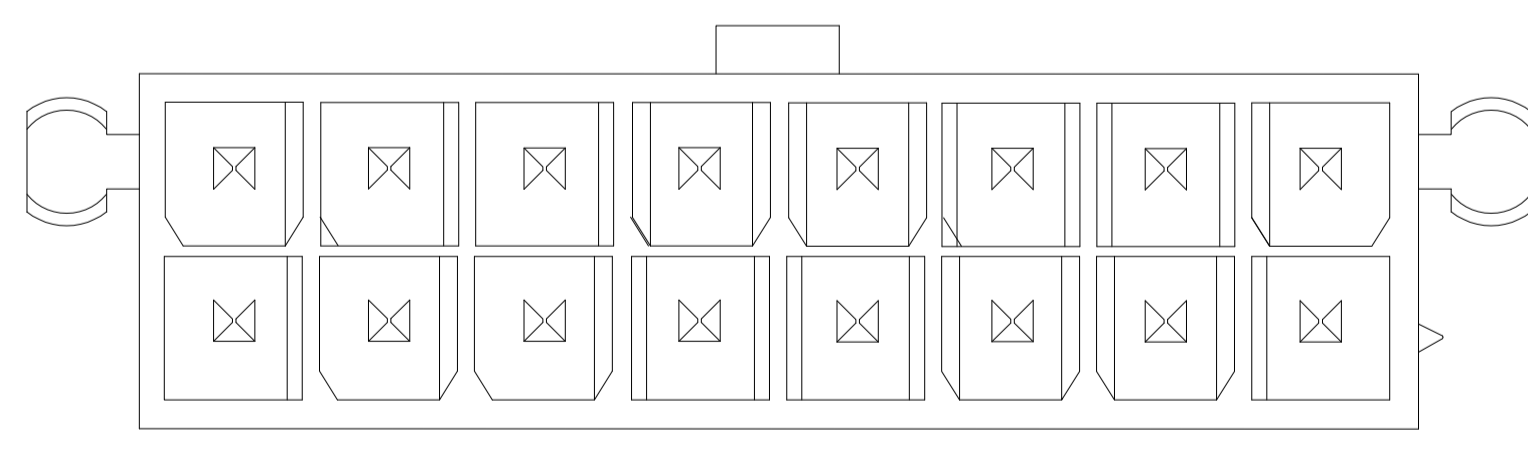

1-2825261-6

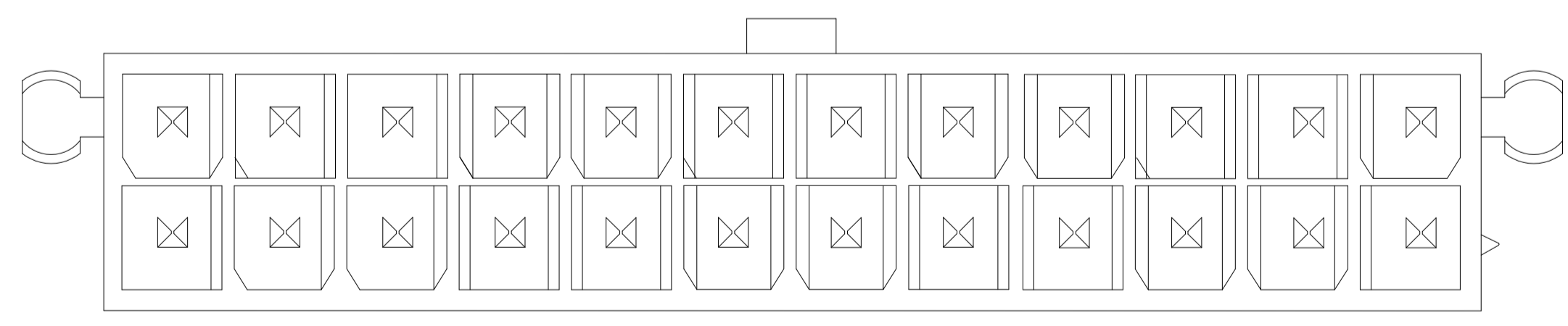

2-2825261-4

THIS DRAWING IS A CONTROLLED DOCUMENT.		OWN: WARREN HUO 15AUG2017	TE Connectivity VERTICAL HEADER WITH PEGS, WITH DRAIN HOLES VAL-U-LOK(TM), HCS
DIMENSIONS: mm [INCHES]		CHK: DANIEL ZHANG 15AUG2017	
TOLERANCES UNLESS OTHERWISE SPECIFIED:		APRO: DANIEL ZHANG 15AUG2017	NAME: 108-150000
0 PLC ± 1 PLC ± 0.5 [02] 2 PLC ± 0.25 [010] 3 PLC ± 4 PLC ± ANGLES ±		PRODUCT SPEC	SIZE: A1
MATERIAL FINISH		APPLICATION SPEC	CAGE CODE: 00779
		WEIGHT: 114-13172	DRAWING NO: 2825261
		CUSTOMER DRAWING	SCALE: N/A SHEET 2 OF 2 REV A1