

Data sheet | Item number: 254-452/000-004

PCB terminal block; 2.5 mm²; Pin spacing 5/5.08 mm; 2-pole; PUSH WIRE®;
2,50 mm²; black

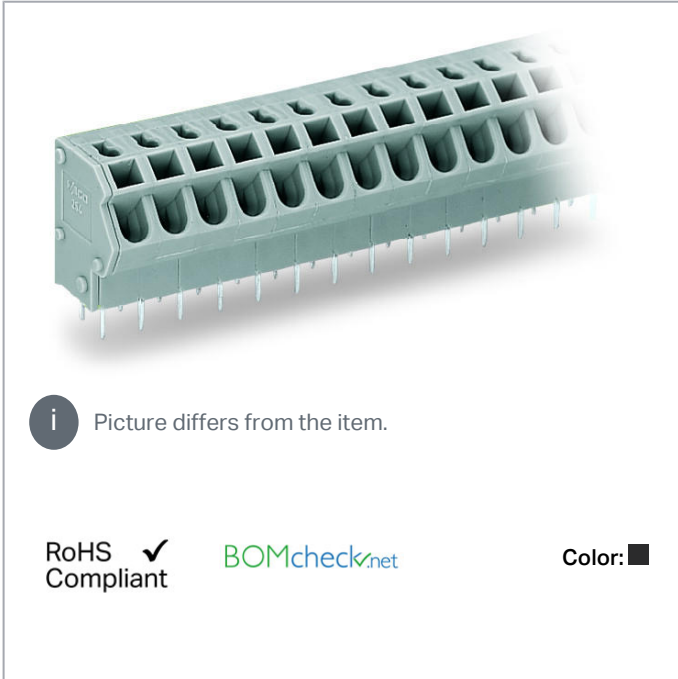

www.wago.com/254-452/000-004



i Picture differs from the item.

RoHS Compliant

BOMcheck.net

Color:

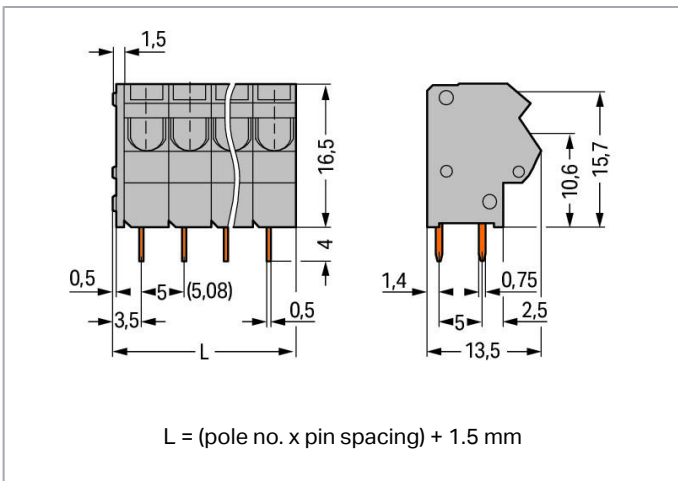
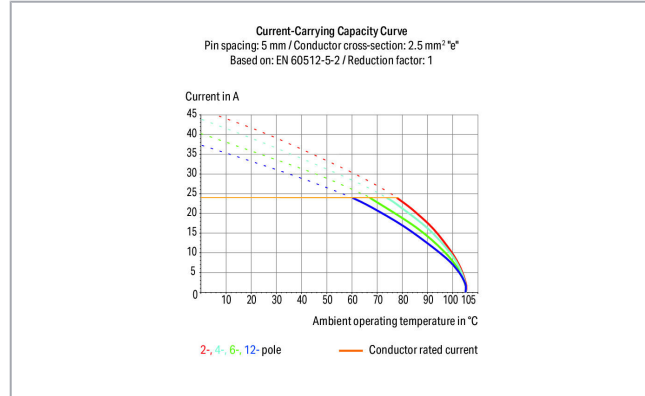

Item description

- PCB terminal strips with screwdriver-actuated PUSH WIRE® termination
- Push-in termination of solid and ferruled, fine-stranded conductors
- Test socket for 2 mm Ø test plug

Subject to changes. Please also observe the further product documentation!

WAGO Kontakttechnik GmbH & Co. KG
Hansastr. 27
32423 Minden
Phone: +49571 887-0 | Fax: +49571 887-169
Email: info.de@wago.com | Web: www.wago.com

Do you have any questions about our products?
We are always happy to take your call at +49 (571) 887-44222.



- Save space on the PCB, just 8.9 mm deep

Data

Electrical data

Ratings per IEC/EN

Ratings per	IEC/EN 60664-1
Nominal voltage (III/3)	320 V
Rated surge voltage (III/3)	4 kV
Rated voltage (III/2)	320 V
Rated surge voltage (III/2)	4 kV
Nominal voltage (II/2)	630 V
Rated surge voltage (II/2)	4 kV
Rated current	24 A
Legend (ratings)	(III / 2) \triangleq Overvoltage category III / Pollution degree 2

Ratings per UL

Approvals per	UL 1059
Rated voltage UL (Use Group B)	300 V
Rated current UL (Use Group B)	10 A
Rated voltage UL (Use Group D)	300 V
Rated current UL (Use Group D)	10 A

Ratings per CSA

Approvals per	CSA
Rated voltage CSA (Use Group B)	300 V
Rated current CSA (Use Group B)	10 A
Rated voltage CSA (Use Group D)	300 V
Rated current CSA (Use Group D)	10 A

Connection data

Connection technology	PUSH WIRE [®]
Actuation type	Operating tool
Solid conductor	0.5 ... 2.5 mm ² / 20 ... 12 AWG
Fine-stranded conductor; with insulated ferrule	0.5 ... 1.5 mm ²
Fine-stranded conductor; with uninsulated ferrule	0.5 ... 1.5 mm ²

Subject to changes. Please also observe the further product documentation!



Note (conductor cross-section)	12 AWG: THHN, THWN
Strip length	10 ... 12 mm / 0.39 ... 0.47 inch
Conductor connection direction to PCB	45°
Pole No.	2
Total number of connection points	2
Total number of potentials	2
Number of connection types	1
Number of levels	1

Physical data

Pin spacing	5/5.08 mm / 0.197/0.2 inch
Width	11.5 mm / 0.453 inch
Height	19.7 mm / 0.776 inch
Height from the surface	15.7 mm / 0.618 inch
Depth	13.5 mm / 0.531 inch
Solder pin length	4 mm
Solder pin dimensions	0.5 x 0.75 mm
Drilled hole diameter with tolerance	1.1 ^(+0.1) mm

PCB contact

PCB Contact	THT
Solder pin arrangement	over the entire terminal strip (in-line)
Number of solder pins per potential	2

Material data

Color	black
Material group	I
Insulation material	Polyamide (PA66)
Flammability class per UL94	V0
Clamping spring material	Chrome nickel spring steel (CrNi)
Contact material	Electrolytic copper (E _{Cu})
Contact plating	tin-plated
Weight	2.4 g

Environmental requirements

Limit temperature range	-60 ... +105 °C
-------------------------	-----------------

Subject to changes. Please also observe the further product documentation!



Commercial data

Packaging type	BOX
Country of origin	PL
GTIN	4055143741620
Customs tariff number	85369010000

Downloads

Documentation

Additional Information

Technical explanations	3. 4. 2019	pdf 2.0 MB	Download
------------------------	------------	---------------	----------

CAD/CAE-Data

PCB Design

Symbol and Footprint 254-452/000-004	URL	Download
--------------------------------------	-----	----------

CAX data for your PCB design, consisting of "schematic symbols and PCB footprints", allow easy integration of the WAGO component into your development environment.

Supported formats:

- Accel EDA 14 & 15
- Altium 6 to current version
- Cadence Allegro
- DesignSpark
- Eagle Libraries
- KiCad
- Mentor Graphics BoardStation
- Mentor Graphics Design Architect
- Mentor Graphics Design Expedition 99 and 2000
- OrCAD 9.X PCB and Capture
- PADS PowerPCB 3, 3.5, 4.X, and 5.X
- PADS PowerPCB and PowerLogic 3.0
- PCAD 2000, 2001, 2002, 2004, and 2006
- Pulsonix 8.5 or newer
- STL
- 3D STEP

—
Subject to changes. Please also observe the further product documentation!

WAGO Kontakttechnik GmbH & Co. KG
Hansastr. 27
32423 Minden
Phone: +49571 887-0 | Fax: +49571 887-169
Email: info.de@wago.com | Web: www.wago.com

Do you have any questions about our products?
We are always happy to take your call at +49 (571) 887-44222.

- TARGET 3001!
- View Logic ViewDraw
- Quadcept
- Zuken CadStar 3 and 4
- Zuken CR-5000 and CR-8000

PCB Component Libraries (EDA), PCB CAD Library Ultra Librarian

Environmental Product Compliance

Compliance Search

Environmental Product Compliance 254-452/000-004

URL

Download

PCB terminal block; 2.5 mm²; Pin spacing 5/5.08 mm; 2-pole; PUSH WIRE®; 2,50 mm²; black

Installation Notes

Conductor termination

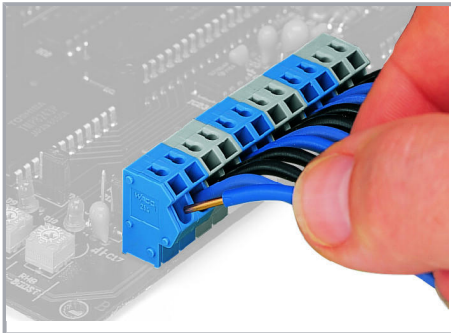

Insert solid conductors via push-in termination.

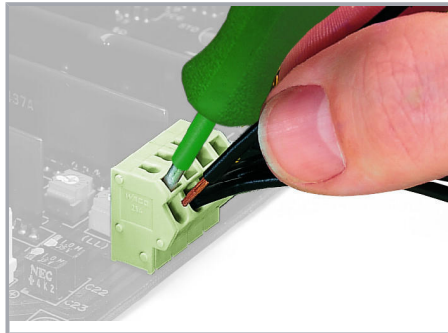

Inserting a tip-bonded conductor via screwdriver.

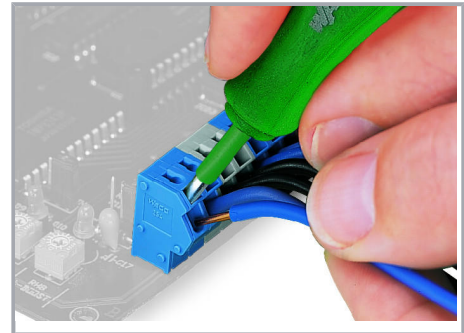

Removing a solid conductor.

Subject to changes. Please also observe the further product documentation!

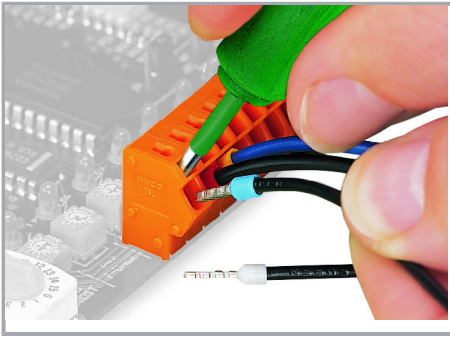

Inserting/removing a ferruled conductor.

Marking

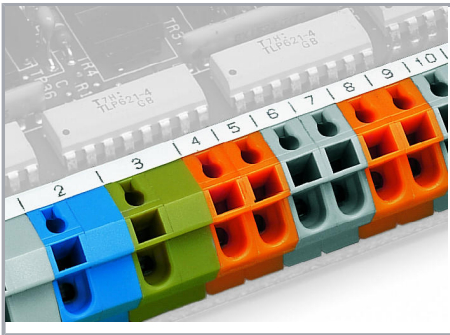

Labeling via self-adhesive marking strips.

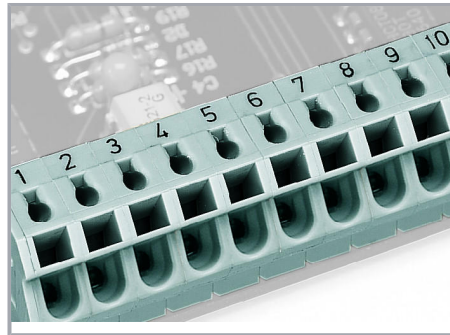

Labeling via factory direct marking.

Testing

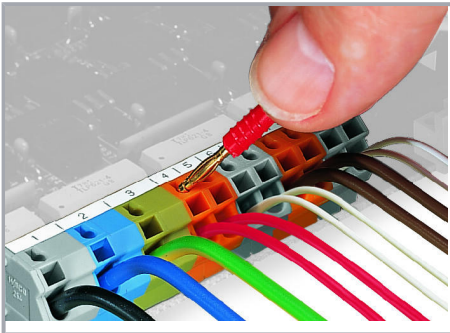

Testing with 2 mm Ø test plug.

Installation

Subject to changes. Please also observe the further product documentation!

WAGO Kontakttechnik GmbH & Co. KG
Hansastr. 27
32423 Minden
Phone: +49571 887-0 | Fax: +49571 887-169
Email: info.de@wago.com | Web: www.wago.com

Do you have any questions about our products?
We are always happy to take your call at +49 (571) 887-44222.

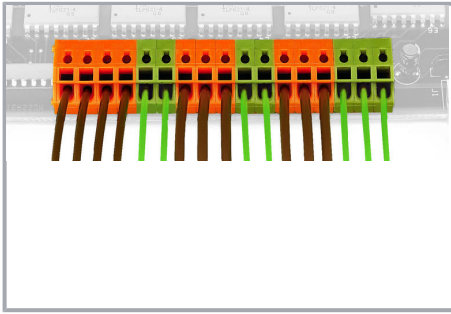

Mixed terminal strips can be assembled using different housing colors for the formation of groups.

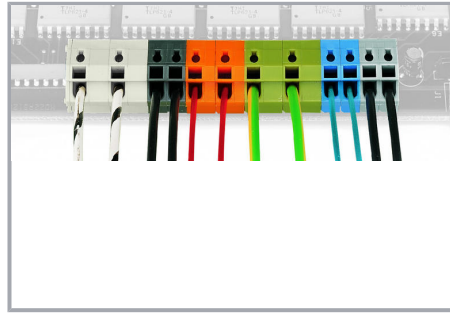

Mixed terminal strips can be assembled using different pin spacing and housing colors for the formation of groups.

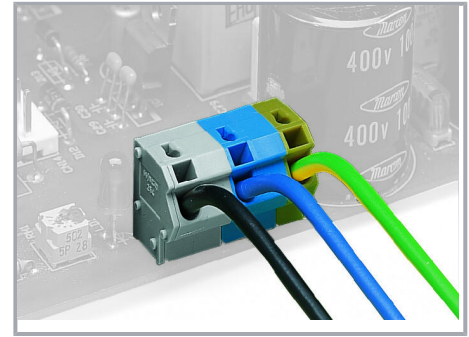

Application example: field-wiring terminal strip

Subject to changes. Please also observe the further product documentation!