

Data sheet | Item number: 770-1746/080-000

3-way distribution connector; 5-pole; Cod. B; 1 input; 3 outputs; pink

www.wago.com/770-1746/080-000

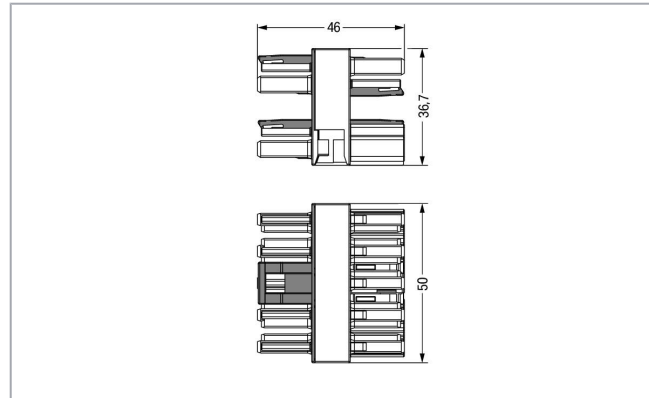
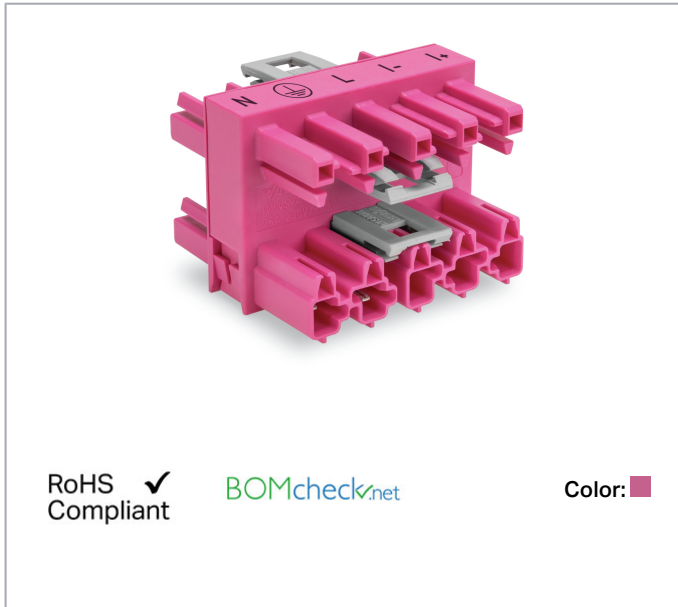

Item description

- Protected against mismatching and maintenance-free
- Additional variable coding is possible.
- Components can be clearly printed on and color-coded to meet custom requirements.

Data

Electrical data

Note on contact resistance

approx. 1 mΩ of contact resistance approx. 0.25 mΩ contact transition plug/socket

Ratings per IEC/EN

Ratings per	IEC/EN 60664-1
Nominal voltage (III/3)	400 V
Rated surge voltage (III/3)	6 kV
Rated current	25 A
Legend (ratings)	(III / 3) ≙ Overvoltage category III / Pollution degree 3

Subject to changes. Please also observe the further product documentation!

WAGO Kontakttechnik GmbH & Co. KG
Hansastr. 27
32423 Minden
Phone: +49571 887-0 | Fax: +49571 887-169
Email: info.de@wago.com | Web: www.wago.com

Do you have any questions about our products?
We are always happy to take your call at +49 (571) 887-44222.



Ratings per UL

Hinweis für den amerikanischen Markt	Application note for the U.S. market (USR): Some versions may also be used for current interruption in accordance with the UL certificate in select applications with currents below 16 A and voltages up to 600 V. For further information, please contact your local sales office.
Rated voltage UL 1977	600 V
Rated current UL 1977	23 A

Physical data

Pin spacing	10 mm / 0.394 inch
Width	50 mm / 1.968 inch
Height	36.7 mm / 1.445 inch
Depth	46 mm / 1.811 inch

Mechanical data

technology	SMI
Application	Measurement and regulation technology
Marking	N L I- I+
Potential marking	N L I- I+
Mating force of a plug-in connection	approx. 20 ... 70 N (depending on pole number)
Retention force of a plug-in connection	When locked: > 80 N
Unmating force of a plug-in connection	Unlocked: approx. 20 ... 70 N (depending on pole number)
Number of mating cycles	200, without resistive load
Distributor type	Distribution connector, 3-way,
Note on protection type	When mated: IP2xC (These compact connectors are not designed for use in open, easily accessible areas!)

Plug-in connection

Mismating protection	Yes
Note on mismating protection	All WINSTA [®] components are 100% protected against mismating when: a.) plugging different numbers of poles b.) plugging while rotated 180 c.) plugging while laterally staggered d.) plugging one pole
Hinweis zur Verriegelung	All connectors for mounted installations (snap-in versions for lighting fixtures or devices, all types of PCB and distribution connectors) are factory-equipped with locking levers to ensure plugs and sockets are securely locked. Additional locking levers are only required for flying leads (plug/socket).

Subject to changes. Please also observe the further product documentation!

Material data

Color	pink
Insulation material	Polyamide (PA66)
Contact material	Copper or copper alloy (surface-treated)
Fire load	0.736 MJ
Weight	44.3 g





Environmental requirements

Processing temperature	-5 ... +40 °C
Continuous operating temperature	-35 ... +85 °C
Note on continuous operating temperature	Insulating parts for temperatures ≤ 105 °C

Commercial data

Packaging type	BOX
Country of origin	DE
Customs tariff number	85366990990

Counterpart

	Item no. 770-285/080-000 Socket; 5-pole; Cod. B; 4,00 mm ² ; pink	www.wago.com/770-285/080-000
	Item no. 770-295/080-000 Plug; 5-pole; Cod. B; 4,00 mm ² ; pink	www.wago.com/770-295/080-000
	Item no. 771-9935/006-107/080-000 pre-assembled interconnecting cable; Eca; Socket/plug; 5-pole; Cod. B; H05VV-F 5G 1.5 mm ² ; 1 m; 1,50 mm ² ; pink	www.wago.com/771-9935/006-107/080-000
	Item no. 771-9935/106-107/080-000 pre-assembled connecting cable; Eca; Socket/open-ended; 5-pole; Cod. B; H05VV-F 5G 1.5 mm ² ; 1 m; 1,50 mm ² ; pink	www.wago.com/771-9935/106-107/080-000
	Item no. 771-9935/206-307/080-000 pre-assembled connecting cable; Eca; Plug/open-ended; 5-pole; Cod. B; H05VV-F 5G 1.5 mm ² ; 3 m; 1,50 mm ² ; pink	www.wago.com/771-9935/206-307/080-000

Required accessories

protection

	Item no.: 770-201 Lockout cap; 12-pole, separable; 12-pole; for sockets; black	www.wago.com/770-201
--	---	--

Subject to changes. Please also observe the further product documentation!



Item no.: 770-221
Lockout cap; for socket; 12-pole; separable; white

www.wago.com/770-221



Item no.: 770-360
Lockout cap; for plugs; 5-pole; separable; yellow

www.wago.com/770-360

Downloads

Documentation

Bid Text

770-1746/080-000 X81 - Datei	19. 2. 2019	xml 2.9 kB	Download
770-1746/080-000 doc - Datei	29. 9. 2017	doc 23.6 kB	Download

Environmental Product Compliance

Compliance Search

Environmental Product Compliance 770-1746/080-000 3-way distribution connector; 5-pole; Cod. B; 1 input; 3 outputs; pink	URL	Download
---	-----	----------

Installation Notes

Installation

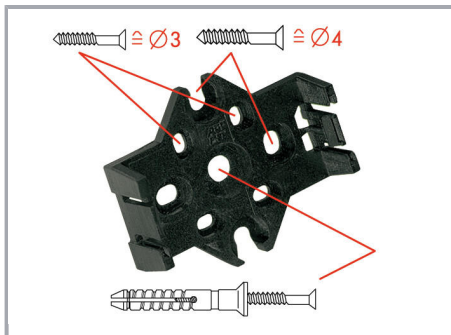

Mounting plates can be secured using commercially available screws or nail-drive anchors.



The distribution connectors snap together when attached to the mounting plate.



To release the distribution connector, unlock the latch using a screwdriver.

Subject to changes. Please also observe the further product documentation!

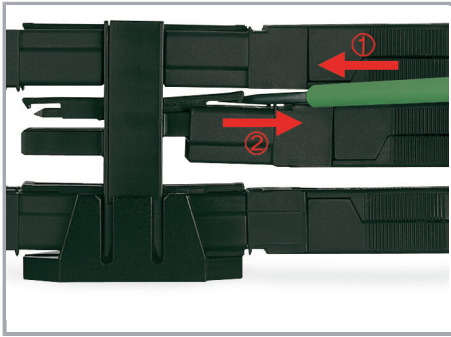

All distribution connector connections are locked and protected against accidental disconnection directly after mating. Locking of any connection is released using a screwdriver, even if all connections are used.

Product family

WINSTA® MIDI

[Show all products from the family](#)

Subject to changes. Please also observe the further product documentation!