

Data sheet | Item number: 2202-1772

3-conductor disconnect/test terminal block; with push-button; with test option; orange disconnect link; for DIN-rail 35 x 15 and 35 x 7.5; 2.5 mm²; Push-in CAGE CLAMP®; 2,50 mm²; orange

www.wago.com/2202-1772

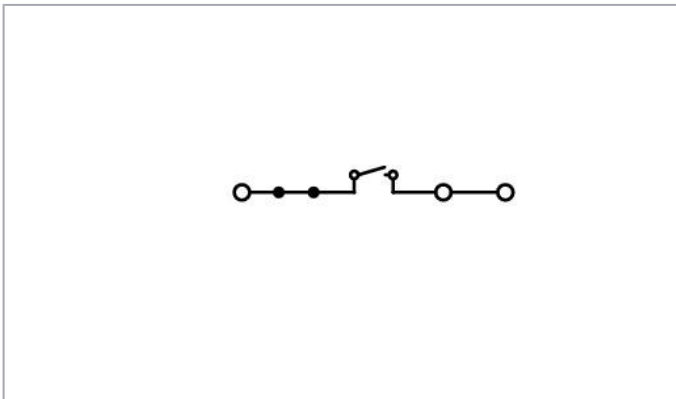
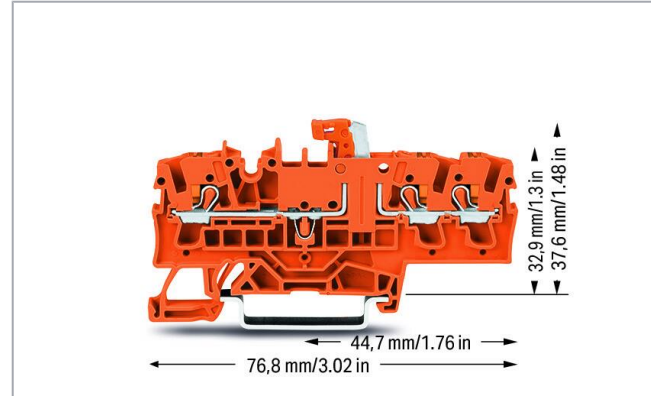
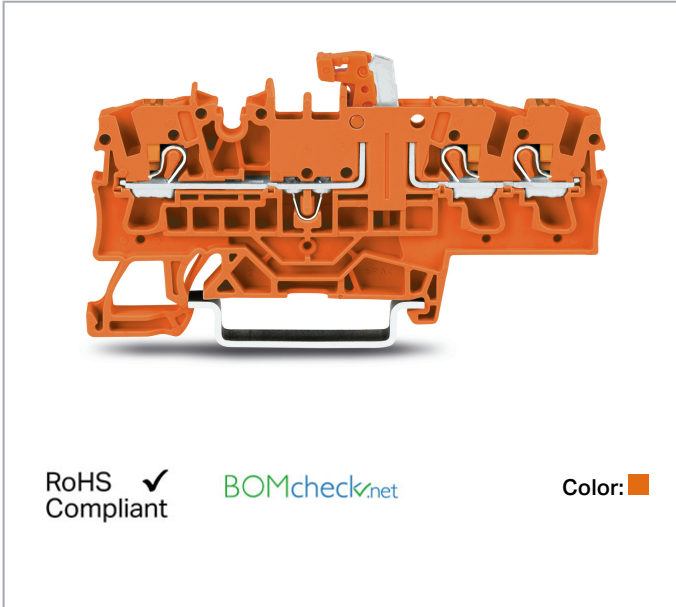

Data

Electrical data

Ratings per IEC/EN

Ratings per	IEC/EN 60947-7-1
Nominal voltage (III/3)	400 V
Rated surge voltage (III/3)	6 kV
Rated current	16 A

Subject to changes. Please also observe the further product documentation!

WAGO Kontakttechnik GmbH & Co. KG
Hansastr. 27
32423 Minden
Phone: +49571 887-0 | Fax: +49571 887-169
Email: info.de@wago.com | Web: www.wago.com

Do you have any questions about our products?
We are always happy to take your call at +49 (571) 887-44222.

Legend (ratings)

(III / 3) ≙ Overvoltage category III / Pollution degree 3

Ratings per UL

Approvals per	UL 1059
Rated voltage UL (Use Group B)	300 V
Rated current UL (Use Group B)	15 A
Rated voltage UL (Use Group C)	300 V
Rated current UL (Use Group C)	15 A

Ratings per CSA

Approvals per	C22.2 No 158
Rated voltage CSA (Use Group B)	300 V
Rated current CSA (Use Group B)	15 A
Rated voltage CSA (Use Group C)	300 V
Rated current CSA (Use Group C)	15 A

Connection data

Connection technology	Push-in CAGE CLAMP®
Actuation type	Push-in Push-button Operating tool
Connectable conductor materials	Copper
Nominal cross-section	2.5 mm ²
Solid conductor	0.25 ... 4 mm ² / 22 ... 12 AWG
Solid conductor; push-in termination	0.75 ... 4 mm ² / 18 ... 12 AWG
Fine-stranded conductor	0.25 ... 4 mm ² / 22 ... 12 AWG
Fine-stranded conductor; with insulated ferrule	1 ... 2.5 mm ² / 18 ... 14 AWG
Fine-stranded conductor; with ferrule; push-in termination	1 ... 2.5 mm ² / 18 ... 14 AWG
Note (conductor cross-section)	Depending on the conductor characteristic, a conductor with a smaller cross-section can also be inserted via push-in termination.
Strip length	10 ... 12 mm / 0.39 ... 0.47 inch
Total number of connection points	3
Total number of potentials	1
Number of levels	1
Wiring type	Front-entry wiring
Number of jumper slots	2

Subject to changes. Please also observe the further product documentation!

Physical data

Width	5.2 mm / 0.205 inch
Height	76.8 mm / 3.024 inch

Mechanical data

Design	horizontal type
Mounting type	DIN-35 rail
Marking level	Center/side marking

Material data



Color	orange
Insulation material	Polyamide (PA66)
Weight	8.9 g

Commercial data

Packaging type	BOX
Country of origin	DE
GTIN	4055143961141
Customs tariff number	85365080900

Approvals / Certificates

Ex-Approvals

Logo	Approval	Additional Approval Text	Certificate name
	AEx Underwriters Laboratories Inc.	UL 60079	E185892
	CCCEX CQST/CNEX	CNCA-C23-01	2020312313000288



UL-Approvals

Logo	Approval	Additional Approval Text	Certificate name
	UL Underwriters Laboratories Inc.	UL 1059	E45172

Subject to changes. Please also observe the further product documentation!



Required accessories

End plate









	Item no.: 2002-1791 End and intermediate plate; 1 mm thick; gray	www.wago.com/2002-1791
	Item no.: 2002-1792 End and intermediate plate; 1 mm thick; orange	www.wago.com/2002-1792

Compatible products















tools

	Item no.: 210-658 Operating tool; Blade: 3.5 x 0.5 mm; with a partially insulated shaft; angled; short; multicoloured	www.wago.com/210-658
	Item no.: 210-720 Operating tool; Blade: 3.5 x 0.5 mm; with a partially insulated shaft; multicoloured	www.wago.com/210-720

Marking accessories

	Item no.: 2002-121 Adaptor; gray	www.wago.com/2002-121
	Item no.: 2002-161 Adaptor; gray	www.wago.com/2002-161
	Item no.: 2009-110 Marking strips; for Smart Printer; on reel; not stretchable; plain; snap-on type; white	www.wago.com/2009-110
	Item no.: 2009-115 WMB-Inline; for Smart Printer; 1500 pieces on roll; stretchable 5 - 5.2 mm; plain; snap-on type; white	www.wago.com/2009-115
	Item no.: 2009-115/000-002 WMB-Inline; for Smart Printer; 1500 pieces on roll; stretchable 5 - 5.2 mm; plain; snap-on type; yellow	www.wago.com/2009-115/000-002
	Item no.: 2009-115/000-005 WMB-Inline; for Smart Printer; 1500 pieces on roll; stretchable 5 - 5.2 mm; plain; snap-on type; red	www.wago.com/2009-115/000-005
	Item no.: 2009-115/000-006 WMB-Inline; for Smart Printer; 1500 pieces on roll; stretchable 5 - 5.2 mm; plain; snap-on type; blue	www.wago.com/2009-115/000-006
	Item no.: 2009-115/000-007 WMB-Inline; for Smart Printer; 1500 pieces on roll; stretchable 5 - 5.2 mm; plain; snap-on type; gray	www.wago.com/2009-115/000-007

Subject to changes. Please also observe the further product documentation!

	Item no.: 2009-115/000-012 WMB-Inline; for Smart Printer; 1500 pieces on roll; stretchable 5 - 5.2 mm; plain; snap-on type; orange	www.wago.com/2009-115/000-012
	Item no.: 2009-115/000-017 WMB-Inline; for Smart Printer; 1500 pieces on roll; stretchable 5 - 5.2 mm; plain; snap-on type; light green	www.wago.com/2009-115/000-017
	Item no.: 2009-115/000-023 WMB-Inline; for Smart Printer; 1500 pieces on roll; stretchable 5 - 5.2 mm; plain; snap-on type; green	www.wago.com/2009-115/000-023
	Item no.: 2009-115/000-024 WMB-Inline; for Smart Printer; 1500 pieces on roll; stretchable 5 - 5.2 mm; plain; snap-on type; violet	www.wago.com/2009-115/000-024
	Item no.: 2009-145 Mini-WSB Inline; for Smart Printer; 1700 pieces on roll; stretchable 5 - 5.2 mm; plain; snap-on type; white	www.wago.com/2009-145
	Item no.: 2009-145/000-002 Mini-WSB Inline; for Smart Printer; 1700 pieces on roll; stretchable 5 - 5.2 mm; plain; snap-on type; yellow	www.wago.com/2009-145/000-002
	Item no.: 2009-145/000-005 Mini-WSB Inline; for Smart Printer; 1700 pieces on roll; stretchable 5 - 5.2 mm; plain; snap-on type; red	www.wago.com/2009-145/000-005
	Item no.: 2009-145/000-006 Mini-WSB Inline; for Smart Printer; 1700 pieces on roll; stretchable 5 - 5.2 mm; plain; snap-on type; blue	www.wago.com/2009-145/000-006
	Item no.: 2009-145/000-007 Mini-WSB Inline; for Smart Printer; 1700 pieces on roll; stretchable 5 - 5.2 mm; plain; snap-on type; gray	www.wago.com/2009-145/000-007
	Item no.: 2009-145/000-012 Mini-WSB Inline; for Smart Printer; 1700 pieces on roll; stretchable 5 - 5.2 mm; plain; snap-on type; orange	www.wago.com/2009-145/000-012
	Item no.: 2009-145/000-023 Mini-WSB Inline; for Smart Printer; 1700 pieces on roll; stretchable 5 - 5.2 mm; plain; snap-on type; green	www.wago.com/2009-145/000-023
	Item no.: 2009-145/000-024 Mini-WSB Inline; for Smart Printer; 1700 pieces on roll; stretchable 5 - 5.2 mm; plain; snap-on type; violet	www.wago.com/2009-145/000-024
	Item no.: 2009-191 Group marker carrier	www.wago.com/2009-191
	Item no.: 2009-192 Group marker carrier	www.wago.com/2009-192

Subject to changes. Please also observe the further product documentation!



Item no.: 2009-193
Group marker carrier

www.wago.com/2009-193



Item no.: 2009-198
Adaptor; gray

www.wago.com/2009-198



Item no.: 248-501
Miniature WSB Quick marking system; plain; Marker width 5 mm; 10 strips with 10 markers per card

www.wago.com/248-501



Item no.: 248-501/000-002
Mini-WSB marking card; as card; not stretchable; plain; snap-on type; yellow

www.wago.com/248-501/000-002



Item no.: 248-501/000-005
Mini-WSB marking card; as card; not stretchable; plain; snap-on type; red

www.wago.com/248-501/000-005



Item no.: 248-501/000-006
Mini-WSB marking card; as card; not stretchable; plain; snap-on type; blue

www.wago.com/248-501/000-006



Item no.: 248-501/000-007
Mini-WSB marking card; as card; not stretchable; plain; snap-on type; gray

www.wago.com/248-501/000-007



Item no.: 248-501/000-012
Mini-WSB marking card; as card; not stretchable; plain; snap-on type; orange

www.wago.com/248-501/000-012



Item no.: 248-501/000-017
Mini-WSB marking card; as card; not stretchable; plain; snap-on type; light green

www.wago.com/248-501/000-017



Item no.: 248-501/000-023
Mini-WSB marking card; as card; not stretchable; plain; snap-on type; green

www.wago.com/248-501/000-023



Item no.: 248-501/000-024
Mini-WSB marking card; as card; not stretchable; plain; snap-on type; violet

www.wago.com/248-501/000-024



Item no.: 793-501
WMB marking card; as card; not stretchable; plain; snap-on type; white

www.wago.com/793-501



Item no.: 793-501/000-002
WMB marking card; as card; not stretchable; plain; snap-on type; yellow

www.wago.com/793-501/000-002



Item no.: 793-501/000-005
WMB marking card; as card; not stretchable; plain; snap-on type; red

www.wago.com/793-501/000-005

Subject to changes. Please also observe the further product documentation!



Item no.: 793-501/000-006
WMB marking card; as card; not stretchable; plain; snap-on type; blue

www.wago.com/793-501/000-006



Item no.: 793-501/000-007
WMB marking card; as card; not stretchable; plain; snap-on type; gray

www.wago.com/793-501/000-007



Item no.: 793-501/000-012
WMB marking card; as card; not stretchable; plain; snap-on type; orange

www.wago.com/793-501/000-012



Item no.: 793-501/000-017
WMB marking card; as card; not stretchable; plain; snap-on type; light green

www.wago.com/793-501/000-017



Item no.: 793-501/000-023
WMB marking card; as card; not stretchable; plain; snap-on type; green

www.wago.com/793-501/000-023



Item no.: 793-501/000-024
WMB marking card; as card; not stretchable; plain; snap-on type; violet

www.wago.com/793-501/000-024



Item no.: 793-5501
WMB marking card; as card; for terminal block width 5 - 17.5 mm; stretchable 5 - 5.2 mm; plain; snap-on type; white

www.wago.com/793-5501



Item no.: 793-5501/000-002
WMB marking card; as card; for terminal block width 5 - 17.5 mm; stretchable 5 - 5.2 mm; plain; snap-on type; yellow

www.wago.com/793-5501/000-002



Item no.: 793-5501/000-005
WMB marking card; as card; for terminal block width 5 - 17.5 mm; stretchable 5 - 5.2 mm; plain; snap-on type; red

www.wago.com/793-5501/000-005



Item no.: 793-5501/000-006
WMB marking card; as card; for terminal block width 5 - 17.5 mm; stretchable 5 - 5.2 mm; plain; snap-on type; blue

www.wago.com/793-5501/000-006



Item no.: 793-5501/000-007
WMB marking card; as card; for terminal block width 5 - 17.5 mm; stretchable 5 - 5.2 mm; plain; snap-on type; gray

www.wago.com/793-5501/000-007



Item no.: 793-5501/000-012
WMB marking card; as card; for terminal block width 5 - 17.5 mm; stretchable 5 - 5.2 mm; plain; snap-on type; orange

www.wago.com/793-5501/000-012



Item no.: 793-5501/000-014
WMB marking card; as card; for terminal block width 5 - 17.5 mm; stretchable 5 - 5.2 mm; plain; snap-on type; brown

www.wago.com/793-5501/000-014

Item no.: 793-5501/000-017

Subject to changes. Please also observe the further product documentation!



WMB marking card; as card; for terminal block width 5 - 17.5 mm; stretchable 5 - 5.2 mm; plain; snap-on type; green

www.wago.com/793-5501/000-017



Item no.: 793-5501/000-023

WMB marking card; as card; for terminal block width 5 - 17.5 mm; stretchable 5 - 5.2 mm; plain; snap-on type; light green

www.wago.com/793-5501/000-023



Item no.: 793-5501/000-024

WMB marking card; as card; for terminal block width 5 - 17.5 mm; stretchable 5 - 5.2 mm; plain; snap-on type; violet

www.wago.com/793-5501/000-024

Push-In type wire jumper



Item no.: 2009-412

Push-in type wire jumper; insulated; 60 mm long; black

www.wago.com/2009-412



Item no.: 2009-414

Push-in type wire jumper; 1.5 mm²; insulated; 110 mm long; black

www.wago.com/2009-414



Item no.: 2009-414/000-005

Push-in type wire jumper; 1.5 mm²; insulated; 110 mm long; black

www.wago.com/2009-414/000-005



Item no.: 2009-414/000-006

Push-in type wire jumper; insulated; 110 mm long; black

www.wago.com/2009-414/000-006



Item no.: 2009-416

Push-in type wire jumper; 1.5 mm²; insulated; 250 mm long; black

www.wago.com/2009-416

Carrier rail



Item no.: 210-112

Steel carrier rail; 35 x 7.5 mm; 1 mm thick; 2 m long; slotted; according to EN 60715; "Hole width 25 mm; silver-colored

www.wago.com/210-112



Item no.: 210-113

Steel carrier rail; 35 x 7.5 mm; 1 mm thick; 2 m long; unslotted; according to EN 60715; silver-colored

www.wago.com/210-113



Item no.: 210-114

Steel carrier rail; 35 x 15 mm; 1.5 mm thick; 2 m long; unslotted; similar to EN 60715; silver-colored

www.wago.com/210-114



Item no.: 210-115

Steel carrier rail; 35 x 7.5 mm; 1 mm thick; 2 m long; slotted; according to EN 60715; "Hole width 18 mm; silver-colored

www.wago.com/210-115



Item no.: 210-118

Steel carrier rail; 35 x 15 mm; 2.3 mm thick; 2 m long; unslotted; according to EN 60715; silver-colored

www.wago.com/210-118



Item no.: 210-196

Aluminum carrier rail; 35 x 8.2 mm; 1.6 mm thick; 2 m long; unslotted; similar to EN 60715; silver-colored

www.wago.com/210-196



Item no.: 210-197

Steel carrier rail; 35 x 15 mm; 1.5 mm thick; 2 m long; slotted; similar to EN 60715; silver-colored

www.wago.com/210-197

Subject to changes. Please also observe the further product documentation!

WAGO Kontakttechnik GmbH & Co. KG

Hansastr. 27















32423 Minden

Phone: +49571 887-0 | Fax: +49571 887-169















Email: info.de@wago.com | Web: www.wago.com

Do you have any questions about our products?

















We are always happy to take your call at +49 (571) 887-44222.

	<p>Item no.: 210-198 Copper carrier rail; 35 x 15 mm; 2.3 mm thick; 2 m long; unslotted; according to EN 60715; copper-colored</p>	www.wago.com/210-198
	<p>Item no.: 210-504 Steel carrier rail; 35 x 7.5 mm; 1 mm thick; 2 m long; slotted; galvanized; according to EN 60715; silver-colored</p>	www.wago.com/210-504
	<p>Item no.: 210-505 Steel carrier rail; 35 x 7.5 mm; 1 mm thick; 2 m long; unslotted; galvanized; according to EN 60715; silver-colored</p>	www.wago.com/210-505
	<p>Item no.: 210-506 Steel carrier rail; 35 x 15 mm; 1.5 mm thick; 2 m long; unslotted; galvanized; similar to EN 60715; silver-colored</p>	www.wago.com/210-506
	<p>Item no.: 210-508 Steel carrier rail; 35 x 15 mm; 1.5 mm thick; 2 m long; slotted; galvanized; similar to EN 60715; silver-colored</p>	www.wago.com/210-508
Jumper		
	<p>Item no.: 2002-400 Continuous jumper; 2-way; insulated; light gray</p>	www.wago.com/2002-400
	<p>Item no.: 2002-402 Jumper; 2-way; insulated; light gray</p>	www.wago.com/2002-402
	<p>Item no.: 2002-402/000-005 Jumper; 2-way; insulated; red</p>	www.wago.com/2002-402/000-005
	<p>Item no.: 2002-402/000-006 Jumper; 2-way; insulated; blue</p>	www.wago.com/2002-402/000-006
	<p>Item no.: 2002-403 Jumper; 3-way; insulated; light gray</p>	www.wago.com/2002-403
	<p>Item no.: 2002-403/000-005 Jumper; 3-way; insulated; red</p>	www.wago.com/2002-403/000-005
	<p>Item no.: 2002-403/000-006 Jumper; 3-way; insulated; blue</p>	www.wago.com/2002-403/000-006
	<p>Item no.: 2002-404 Jumper; 4-way; insulated; light gray</p>	www.wago.com/2002-404
	<p>Item no.: 2002-404/000-005 Jumper; 4-way; insulated; red</p>	www.wago.com/2002-404/000-005
	<p>Item no.: 2002-404/000-006 Jumper; 4-way; insulated; blue</p>	www.wago.com/2002-404/000-006

Subject to changes. Please also observe the further product documentation!

	Item no.: 2002-405 Jumper; 5-way; insulated; light gray	www.wago.com/2002-405
	Item no.: 2002-405/000-005 Jumper; 5-way; insulated; red	www.wago.com/2002-405/000-005
	Item no.: 2002-405/000-006 Jumper; 5-way; insulated; blue	www.wago.com/2002-405/000-006
	Item no.: 2002-405/011-000 Star point jumper; 3-way; insulated; light gray	www.wago.com/2002-405/011-000
	Item no.: 2002-406 Jumper; 6-way; insulated; light gray	www.wago.com/2002-406
	Item no.: 2002-406/000-005 Jumper; 6-way; insulated; red	www.wago.com/2002-406/000-005
	Item no.: 2002-406/000-006 Jumper; 6-way; insulated; blue	www.wago.com/2002-406/000-006
	Item no.: 2002-406/020-000 Delta jumper; insulated; light gray	www.wago.com/2002-406/020-000
	Item no.: 2002-407 Jumper; 7-way; insulated; light gray	www.wago.com/2002-407
	Item no.: 2002-407/000-005 Jumper; 7-way; insulated; red	www.wago.com/2002-407/000-005
	Item no.: 2002-407/000-006 Jumper; 7-way; insulated; blue	www.wago.com/2002-407/000-006
	Item no.: 2002-408 Jumper; 8-way; insulated; light gray	www.wago.com/2002-408
	Item no.: 2002-408/000-005 Jumper; 8-way; insulated; red	www.wago.com/2002-408/000-005
	Item no.: 2002-408/000-006 Jumper; 8-way; insulated; blue	www.wago.com/2002-408/000-006
	Item no.: 2002-409	

Subject to changes. Please also observe the further product documentation!

	Jumper; 9-way; insulated; light gray	www.wago.com/2002-409
	Item no.: 2002-409/000-005 Jumper; 9-way; insulated; red	www.wago.com/2002-409/000-005
	Item no.: 2002-409/000-006 Jumper; 9-way; insulated; blue	www.wago.com/2002-409/000-006
	Item no.: 2002-410 Jumper; 10-way; insulated; light gray	www.wago.com/2002-410
	Item no.: 2002-410/000-005 Jumper; 10-way; insulated; red	www.wago.com/2002-410/000-005
	Item no.: 2002-410/000-006 Jumper; 10-way; insulated; blue	www.wago.com/2002-410/000-006
	Item no.: 2002-423 Continuous jumper; from 1 to 3; insulated; light gray	www.wago.com/2002-423
	Item no.: 2002-423/000-005 Continuous jumper; from 1 to 3; insulated; red	www.wago.com/2002-423/000-005
	Item no.: 2002-423/000-006 Continuous jumper; from 1 to 3; insulated; blue	www.wago.com/2002-423/000-006
	Item no.: 2002-433 Jumper; from 1 to 3; insulated; light gray	www.wago.com/2002-433
	Item no.: 2002-434 Jumper; from 1 to 4; insulated; light gray	www.wago.com/2002-434
	Item no.: 2002-435 Jumper; from 1 to 5; insulated; light gray	www.wago.com/2002-435
	Item no.: 2002-436 Jumper; from 1 to 6; insulated; light gray	www.wago.com/2002-436
	Item no.: 2002-437 Jumper; from 1 to 7; insulated; light gray	www.wago.com/2002-437
	Item no.: 2002-438 Jumper; from 1 to 8; insulated; light gray	www.wago.com/2002-438
	Item no.: 2002-439 Jumper; from 1 to 9; insulated; light gray	www.wago.com/2002-439

Subject to changes. Please also observe the further product documentation!



Item no.: 2002-440
Jumper; from 1 to 10; insulated; light gray

www.wago.com/2002-440



Item no.: 2002-472
Staggered jumper; 2-way; insulated; light gray

www.wago.com/2002-472



Item no.: 2002-473
Staggered jumper; 3-way; insulated; light gray

www.wago.com/2002-473

Item no.: 2002-473/011-000
Staggered jumper; 2-way; from 1 to 3; insulated; light gray

www.wago.com/2002-473/011-000



Item no.: 2002-474
Staggered jumper; 4-way; insulated; light gray

www.wago.com/2002-474



Item no.: 2002-475
Staggered jumper; 5-way; insulated; light gray

www.wago.com/2002-475

Item no.: 2002-475/011-000
Staggered jumper; 3-way; insulated; light gray

www.wago.com/2002-475/011-000



Item no.: 2002-476
Staggered jumper; 6-way; insulated; light gray

www.wago.com/2002-476



Item no.: 2002-477
Staggered jumper; 7-way; insulated; light gray

www.wago.com/2002-477



Item no.: 2002-477/011-000
Staggered jumper; insulated; light gray

www.wago.com/2002-477/011-000



Item no.: 2002-478
Staggered jumper; 8-way; insulated; light gray

www.wago.com/2002-478



Item no.: 2002-479
Staggered jumper; 9-way; insulated; light gray

www.wago.com/2002-479

Item no.: 2002-479/011-000
Staggered jumper; insulated; light gray

www.wago.com/2002-479/011-000



Item no.: 2002-480
Staggered jumper; 10-way; insulated; light gray

www.wago.com/2002-480



Item no.: 2002-481
Staggered jumper; 11-way; insulated; light gray















www.wago.com/2002-481

Item no.: 2002-481/011-000
Staggered jumper; insulated; light gray















www.wago.com/2002-481/011-000

Item no.: 2002-482

Subject to changes. Please also observe the further product documentation!

	Staggered jumper; 12-way; insulated; light gray	www.wago.com/2002-482
	Item no.: 210-103 Wire commoning chain; insulated; black	www.wago.com/210-103
	Item no.: 210-123 Wire commoning chain; insulated; blue	www.wago.com/210-123
Insulation stop		
	Item no.: 2002-171 Insulation stop; 0.25 - 0.5 mm ² ; 5 pieces/strip; light gray	www.wago.com/2002-171
	Item no.: 2002-172 Insulation stop; 0.75 - 1 mm ² ; 5 pieces/strip; dark gray	www.wago.com/2002-172
ferrule		
	Item no.: 216-241 Ferrule; Sleeve for 0.5 mm ² / 20 AWG; insulated; electro-tin plated; electrolytic copper; gastight crimped; acc. to DIN 46228, Part 4/09.90; white	www.wago.com/216-241
	Item no.: 216-242 Ferrule; Sleeve for 0.75 mm ² / 18 AWG; insulated; electro-tin plated; electrolytic copper; gastight crimped; acc. to DIN 46228, Part 4/09.90; gray	www.wago.com/216-242
	Item no.: 216-243 Ferrule; Sleeve for 1 mm ² / AWG 18; insulated; electro-tin plated; electrolytic copper; gastight crimped; acc. to DIN 46228, Part 4/09.90; red	www.wago.com/216-243
	Item no.: 216-244 Ferrule; Sleeve for 1.5 mm ² / AWG 16; insulated; electro-tin plated; electrolytic copper; gastight crimped; acc. to DIN 46228, Part 4/09.90; black	www.wago.com/216-244
	Item no.: 216-246 Ferrule; Sleeve for 2.5 mm ² / AWG 14; insulated; electro-tin plated; electrolytic copper; gastight crimped; acc. to DIN 46228, Part 4/09.90; blue	www.wago.com/216-246
	Item no.: 216-262 Ferrule; Sleeve for 0.75 mm ² / 18 AWG; insulated; electro-tin plated; electrolytic copper; gastight crimped; acc. to DIN 46228, Part 4/09.90; gray	www.wago.com/216-262
	Item no.: 216-263 Ferrule; Sleeve for 1 mm ² / AWG 18; insulated; electro-tin plated; electrolytic copper; gastight crimped; acc. to DIN 46228, Part 4/09.90; red	www.wago.com/216-263
	Item no.: 216-264 Ferrule; Sleeve for 1.5 mm ² / AWG 16; insulated; electro-tin plated; electrolytic copper; gastight crimped; acc. to DIN 46228, Part 4/09.90; black	www.wago.com/216-264
	Item no.: 216-266 Ferrule; Sleeve for 2.5 mm ² / AWG 14; insulated; electro-tin plated; electrolytic copper; gastight crimped; acc. to DIN 46228, Part 4/09.90; blue	www.wago.com/216-266
check		
	Item no.: 2002-511 Modular TOPJOB®S connector; modular; for jumper contact slot; 1-pole; 2,50 mm ² ; gray	www.wago.com/2002-511

Subject to changes. Please also observe the further product documentation!

	Item no.: 2002-549 Spacer module; modular; e.g., for bridging commoned terminal blocks; gray	www.wago.com/2002-549
	Item no.: 2002-552 Modular TOPJOB®S connector; modular; for jumper contact slot; 2-pole; 2,50 mm ² ; gray	www.wago.com/2002-552
	Item no.: 2002-553 Modular TOPJOB®S connector; modular; for jumper contact slot; 3-pole; 2,50 mm ² ; gray	www.wago.com/2002-553
	Item no.: 2002-554 Modular TOPJOB®S connector; modular; for jumper contact slot; 4-pole; 2,50 mm ² ; gray	www.wago.com/2002-554
	Item no.: 2002-555 Modular TOPJOB®S connector; modular; for jumper contact slot; 5-pole; 2,50 mm ² ; gray	www.wago.com/2002-555
	Item no.: 2002-556 Modular TOPJOB®S connector; modular; for jumper contact slot; 6-pole; 2,50 mm ² ; gray	www.wago.com/2002-556
	Item no.: 2002-557 Modular TOPJOB®S connector; modular; for jumper contact slot; 7-pole; 2,50 mm ² ; gray	www.wago.com/2002-557
	Item no.: 2002-558 Modular TOPJOB®S connector; modular; for jumper contact slot; 8-pole; 2,50 mm ² ; gray	www.wago.com/2002-558
	Item no.: 2002-559 Modular TOPJOB®S connector; modular; for jumper contact slot; 9-pole; 2,50 mm ² ; gray	www.wago.com/2002-559
	Item no.: 2002-560 Modular TOPJOB®S connector; modular; for jumper contact slot; 10-pole; 2,50 mm ² ; gray	www.wago.com/2002-560
	Item no.: 2002-611 TOPJOB®S L-type test plug module; modular; 1-pole; 2,50 mm ² ; gray	www.wago.com/2002-611
	Item no.: 2002-649 TOPJOB®S L-type spacer module; modular; e.g., for bridging commoned terminal blocks; gray	www.wago.com/2002-649
	Item no.: 2009-174 Test plug adapter; for 4 mm Ø test plugs; for testing TOPJOB®S rail-mounted terminal blocks; gray	www.wago.com/2009-174
	Item no.: 2009-182 Testing tap; for max. 2.5 mm ² ; tool-free connection for individual test wires 0.08 - 2.5 mm; gray	www.wago.com/2009-182
	Item no.: 210-136 Test plug; 2 mm Ø; with 500 mm cable; red	www.wago.com/210-136

Downloads

Documentation

Additional Information

Technical explanations	3. 4. 2019	pdf 2.2 MB	Download
------------------------	------------	---------------	----------

Subject to changes. Please also observe the further product documentation!

Environmental Product Compliance

Compliance Search

Environmental Product Compliance 2202-1772

URL

Download

3-conductor disconnect/test terminal block; with push-button; with test option; orange disconnect link; for DIN-rail 35 x 15 and 35 x 7.5; 2.5 mm²; Push-in CAGE CLAMP®; 2,50 mm²; orange

Installation Notes

Conductor termination

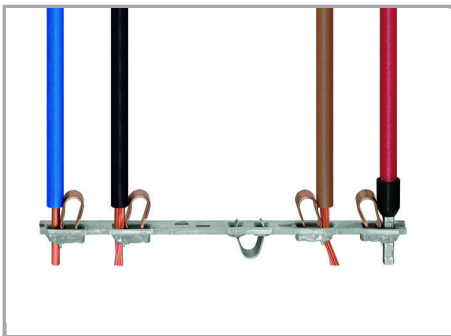

All conductor types at a glance

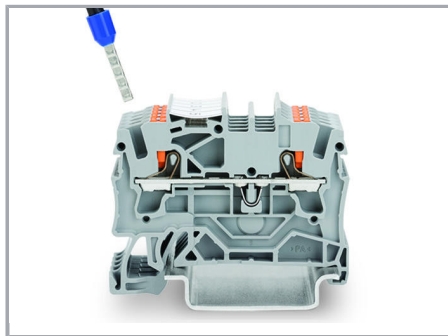

Push-in termination of solid and ferruled conductors

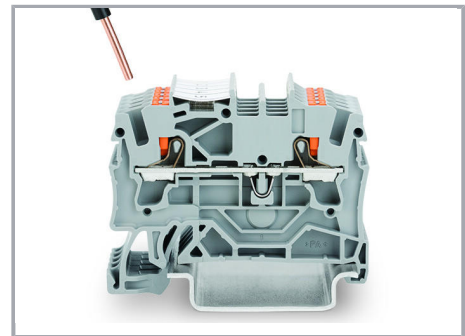

Push-in termination of solid and ferruled conductors



Insert fine-stranded conductors via operating tool.



Removing all conductors via operating tool.

Commoning

Subject to changes. Please also observe the further product documentation!

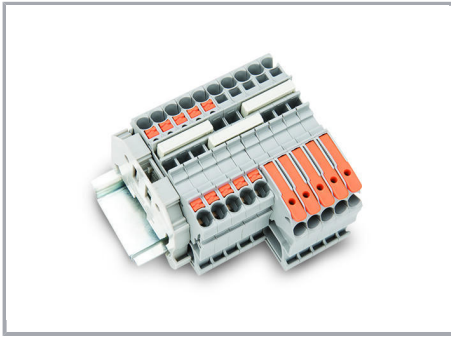

Insert a push-in type jumper bar and push down until it hits the backstop.

Marking

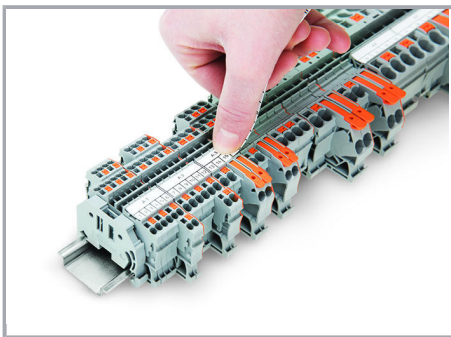

Snapping a marking strip into a marker slot.

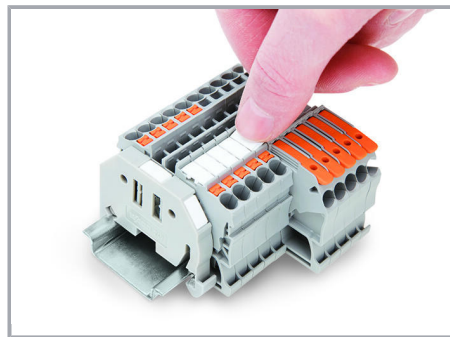

Snapping a marking strip into the marker slot.

Product family

TOPJOB® S

TOPJOB® S: In various industrial applications and modern building installations, WAGO's wide and versatile range of rail-mount terminal blocks provides more than just reliable electrical connections.

[Show all products from the family](#)

Subject to changes. Please also observe the further product documentation!