

Data sheet | Item number: 2042-3004

Relay module; Nominal input voltage: 24 VDC; 1 make contact; Limiting continuous current: 6 A; Path; Green status indicator; Module width: 10 mm

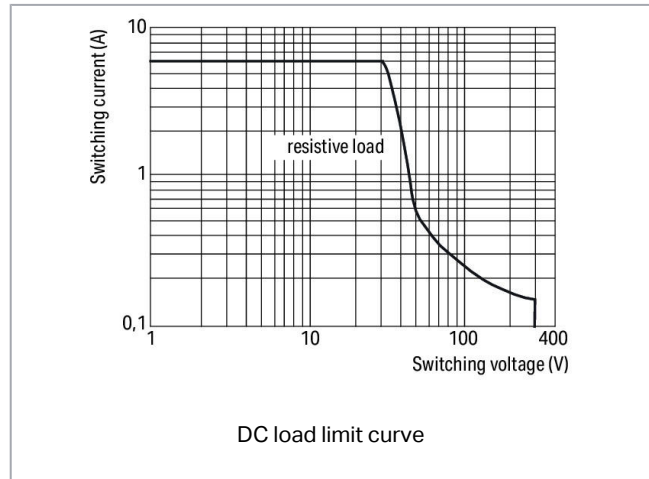

www.wago.com/2042-3004

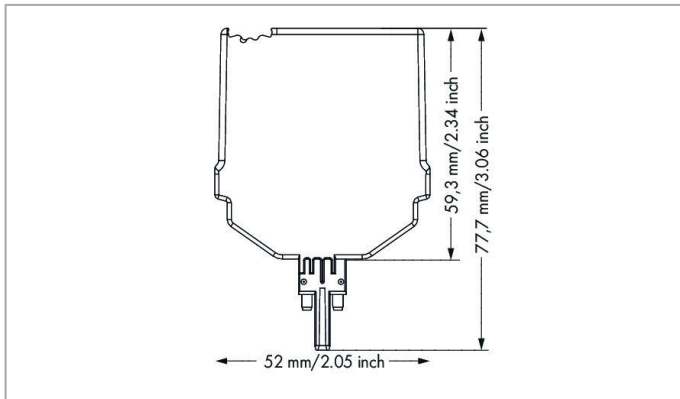
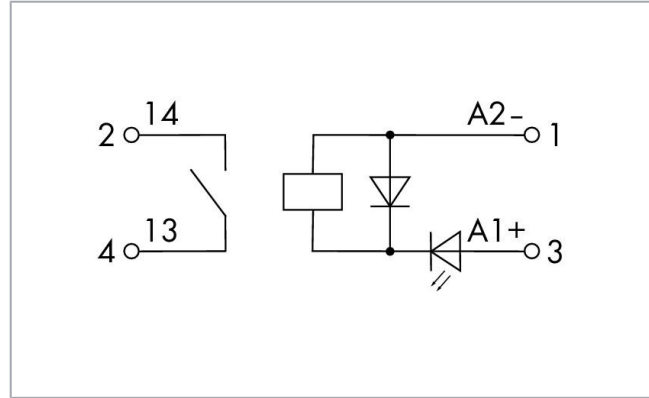
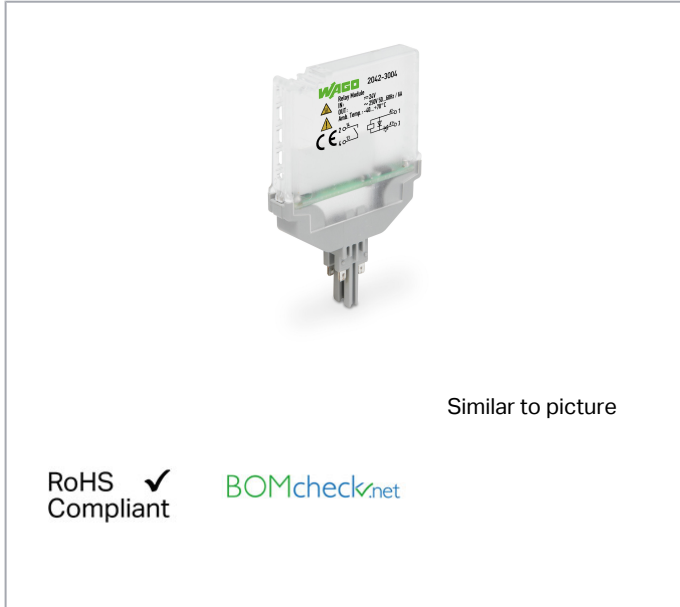

Data

Technical data

Control circuit

Nominal input voltage U_N

DC 24 V

Subject to changes. Please also observe the further product documentation!

WAGO Kontakttechnik GmbH & Co. KG
Hansastr. 27
32423 Minden
Phone: +49571 887-0 | Fax: +49571 887-169
Email: info.de@wago.com | Web: www.wago.com

Do you have any questions about our products?
We are always happy to take your call at +49 (571) 887-44222.



Input voltage range	-30 ... +25 %
Nominal input current at U_N	6.6 mA

Load circuit

Number of make/switch-on contacts	1
Contact material (relay)	AgSnO ₂
Limiting continuous current	6 A
Switching voltage (max.)	AC 250 V
Switching power (resistive) (max.)	AC 1500 VA; DC (see load limit curve)
Switching capacity	AC-15: 3 A / AC 250 V; DC-13: 2 A / DC 24 V
Recommended minimum load	10 V / 10 mA; 24 V / 1 mA
Pull-in time (typ.)	8 ms
Drop-out time (typ.)	4 ms
Electrical life (NO; resistive load; 23 °C)	50 x 10 ³ switching operations
Mechanical life	5 x 10 ⁶ switching operations

Signaling

Status indicator	Green LED
------------------	-----------

Safety and protection

Rated voltage	250 V
Pollution degree	2
Dielectric strength, control/load circuit (AC, 1 min)	3 kVrms
Dielectric strength, open contact (AC, 1 min)	1 kVrms
Protection type	IP20

Physical data

Width	10.3 mm / 0.406 inch
Height	77.7 mm / 3.059 inch
Height from the surface	59.3 mm / 2.335 inch
Depth	52 mm / 2.047 inch

Mechanical data

Mounting type	Pluggable module for TOPJOB® S carrier terminal block
---------------	---

Subject to changes. Please also observe the further product documentation!

Material data

Flammability class per UL94	V0
Weight	20.2 g

Environmental requirements

Surrounding air temperature (operation at U_N)	-40 ... 70 °C
Surrounding air temperature (storage)	-40 ... 85 °C
Processing temperature	-25 ... +50 °C
Operating altitude (max.)	2000 m

Standards and specifications

Standards/Specifications	EN 61010-2-201; EN 61373; EN 50121-3-2
--------------------------	--

Commercial data

Packaging type	BOX
Country of origin	DE
GTIN	4055143709477
Customs tariff number	85364900990



Approvals / Certificates

UL-Approvals

Logo	Approval	Additional Approval Text	Certificate name
	UL Underwriters Laboratories Inc. (ORDINARY LOCATIONS)	UL 61010-1	E175199

Compatible products

End plate

	Item no.: 2002-1691 End and intermediate plate; 1 mm thick; gray	www.wago.com/2002-1691
	Item no.: 2002-1692 End and intermediate plate; 1 mm thick; orange	www.wago.com/2002-1692
	Item no.: 2002-1791 End and intermediate plate; 1 mm thick; gray	www.wago.com/2002-1791

Subject to changes. Please also observe the further product documentation!



Item no.: 2002-1792
End and intermediate plate; 1 mm thick; orange

www.wago.com/2002-1792



Item no.: 2002-1891
End and intermediate plate; 1 mm thick; gray

www.wago.com/2002-1891



Item no.: 2002-1892
End and intermediate plate; 1 mm thick; orange

www.wago.com/2002-1892

clamps



Item no.: 2002-1661
2-conductor carrier terminal block; for DIN-rail 35 x 15 and 35 x 7.5; 2.5 mm²; Push-in CAGE CLAMP®; 2,50 mm²; gray

www.wago.com/2002-1661



Item no.: 2002-1761
3-conductor carrier terminal block; for DIN-rail 35 x 15 and 35 x 7.5; 2.5 mm²; Push-in CAGE CLAMP®; 2,50 mm²; gray

www.wago.com/2002-1761

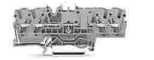

Item no.: 2002-1861
4-conductor carrier terminal block; for DIN-rail 35 x 15 and 35 x 7.5; 2.5 mm²; Push-in CAGE CLAMP®; 2,50 mm²; gray

www.wago.com/2002-1861



Item no.: 2002-1961
2-conductor carrier terminal block; with additional jumper position; for DIN-rail 35 x 15 and 35 x 7.5; 2.5 mm²; Push-in CAGE CLAMP®; 2,50 mm²; gray

www.wago.com/2002-1961

Marking accessories



Item no.: 2009-110
Marking strips; for Smart Printer; on reel; not stretchable; plain; snap-on type; white

www.wago.com/2009-110



Item no.: 2009-115
WMB-Inline; for Smart Printer; 1500 pieces on roll; stretchable 5 - 5.2 mm; plain; snap-on type; white

www.wago.com/2009-115



Item no.: 2009-115/000-002
WMB-Inline; for Smart Printer; 1500 pieces on roll; stretchable 5 - 5.2 mm; plain; snap-on type; yellow

www.wago.com/2009-115/000-002



Item no.: 2009-115/000-006
WMB-Inline; for Smart Printer; 1500 pieces on roll; stretchable 5 - 5.2 mm; plain; snap-on type; blue

www.wago.com/2009-115/000-006



Item no.: 2009-115/000-007
WMB-Inline; for Smart Printer; 1500 pieces on roll; stretchable 5 - 5.2 mm; plain; snap-on type; gray

www.wago.com/2009-115/000-007



Item no.: 2009-115/000-012
WMB-Inline; for Smart Printer; 1500 pieces on roll; stretchable 5 - 5.2 mm; plain; snap-on type; orange















www.wago.com/2009-115/000-012



Item no.: 2009-115/000-017
WMB-Inline; for Smart Printer; 1500 pieces on roll; stretchable 5 - 5.2 mm; plain; snap-on type; light green

www.wago.com/2009-115/000-017

Subject to changes. Please also observe the further product documentation!

	<p>Item no.: 2009-115/000-023 WMB-Inline; for Smart Printer; 1500 pieces on roll; stretchable 5 - 5.2 mm; plain; snap-on type; green</p>	www.wago.com/2009-115/000-023
	<p>Item no.: 2009-115/000-024 WMB-Inline; for Smart Printer; 1500 pieces on roll; stretchable 5 - 5.2 mm; plain; snap-on type; violet</p>	www.wago.com/2009-115/000-024
	<p>Item no.: 793-501 WMB marking card; as card; not stretchable; plain; snap-on type; white</p>	www.wago.com/793-501
	<p>Item no.: 793-501/000-002 WMB marking card; as card; not stretchable; plain; snap-on type; yellow</p>	www.wago.com/793-501/000-002
	<p>Item no.: 793-501/000-005 WMB marking card; as card; not stretchable; plain; snap-on type; red</p>	www.wago.com/793-501/000-005
	<p>Item no.: 793-501/000-006 WMB marking card; as card; not stretchable; plain; snap-on type; blue</p>	www.wago.com/793-501/000-006
	<p>Item no.: 793-501/000-007 WMB marking card; as card; not stretchable; plain; snap-on type; gray</p>	www.wago.com/793-501/000-007
	<p>Item no.: 793-501/000-012 WMB marking card; as card; not stretchable; plain; snap-on type; orange</p>	www.wago.com/793-501/000-012
	<p>Item no.: 793-501/000-017 WMB marking card; as card; not stretchable; plain; snap-on type; light green</p>	www.wago.com/793-501/000-017
	<p>Item no.: 793-501/000-023 WMB marking card; as card; not stretchable; plain; snap-on type; green</p>	www.wago.com/793-501/000-023
	<p>Item no.: 793-501/000-024 WMB marking card; as card; not stretchable; plain; snap-on type; violet</p>	www.wago.com/793-501/000-024
	<p>Item no.: 793-5501 WMB marking card; as card; for terminal block width 5 - 17.5 mm; stretchable 5 - 5.2 mm; plain; snap-on type; white</p>	www.wago.com/793-5501
	<p>Item no.: 793-5501/000-002 WMB marking card; as card; for terminal block width 5 - 17.5 mm; stretchable 5 - 5.2 mm; plain; snap-on type; yellow</p>	www.wago.com/793-5501/000-002
	<p>Item no.: 793-5501/000-005 WMB marking card; as card; for terminal block width 5 - 17.5 mm; stretchable 5 - 5.2 mm; plain; snap-on type; red</p>	www.wago.com/793-5501/000-005

Subject to changes. Please also observe the further product documentation!

**Item no.: 793-5501/000-006**

WMB marking card; as card; for terminal block width 5 - 17.5 mm; stretchable 5 - 5.2 mm; plain; snap-on type; blue

www.wago.com/793-5501/000-006**Item no.: 793-5501/000-007**

WMB marking card; as card; for terminal block width 5 - 17.5 mm; stretchable 5 - 5.2 mm; plain; snap-on type; gray

www.wago.com/793-5501/000-007**Item no.: 793-5501/000-012**

WMB marking card; as card; for terminal block width 5 - 17.5 mm; stretchable 5 - 5.2 mm; plain; snap-on type; orange

www.wago.com/793-5501/000-012**Item no.: 793-5501/000-014**

WMB marking card; as card; for terminal block width 5 - 17.5 mm; stretchable 5 - 5.2 mm; plain; snap-on type; brown

www.wago.com/793-5501/000-014**Item no.: 793-5501/000-017**

WMB marking card; as card; for terminal block width 5 - 17.5 mm; stretchable 5 - 5.2 mm; plain; snap-on type; green

www.wago.com/793-5501/000-017**Item no.: 793-5501/000-023**

WMB marking card; as card; for terminal block width 5 - 17.5 mm; stretchable 5 - 5.2 mm; plain; snap-on type; light green

www.wago.com/793-5501/000-023**Item no.: 793-5501/000-024**

WMB marking card; as card; for terminal block width 5 - 17.5 mm; stretchable 5 - 5.2 mm; plain; snap-on type; violet

www.wago.com/793-5501/000-024**Downloads****Documentation****Bid Text**

2042-3004 X81 - Datei	19. 2. 2019	xml 3.9 kB	Download
--------------------------	-------------	---------------	----------

2042-3004 docx - Datei	20. 2. 2019	docx 16.9 kB	Download
---------------------------	-------------	-----------------	----------

Instruction Leaflet

Pluggable Relay Module / Pluggable Solid-State Relay Module	V 1.1.0	pdf 2.0 MB	Download
---	---------	---------------	----------

Additional Information

Disposal; Electrical and electronic equipment, Packaging	V 1.0.0	pdf 265.8 kB	Download
--	---------	-----------------	----------

Subject to changes. Please also observe the further product documentation!



CAD/CAE-Data

CAD data

2D/3D Models 2042-3004	URL	Download
------------------------	---------------------	--------------------------

CAE data

ZUKEN Portal 2042-3004	URL	Download
------------------------	---------------------	--------------------------

Environmental Product Compliance

Compliance Search

Environmental Product Compliance 2042-3004	URL	Download
--	---------------------	--------------------------

Relay module; Nominal input voltage: 24 VDC; 1 make contact; Limiting continuous current: 6 A; Path; Green status indicator; Module width: 10 mm

Installation Notes

Subject to changes. Please also observe the further product documentation!