

BOXER-6640M

Fanless Embedded Box PC

User's Manual 2nd Ed

Copyright Notice

This document is copyrighted, 2017. All rights are reserved. The original manufacturer reserves the right to make improvements to the products described in this manual at any time without notice.

No part of this manual may be reproduced, copied, translated, or transmitted in any form or by any means without the prior written permission of the original manufacturer. Information provided in this manual is intended to be accurate and reliable. However, the original manufacturer assumes no responsibility for its use, or for any infringements upon the rights of third parties that may result from its use.

The material in this document is for product information only and is subject to change without notice. While reasonable efforts have been made in the preparation of this document to assure its accuracy, AAEMON assumes no liabilities resulting from errors or omissions in this document, or from the use of the information contained herein.

AAEMON reserves the right to make changes in the product design without notice to its users.

Acknowledgement

All other products' name or trademarks are properties of their respective owners.

- Microsoft Windows® is a registered trademark of Microsoft Corp.
- Intel®, Platium®, Celeron®, and Xeon® are registered trademarks of Intel Corporation

All other product names or trademarks are properties of their respective owners.

Packing List

Before setting up your product, please make sure the following items have been shipped:

Item	Quantity
● BOXER-6640M	1
● Wallmount bracket	2
● Screw Package	1
● Thermal Pad	1
● Phoenix power connector	1
● Product DVD with User's Manual (in pdf) and drivers	1

If any of these items are missing or damaged, please contact your distributor or sales representative immediately.

About this Document

This User's Manual contains all the essential information, such as detailed descriptions and explanations on the product's hardware and software features (if any), its specifications, dimensions, jumper/connector settings/definitions, and driver installation instructions (if any), to facilitate users in setting up their product.

Users may refer to the AAEON.com for the latest version of this document.

Safety Precautions

Please read the following safety instructions carefully. It is advised that you keep this manual for future references

1. All cautions and warnings on the device should be noted.
2. Make sure the power source matches the power rating of the device.
3. Position the power cord so that people cannot step on it. Do not place anything over the power cord.
4. Always completely disconnect the power before working on the system's hardware.
5. No connections should be made when the system is powered as a sudden rush of power may damage sensitive electronic components.
6. If the device is not to be used for a long time, disconnect it from the power supply to avoid damage by transient over-voltage.
7. Always disconnect this device from any power supply before cleaning.
8. While cleaning, use a damp cloth instead of liquid or spray detergents.
9. Make sure the device is installed near a power outlet and is easily accessible.
10. Keep this device away from humidity.
11. Place the device on a solid surface during installation to prevent falls.
12. Do not cover the openings on the device to ensure optimal heat dissipation.
13. Watch out for high temperatures when the system is running.
14. Do not touch the heat sink or heat spreader when the system is running
15. Never pour any liquid into the openings. This could cause fire or electric shock.
16. As most electronic components are sensitive to static electrical charge, be sure to ground yourself to prevent static charge when installing the internal components. Use a grounding wrist strap and contain all electronic components in any static-shielded containers.

17. If any of the following situations arises, please contact our service personnel:
 - i. Damaged power cord or plug
 - ii. Liquid intrusion to the device
 - iii. Exposure to moisture
 - iv. Device is not working as expected or in a manner as described in this manual
 - v. The device is dropped or damaged
 - vi. Any obvious signs of damage displayed on the device
18. Do not leave this device in an uncontrolled environment with temperatures beyond the device's permitted storage temperatures (see chapter 1) to prevent damage.
19. Do NOT disassemble the motherboard so as not to damage the system or void your warranty.
20. If the thermal pad had been damaged, please contact AAEON's salesperson to purchase a new one. Do NOT use those of other brands.
21. The Hex Cylinder Coppers on the front panel are not removable.
22. Repeatedly assemble and disassemble the system may cause damages to the exterior paint and surface and screw holes.
23. Use the right size screwdriver.
24. Use the screwdriver correctly to remove screws from the system.

FCC Statement

Warning!



This device complies with Part 15 FCC Rules. Operation is subject to the following two conditions: (1) this device may not cause harmful interference, and (2) this device must accept any interference received including interference that may cause undesired operation.

Caution:

There is a danger of explosion if the battery is incorrectly replaced. Replace only with the same or equivalent type recommended by the manufacturer. Dispose of used batteries according to the manufacturer's instructions and your local government's recycling or disposal directives.

Attention:

Il y a un risque d'explosion si la batterie est remplacée de façon incorrecte. Ne la remplacer qu'avec le même modèle ou équivalent recommandé par le constructeur. Recycler les batteries usées en accord avec les instructions du fabricant et les directives gouvernementales de recyclage.

China RoHS Requirements (CN)

产品中有毒有害物质或元素名称及含量

AAEON Embedded Box PC/ Industrial System

部件名称	有毒有害物质或元素					
	铅 (Pb)	汞 (Hg)	镉 (Cd)	六价铬 (Cr(VI))	多溴联苯 (PBB)	多溴二苯醚 (PBDE)
印刷电路板 及其电子组件	○	○	○	○	○	○
外部信号 连接器及线材	○	○	○	○	○	○
外壳	○	○	○	○	○	○
中央处理器 与内存	○	○	○	○	○	○
硬盘	○	○	○	○	○	○
电源	○	○	○	○	○	○
<p>○: 表示该有毒有害物质在该部件所有均质材料中的含量均在 SJ/T 11363-2006 标准规定的限量要求以下。</p> <p>X: 表示该有毒有害物质至少在该部件的某一均质材料中的含量超出 SJ/T 11363-2006 标准规定的限量要求。</p> <p>备注: 一、此产品所标示之环保使用期限, 系指在一般正常使用状况下。 二、上述部件物质中央处理器、内存、硬盘、电源为选购品。</p>						

China RoHS Requirement (EN)

Poisonous or Hazardous Substances or Elements in Products
 AAEON Embedded Box PC/ Industrial System

Component	Poisonous or Hazardous Substances or Elements					
	Lead (Pb)	Mercury (Hg)	Cadmium (Cd)	Hexavalent Chromium (Cr(VI))	Polybrominated Biphenyls (PBB)	Polybrominated Diphenyl Ethers (PBDE)
PCB & Other Components	○	○	○	○	○	○
Wires & Connectors for External Connections	○	○	○	○	○	○
Chassis	○	○	○	○	○	○
CPU & RAM	○	○	○	○	○	○
Hard Disk	○	○	○	○	○	○
PSU	○	○	○	○	○	○

O: The quantity of poisonous or hazardous substances or elements found in each of the component's parts is below the SJ/T 11363-2006-stipulated requirement.

X: The quantity of poisonous or hazardous substances or elements found in at least one of the component's parts is beyond the SJ/T 11363-2006-stipulated requirement.

Note: The Environment Friendly Use Period as labeled on this product is applicable under normal usage only

Table of Contents

Chapter 1 - Product Specifications	1
1.1 Specifications.....	2
Chapter 2 – Hardware Information	5
2.1 Dimensions	6
2.1.1 I/O Location	9
2.2 Jumpers and Connectors	10
2.3 List of Jumpers	11
2.3.1 Setting Jumpers	11
2.4 List of Connectors	12
2.4.1 Clear CMOS (JP24).....	14
2.4.2 Auto Power Button (JP19).....	14
2.4.3 (PCIE1/ PCIE2) Mini Card Connector With on board SIM	15
2.4.4 (SATA1) SATA Port.....	16
2.4.5 (PWR1) SATA PWR Port.....	17
2.4.6 LAN + USB 3.0 (CN14/ CN15/ CN16).....	17
2.4.7 VGA port.....	18
2.4.8 DC-IN (CN2)	19
2.4.9 HDMI port (CN3/ CN4)	19
2.4.10 Remote switch connector(CN20)	20
2.4.11 COM Port (CN30)	21
2.5 CPU Installation.....	22
2.6 DDR4 Memory Module Installation.....	23
2.7 2.5" SATA Drive Installation.....	25
Chapter 3 - AMI BIOS Setup.....	26
3.1 System Test and Initialization	27
3.2 AMI BIOS Setup.....	28

3.3	Setup Submenu: Main.....	29
3.4	Setup Submenu: Advanced	30
3.4.1	Advanced: CPU Configuration.....	31
3.4.2	Advanced: Trusted Computing.....	32
3.4.3	Advanced: SATA Configuration	33
3.4.4	Advanced: PCH-FW Configuration	34
3.4.5	Advanced: SIO Configuration.....	36
3.4.5.1	SIO Configuration: Serial Port Configuration	37
3.4.6	Advanced: Hardware Monitor	38
3.4.7	Advanced: USB Configuration.....	39
3.4.8	Advanced: Power Management.....	40
3.5	Setup submenu: Chipset.....	41
3.5.1	Chipset: System Agent (SA) Configuration	42
3.5.1.1	System Agent (SA) Configuration: Graphics Configuration	43
3.5.2	Chipset: PCH-IO Configuration.....	44
3.6	Setup submenu: Security	45
3.7	Setup submenu: Boot.....	46
3.8	Setup submenu: Save & Exit.....	47
Chapter 4 – Drivers Installation		48
4.1	Product CD/DVD.....	49
Appendix A - Watchdog Timer Programming.....		51
A.1	Watchdog Timer Initial Program.....	52
Appendix B - I/O Information.....		57
B.1	I/O Address Map.....	58
B.2	Memory Address Map.....	60
B.3	IRQ Mapping Chart	62

Chapter 1

Product Specifications

1.1 Specifications

System

- **Processor**

7th Generation Intel® Core™ Processor family, TDP 35W:
Intel® Core™ i7-7700T, 2.9 GHz
Intel® Core™ i5-7500T, 2.8 GHz
Intel® Core™ i3-7101TE, 3.4 GHz
Intel® Pentium® G4560T, 2.9 GHz

6th Generation Intel® Core™ Processor family, TDP 35W:
Intel® Core™ i7-6700TE, 2.4 GHz
Intel® Core™ i5-6500TE, 2.3 GHz
Intel® Core™ i3-6100TE, 2.7 GHz
Intel® Pentium® G4500T, 3.0 GHz
Intel® Pentium® G4400TE, 2.9 GHz

*Note: For additional CPU support, please contact your local sales representative
- **System Memory**

DDR4 1866/2133 SODIMM slot x 2, up to 32 GB, ECC or Non-ECC support
- **Display**

VGA x 1
HDMI x 2
- **Ethernet**

Intel® I210, 10/100/1000Base-TX x 9
- **Storage Device**

HDD
SSD
mSATA (optional)
2.5" Drive bay x 1
- **Serial Port**

Isolated RS-232/422/485 x 1
- **USB**

USB 3.0 x 8

	USB 2.0 x 2
● Remote I/O	2-Pin Remote Power On/Off Connector
● LED Indicator	Power LED x 1 Hard Disk Active LED x 1
● Expansion Slot	Full-size Mini-Card x 2 SIM Slot x 1 (for PCIe1)
● OS Support	7th Generation Intel® Core™ Processor family: Windows 10 IOT (64bit) Ubuntu 16.04 above Fedora 25 above CentOS 7.3 above
	6th Generation Intel® Core™ Processor family: Windows 10 IOT (64bit) Windows 8.1 (64bit) Windows embedded 8 standard (64bit) Windows 7 (32bit/64bit) Windows embedded standard 7 (32/64bit) Ubuntu 16.04 above Fedora 25 above CentOS 7.3 above

Mechanical

● Construction	Rugged aluminum extrusion and heavy-duty steel
● Mounting	Wallmount
● Dimension (W x H x D)	264.2 mm x 186.2 mm x 96.4 mm (10.4" x 3.8" x 6.1")

- **Gross Weight** 5.9 kg (13.0 lb)
- **Net Weight** 4.5 kg (8.8 lb)

Environmental

- **Operating Temperature** Ambient with Airflow
-20°C ~ 50°C (according to IEC68-2-14 with 0.5 m/s AirFlow ; with industrial devices)
- **Storage Temperature** -45°C ~ 70°C (-49°F ~ 185°F)
- **Storage Humidity** 5~95% @ 40°C, non-condensing
- **Anti-Vibration** 2 Grms/5~500Hz/ operation – SSD/CFast™
1 Grms/5~500Hz/ operation – HDD
- **EMC** CE/FCC Class A

Power Supply

- **DC Input** 9 – 36V with 3-pin terminal block

Chapter 2

Hardware Information

2.1 Dimensions

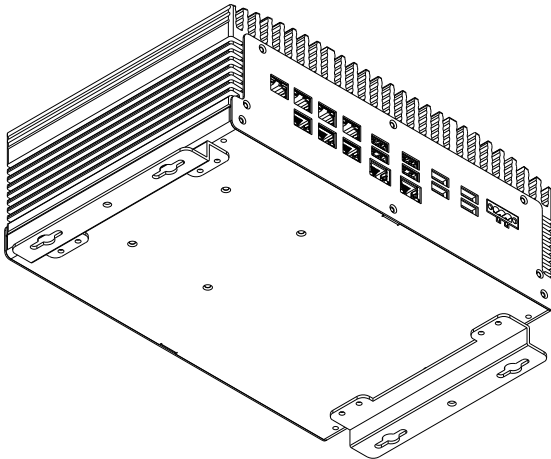
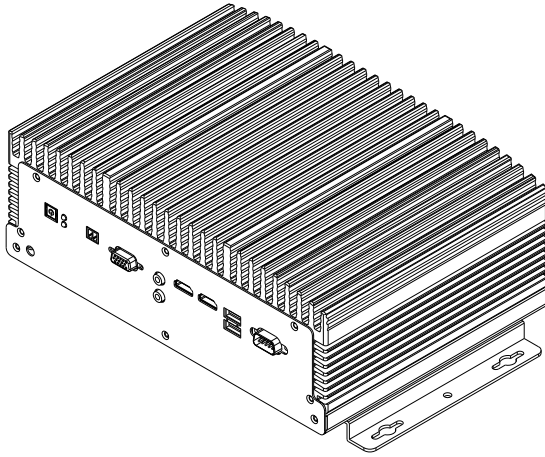

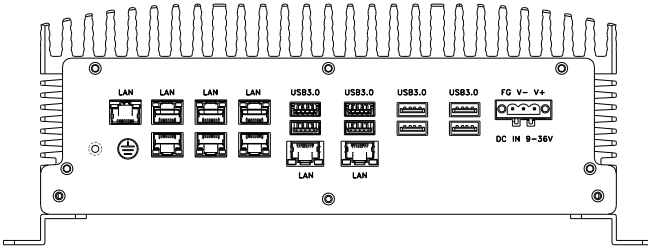
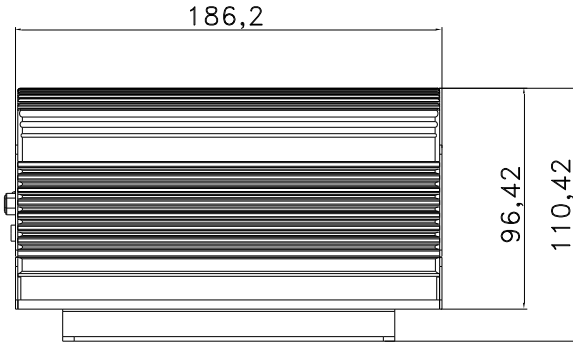

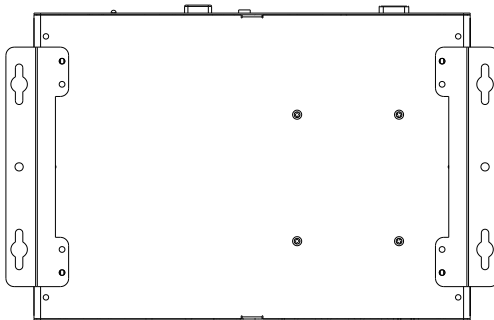
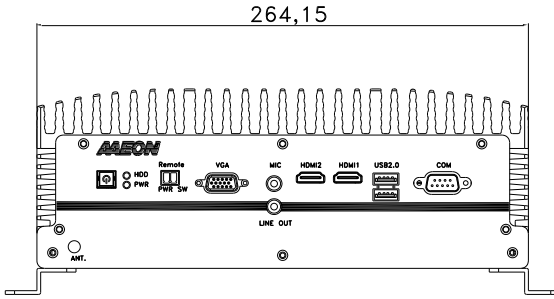

2.1.1 I/O Location

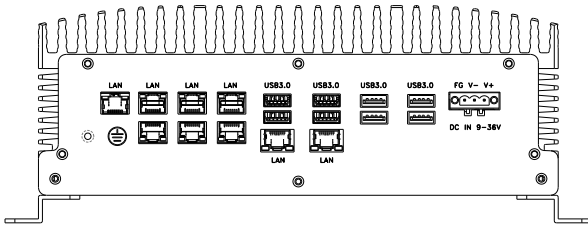
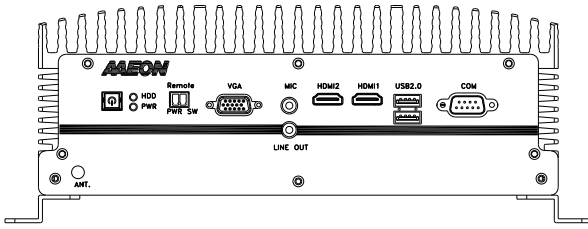

2.2 Jumpers and Connectors

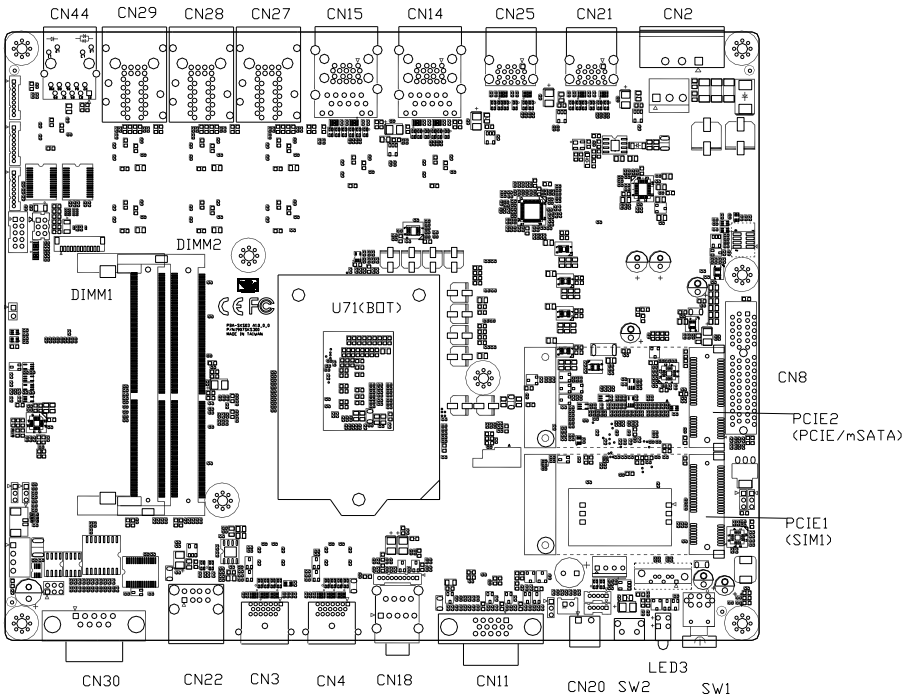

2.3 List of Jumpers

Please refer to the table below for all of the system's jumpers that you can configure for your application.

Label	Function
JP19	AT/ATX mode select
JP24	Clear CMOS

2.3.1 Setting Jumpers

You configure your card to match the needs of your application by setting jumpers. A jumper is the simplest kind of electric switch. It consists of two metal pins and a small metal clip (often protected by a plastic cover) that slides over the pins to connect them. To "close" a jumper you connect the pins with the clip.

To "open" a jumper you remove the clip. Sometimes a jumper will have three pins, labeled 1, 2 and 3. In this case you would connect either pins 1 and 2 or 2 and 3.

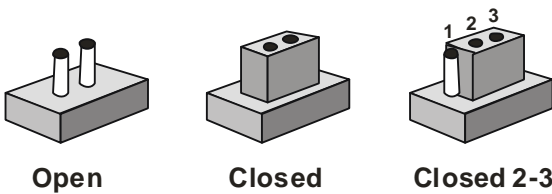

A pair of needle-nose pliers may be helpful when working with jumpers.

If you have any doubts about the best hardware configuration for your application, contact your local distributor or sales representative before you make any change.

Generally, you simply need a standard cable to make most connections.

2.4 List of Connectors

Please refer to the table below for all of the system's connectors that you can configure for your application

Label	Function
CN1	CRT port
CN2	DC-IN
CN3	HDMI1connector
CN4	HDMI2 connector
CN7	SPI ROM connector
CN14	Dual stack USB (3.0/2.0) + LAN
CN15	Dual stack USB (3.0/2.0) + LAN
CN20	Remote button cable connector
CN21	Dual stack USB (3.0/2.0) connector
CN22	Dual stack USB 2.0 Connector
CN24	DC-IN connector (for cable type)
CN25	Dual stack USB (3.0/2.0) connector
CN27	Dual stack LAN
CN28	Dual stack LAN
CN29	Dual stack LAN
CN30	COM Port (RS232/422/485)
CN36	Power button connector (BOX connector)
CN44	LAN connector
CN45, CN46	USB connector (BOX connector for backup)
PWR1	SATA PWR connector
SATA1	SATA connector
BAT1	RTC battery connector
LPC1	Debug port connector

PCIE1	Minicard connector
PCIE2	Minicard connector
SIM1	SIM card connector

2.4.1 Clear CMOS (JP24)

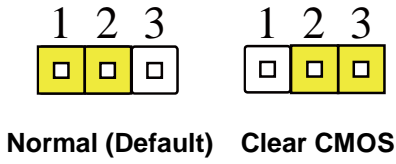

JP1	Function
1-2	Normal (Default)
2-3	Clear CMOS

2.4.2 Auto Power Button (JP19)

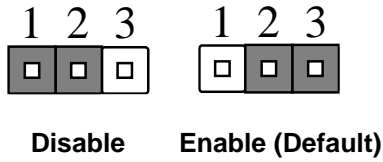

JP3	Function
1-2	ATX (Default)
2-3	AT

2.4.3 (PCIE1/ PCIE2) Mini Card Connector With on board SIM

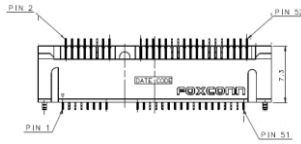

Pin	Signal	Pin	Signal
1	PCIE_WAKE#	2	+V3.3A
3	NC	4	GND
5	NC	6	+1.5V
7	PCIE_CLK_REQ#	8	UIM_PWR
9	GND	10	UIM_DATA
11	PCIE_REF_CLK-	12	UIM_CLK
13	PCIE_REF_CLK+	14	UIM_RST
15	GND	16	UIM_VPP
17	NC	18	GND
19	NC	20	W_DISABLE#
21	GND	22	PCIE_RST#
23	PCIE_RX-	24	+V3.3A
25	PCIE_RX+	26	GND
27	GND	28	+1.5V
29	GND	30	SMB_CLK
31	PCIE_TX-	32	SMB_DATA
33	PCIE_TX+	34	GND
35	GND	36	USB_D-
37	GND	38	USB_D+
39	+V3.3A	40	GND

Pin	Signal	Pin	Signal
41	+V3.3A	42	NC
43	GND	44	NC
45	NC	46	NC
47	NC	48	+1.5V
49	NC	50	GND
51	NC	52	+V3.3A

2.4.4 (SATA1) SATA Port

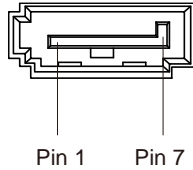

Pin	Signal	Pin	Signal
1	GND	GND	
2	SATA_TX+	DIFF	
3	SATA_TX-	DIFF	
4	GND	GND	
5	SATA_RX-	DIFF	
6	SATA_RX+	DIFF	
7	GND	GND	

2.4.5 (PWR1) SATA PWR Port

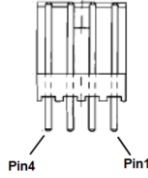

Pin	Pin Name	Level
1	+12V	12V
2	GND	GND
3	GND	GND
4	+5V	5V

2.4.6 LAN + USB 3.0 (CN14/ CN15/ CN16)

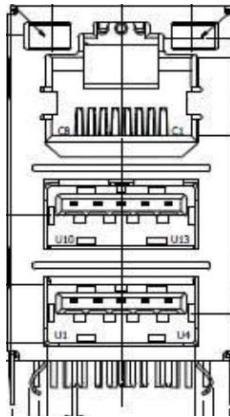

Pin	Signal	Pin	Signal
C1	MDIO+	U2	MDIO-

Pin	Signal	Pin	Signal
C3	MDI1+	U4	MDI2+
C5	MDI2-	U6	MDI1-
C7	MDI3+	U8	MDI3-
U1	VBUS_1	U10	VBUS_2
U2	(A)D-	U11	(B)D-
U3	(A)D+	U12	(B)D+
U4	GND	U13	GND
U5	(A)SSRX-	U14	(B)SSRX-
U6	(A)SSRX+	U15	(B)SSRX+
U7	GND	U16	GND
U8	(A)SSTX-	U17	(B)SSTX-
U9	(A)SSTX+	U18	(B)SSTX+

2.4.7 VGA port

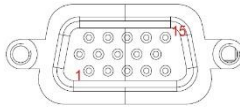

Pin	Signal	Pin	Signal
1	Red	2	Green
3	Blue	4	NC
5	GND	6	GND
7	GND	8	GND
9	VGA_VCC	10	GND
11	NC	12	DDC_DATA
13	VGA_HSYNC	14	VGA_VSYNC

Pin	Signal	Pin	Signal
15	DDC_CLK		

2.4.8 DC-IN (CN2)

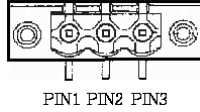

Pin	Signal	Pin	Signal
1	PWR_IN	2	GND
3	NC		

2.4.9 HDMI port (CN3/ CN4)

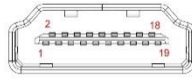

Pin	Signal	Pin	Signal
1	HDMI_DATA2_P	2	GND
3	HDMI_DATA2_N	4	HDMI_DATA1_P
5	GND	6	HDMI_DATA1_N
7	HDMI_DATA0_P	8	GND
9	HDMI_DATA0_N	10	HDMI_CLK_P
11	GND	12	HDMI_CLK_N
13	NC	14	NC
15	HDMI_SCL	16	HDMI_SDA
17	GND	18	HDMI_PWR
19	HDMI_HDP		

2.4.10 Remote switch connector(CN20)

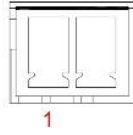

Pin	Pin Name	Pin	Pin Name
1	PANSWH#	2	GND

2.4.11 COM Port (CN30)

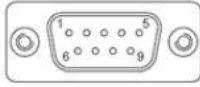

Pin	RS-232	RS422	RS-485
1	DCD	TX-	DATA-
2	RXD	RX+	
3	TXD	TX+	DATA+
4	DTR	RX-	NC
5	GND	NC	NC
6	DSR	NC	NC
7	RTS	NC	NC
8	CTS	NC	NC
9	RI	NC	NC

2.5 CPU Installation

Step 1: Turn off the system, unplug the power cord and make sure the system is off.

Step 2: Have Intel KabyLake FCLGA1151 Processor (Max. TDP 35W) ready.



Step 3: Install the CPU into the socket and place the thermal pad onto it.

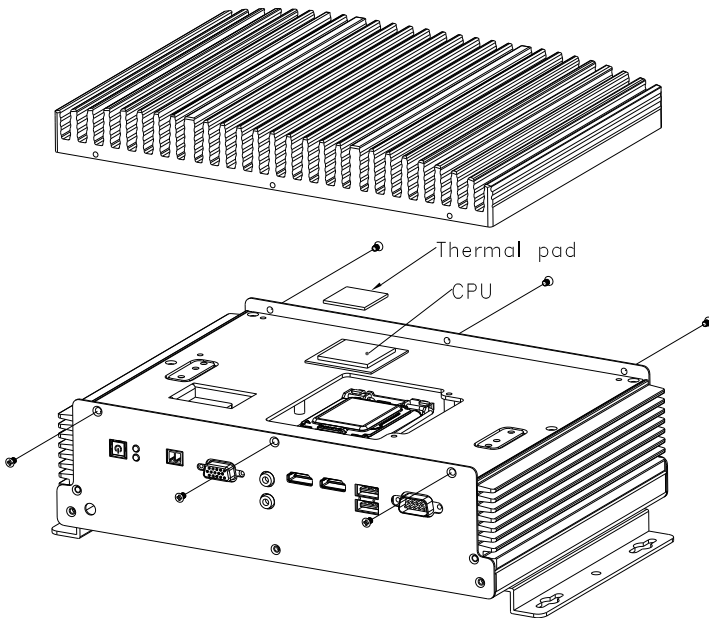

2.6 DDR4 Memory Module Installation

- Turn off the system, unplug the power cord to make sure the system is powered off.

Step 1: Remove the screws as instructed below and remove the heatsink.

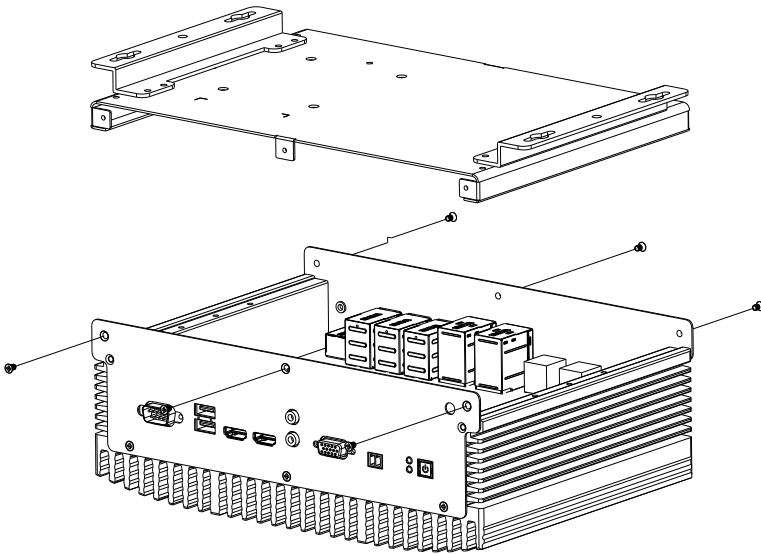

Step 2: Place the thermal pads onto the RAM modules as instructed below.

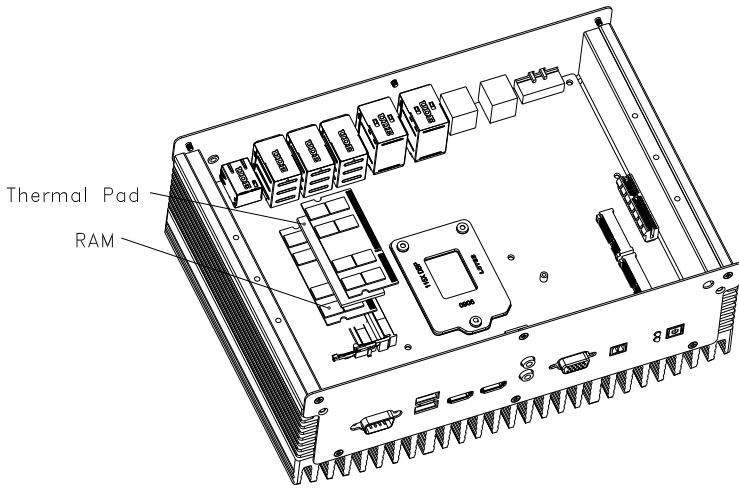

2.7 2.5" SATA Drive Installation

Turn off the system, unplug the power cord to make sure the system is powered off.
Use the HDD screws provided to assemble 2.5" SATA drive with the HDD Bracket.

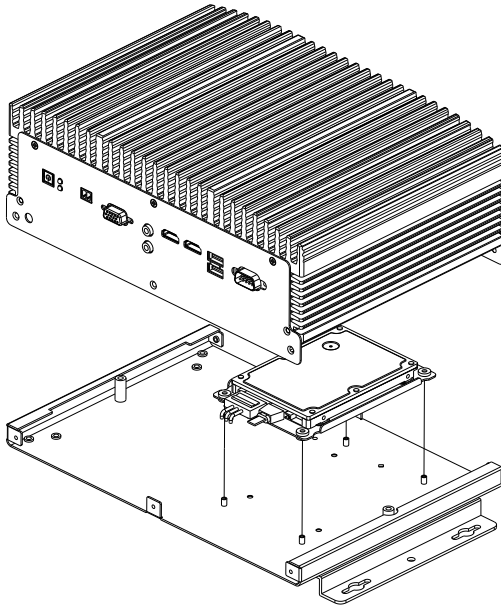

Chapter 3

AMI BIOS Setup

3.1 System Test and Initialization

The system uses certain routines to perform testing and initialization. If an error, fatal or non-fatal, is encountered, a few short beeps or an error message will be outputted. The board can usually continue the boot up sequence with non-fatal errors.

The system configuration verification routines check the current system configuration against the values stored in the CMOS memory. If they do not match, an error message will be outputted, in which case you will need to run the BIOS setup program to set the configuration information in memory.

There are three situations in which you will need to change the CMOS settings:

- You are starting your system for the first time
- You have changed your system's hardware
- The CMOS memory has lost power and the configuration information is erased

The system's CMOS memory uses a backup battery for data retention, which is to be replaced once emptied.

3.2 AMI BIOS Setup

The AMI BIOS ROM has a pre-installed Setup program that allows users to modify basic system configurations, which is stored in the battery-backed CMOS RAM and BIOS NVRAM so that the information is retained when the power is turned off.

To enter BIOS Setup, press immediately while your computer is powering up.

The function for each interface can be found below.

Main – Date and time can be set here. Press <Tab> to switch between date elements

Advanced – Enable/ Disable boot option for legacy network devices

Chipset – For hosting bridge parameters

Boot – Enable/ Disable quiet Boot Option

Security – The setup administrator password can be set here

Save & Exit – Save your changes and exit the program

3.3 Setup Submenu: Main

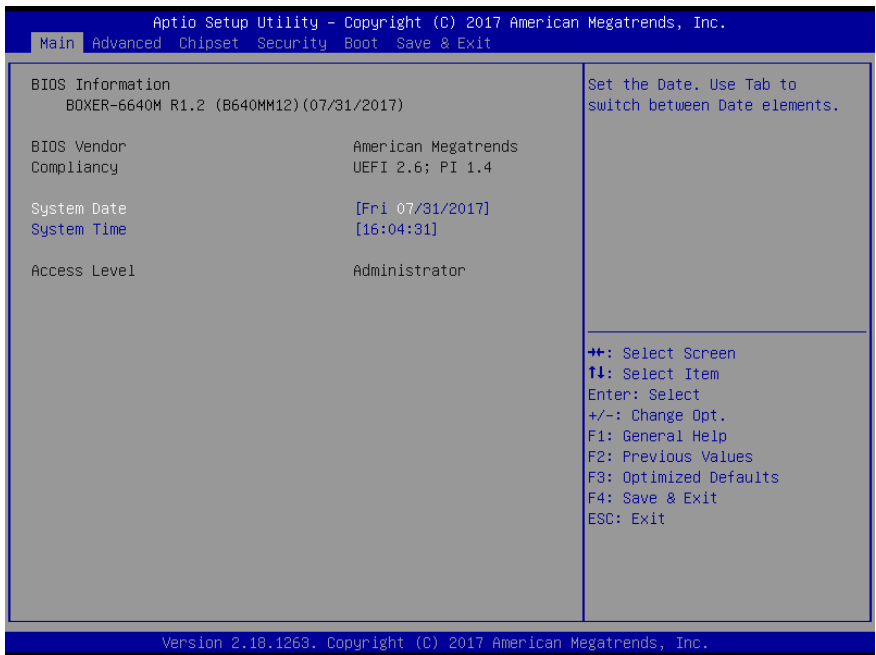

3.4 Setup Submenu: Advanced

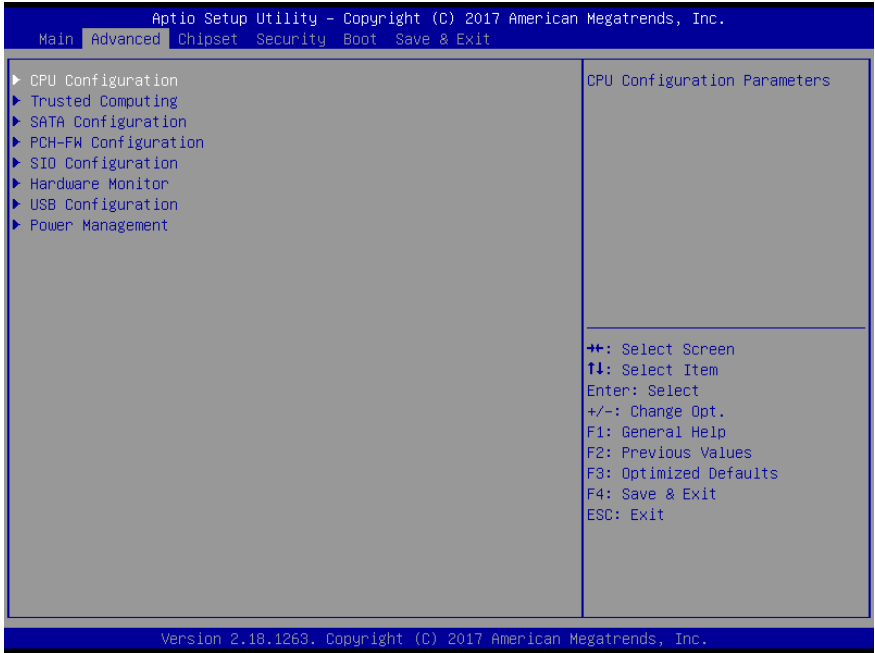

3.4.1 Advanced: CPU Configuration

Aptio Setup Utility - Copyright (C) 2017 American Megatrends, Inc.

Advanced

CPU Configuration		Enabled for Windows XP and Linux (OS optimized for Hyper-Threading Technology) and Disabled for other OS (OS not optimized for Hyper-Threading Technology).
Type	Intel(R) Core(TM) i3-6100TE CPU @ 2.70GHz	
ID	0x506E3	
Speed	2700 MHz	
L1 Data Cache	32 KB x 2	
L1 Instruction Cache	32 KB x 2	
L2 Cache	256 KB x 2	
L3 Cache	4 MB	
L4 Cache	N/A	
VMX	Supported	
SMX/TXT	Not Supported	
Hyper-Threading	[Enabled]	
Intel (VMX) Virtualization Technology	[Enabled]	
Active Processor Cores	[All]	

++: Select Screen
 T1: Select Item
 Enter: Select
 +/-: Change Opt.
 F1: General Help
 F2: Previous Values
 F3: Optimized Defaults
 F4: Save & Exit
 ESC: Exit

Version 2.18.1263. Copyright (C) 2017 American Megatrends, Inc.

Options summary:

Hyper-Threading	Disabled	
	Enabled	Optimal Default, Failsafe Default
Enabled for Windows XP and Linux (OS optimized for Hyper-Threading Technology) and Disabled for other OS (OS not optimized for Hyper-Threading Technology). When Disabled only one thread per enabled core is enabled.		
Intel Virtualization Technology	Disabled	
	Enabled	Optimal Default, Failsafe Default
When enabled, a VMM can utilize the additional hardware capabilities provided by Vander pool Technology		
Active Processor Cores	All	Optimal Default, Failsafe Default
	1	
Number of cores to enable in each processor package.		

3.4.2 Advanced: Trusted Computing



Options summary:

Security Device Support	Enable	Optimal Default, Failsafe Default
	Disable	
Enable or Disable SATA BIOS support for security device. O.S. will not show Security Device. TCG EFI protocol and INT1A interface will not be available.		

3.4.3 Advanced: SATA Configuration

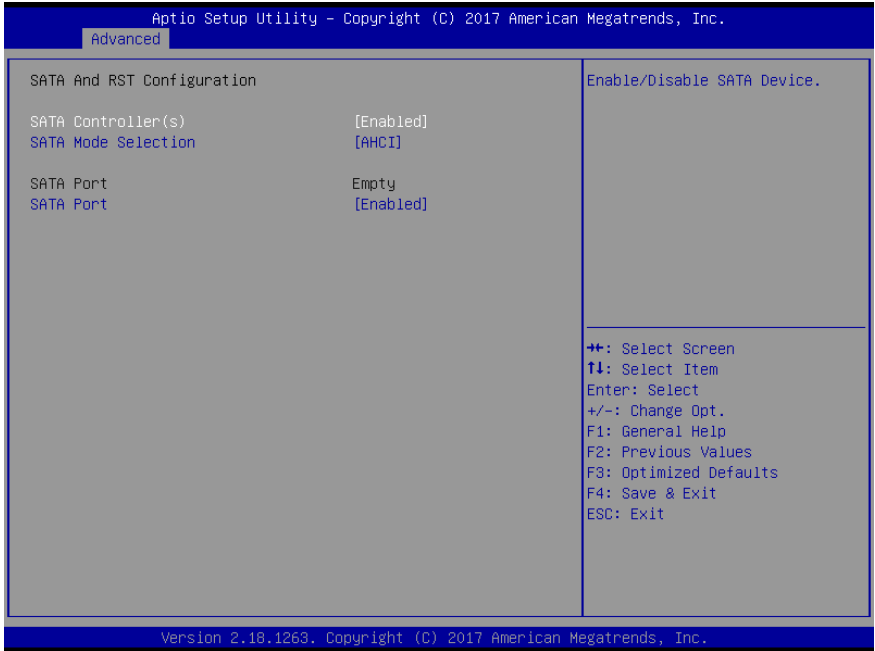

Options summary:

SATA Controller(s)	Enabled	Optimal Default, Failsafe Default
	Disabled	
Enable or Disable SATA Device.		
SATA Mode Selection	IDE Mode	
	AHCI Mode	Optimal Default, Failsafe Default
Determines how SATA controller(s) operate.		
SATA Port	Enabled	Optimal Default, Failsafe Default
	Disabled	
Enable or Disable SATA Port.		

3.4.4 Advanced: PCH-FW Configuration

Aptio Setup Utility - Copyright (C) 2017 American Megatrends, Inc.

Advanced

ME Firmware Version	11.6.25.1229	Configure Management Engine Technology Parameters
ME Firmware Mode	Normal Mode	
ME Firmware SKU	Corporate SKU	

► Firmware Update Configuration

++: Select Screen
↑↓: Select Item
Enter: Select
+/-: Change Opt.
F1: General Help
F2: Previous Values
F3: Optimized Defaults
F4: Save & Exit
ESC: Exit

Version 2.18.1263. Copyright (C) 2017 American Megatrends, Inc.

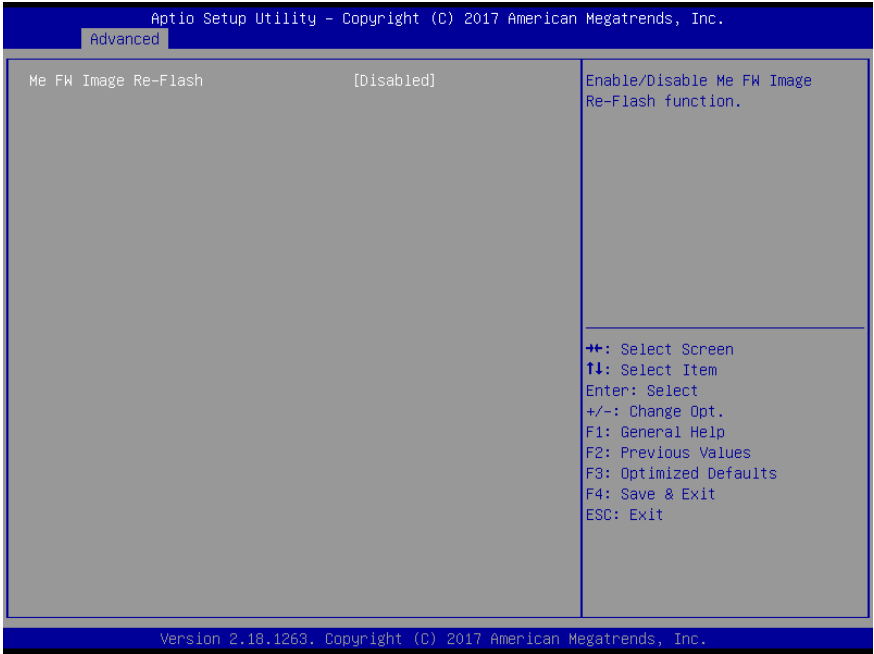

Options summary:

ME FW Image Re-Flash	Enabled	Optimal Default, Failsafe Default
	Disabled	
Enable or Disable ME FW Image Re-Flash function.		

3.4.5 Advanced: SIO Configuration

The screenshot displays the 'Advanced' menu of the AMI Aptio Setup Utility. The title bar reads 'Aptio Setup Utility - Copyright (C) 2017 American Megatrends, Inc.' and the sub-menu is 'Advanced'. The main content area is split into two columns. The left column shows 'AMI SIO Driver Version : A5.07.03', 'Super IO Chip Logical Device(s) Configuration', and a selected option '[*Active*] Serial Port'. Below this is a warning message: 'WARNING: Logical Devices state on the left side of the control, reflects the current Logical Device state. Changes made during Setup Session will be shown after you restart the system.' The right column contains a description: 'View and Set Basic properties of the SIO Logical device. Like IO Base, IRQ Range, DMA Channel and Device Mode.' At the bottom of the right column is a legend for navigation keys: '++: Select Screen', '↑: Select Item', 'Enter: Select', '+/-: Change Opt.', 'F1: General Help', 'F2: Previous Values', 'F3: Optimized Defaults', 'F4: Save & Exit', and 'ESC: Exit'. The footer of the screen reads 'Version 2.18.1263. Copyright (C) 2017 American Megatrends, Inc.'

3.4.5.1 SIO Configuration: Serial Port Configuration

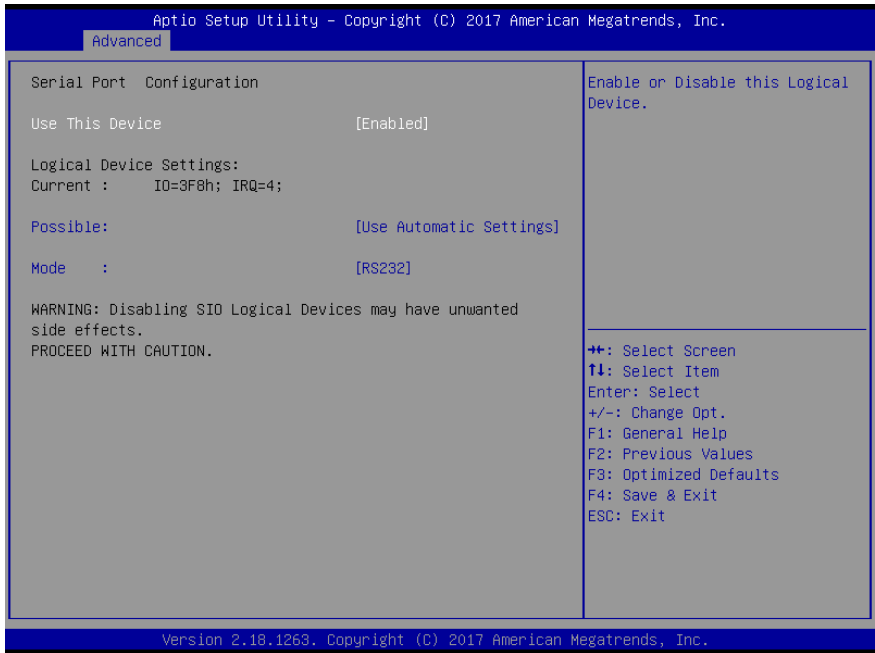

Options summary:

Use This Device	Disabled	Optimal Default, Failsafe Default
	Enabled	
Enable or Disable this Logical Device.		
Possible:	Use Automatic Settings	Optimal Default, Failsafe Default
	IO=2F8; IRQ=3;	
	IO=3F8; IRQ=4;	
Allows user to change Device's Resource settings. New settings will be reflected on This Setup Page after System restarts.		
Mode:	RS232	Optimal Default, Failsafe Default
	RS422	
	RS485	
UART RS232, 422, 485 selection		

3.4.6 Advanced: Hardware Monitor

Aptio Setup Utility - Copyright (C) 2017 American Megatrends, Inc.

Advanced

Pc Health Status

CPU Temperature	: +38 %
System Temperature	: +34 %
VCCORE	: +0.984 V
VMEM	: +1.224 V
+5V	: +5.045 V
+12V	: +12.056 V
+3.3V	: +3.360 V
3VSB	: +3.360 V
5VSB	: +5.064 V
VBAT	: +3.168 V

++: Select Screen
↑↓: Select Item
Enter: Select
+/-: Change Opt.
F1: General Help
F2: Previous Values
F3: Optimized Defaults
F4: Save & Exit
ESC: Exit

Version 2.18.1263. Copyright (C) 2017 American Megatrends, Inc.

3.4.7 Advanced: USB Configuration

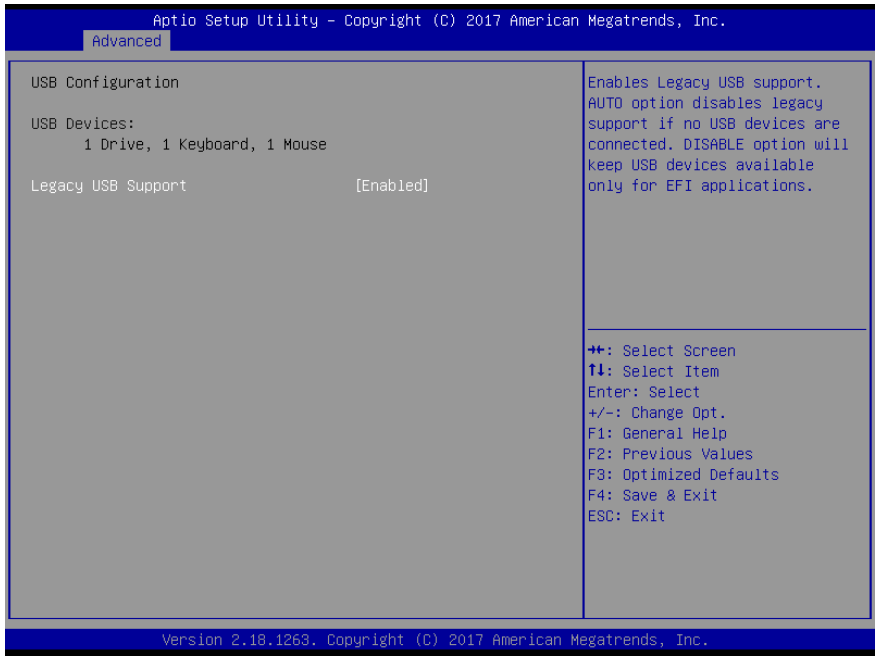

Options summary:

Legacy USB Support	Enabled	Optimal Default, Failsafe Default
	Disabled	
	Auto	
Enables Legacy USB support. AUTO option disables legacy support if no USB devices are connected. DISABLE option will keep USB devices available only for EFI applications.		

3.4.8 Advanced: Power Management

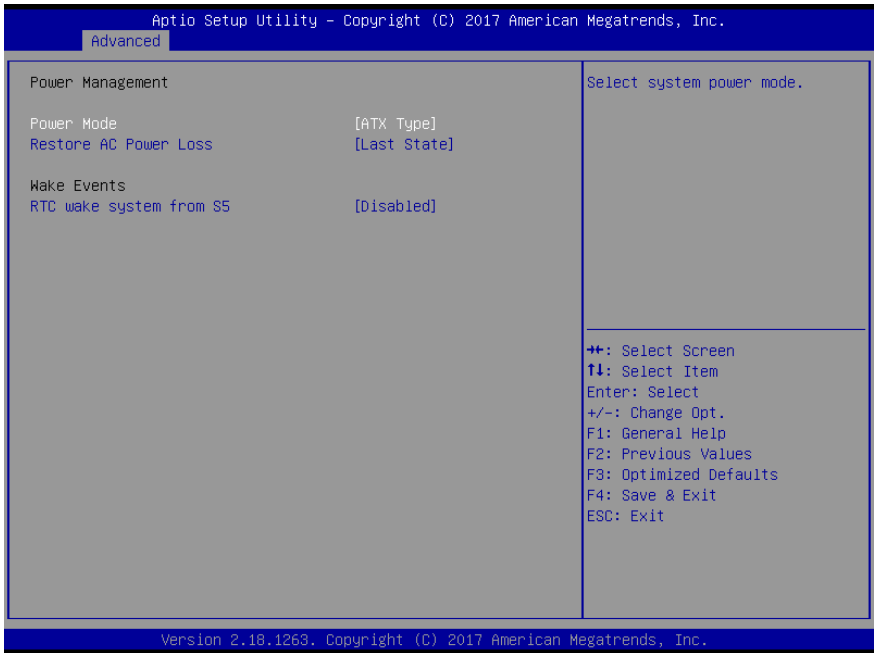

Options summary:

Power Mode	ATX Type	Optimal Default, Failsafe Default
	AT Type	
Select power supply mode.		
Restore AC Power Loss	Last State	Optimal Default, Failsafe Default
	Power On	
	Power Off	
Select power state when power is re-applied after a power failure.		
RTC wake system from S5	Disabled	Optimal Default, Failsafe Default
	Fixed Time	
	Dynamic Time	
Fixed Time: System will wake on the hr::min::sec specified./n Dynamic Time: System will wake on the current time + Increase minute(s)		

3.5 Setup submenu: Chipset



3.5.1 Chipset: System Agent (SA) Configuration

The screenshot displays the Aptio Setup Utility interface for the BOXER-6640M. The title bar reads "Aptio Setup Utility - Copyright (C) 2017 American Megatrends, Inc." and the current menu is "Chipset". The main area is divided into two columns. The left column, titled "System Agent (SA) Configuration", lists "Memory Configuration" with sub-items "Memory Frequency" (2133 MHz) and "Total Memory" (4096 MB), followed by a selected "Graphics Configuration" option. The right column, titled "Graphics Configuration", is currently empty. A legend at the bottom right of the main area lists navigation keys: ++ for Select Screen, T1 for Select Item, Enter for Select, +/- for Change Opt., F1 for General Help, F2 for Previous Values, F3 for Optimized Defaults, F4 for Save & Exit, and ESC for Exit. The footer of the utility reads "Version 2.18.1263. Copyright (C) 2017 American Megatrends, Inc."

3.5.1.1 System Agent (SA) Configuration: Graphics Configuration

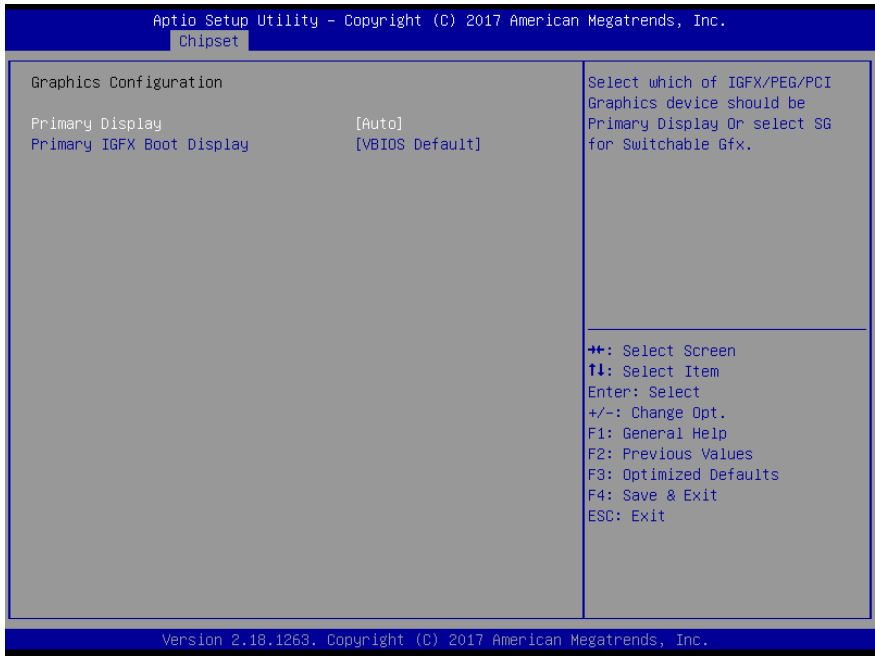

Options summary:

Primary Display	Auto	Optimal Default, Failsafe Default
	IGFX	
	PCI	
Select which of IGFX/PEG/PCI Graphics device should be Primary Display Or select SG for switchable Gfx.		
Primary IGFX Boot Display	VBIOS default	Optimal Default, Failsafe Default
	HDMI 1	
	CRT	
	HDMI 2	
Secondary IGFX Boot Display	Disable	Optimal Default, Failsafe Default
	HDMI 1	
	CRT	
	HDMI 2	

3.5.2 Chipset: PCH-IO Configuration

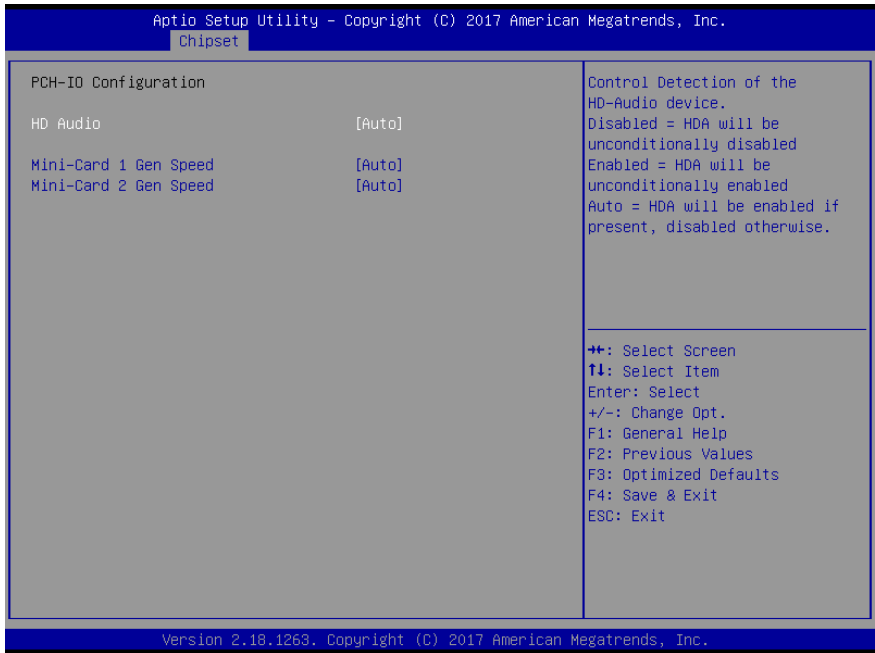

Options summary:

HD Audio	Disabled	Optimal Default, Failsafe Default
	Enabled	
	Auto	
Control Detection of the HD-Audio device. Disabled = HDA will be unconditionally disabled Enabled = HDA will be unconditionally enabled Auto = HDA will be enabled if present, disabled otherwise.		
Mini-Card 1 Gen Speed	Auto	Optimal Default, Failsafe Default
	Gen1	
	Gen2	
	Gen3	
Select PCI Express port speed		
Mini-Card 2 Gen Speed	Auto	Optimal Default, Failsafe Default
	Gen1	
	Gen2	
	Gen3	
Select PCI Express port speed		

3.6 Setup submenu: Security

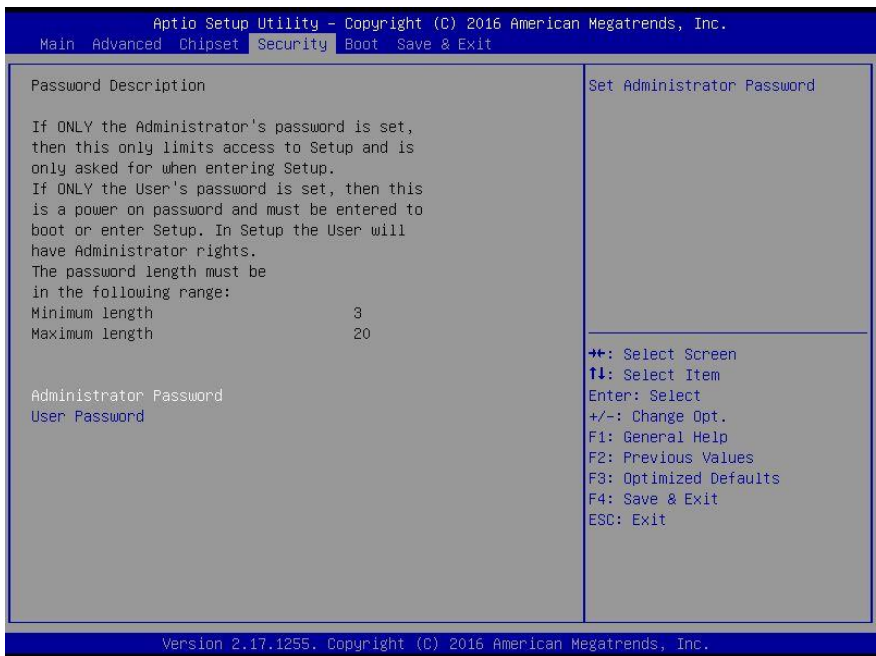

Change User/Administrator Password

You can set a User Password once an Administrator Password is set. The password will be required during boot up, or when the user enters the Setup utility. Please Note that a User Password does not provide access to many of the features in the Setup utility. Select the password you wish to set, press Enter to open a dialog box to enter your password (you can enter no more than six letters or numbers). Press Enter to confirm your entry, after which you will be prompted to retype your password for a final confirmation. Press Enter again after you have retyped it correctly.

Removing the Password

Highlight this item and type in the current password. At the next dialog box press Enter to disable password protection.

3.7 Setup submenu: Boot



Options summary:

Quiet Boot	Disabled	Optimal Default, Failsafe Default
	Enabled	
Enables or disables Quiet Boot option.		
Launch PXE ROM	Disabled	Optimal Default, Failsafe Default
	Enabled	
Controls the execution of UEFI and Legacy PXE ROM.		

3.8 Setup submenu: Save & Exit

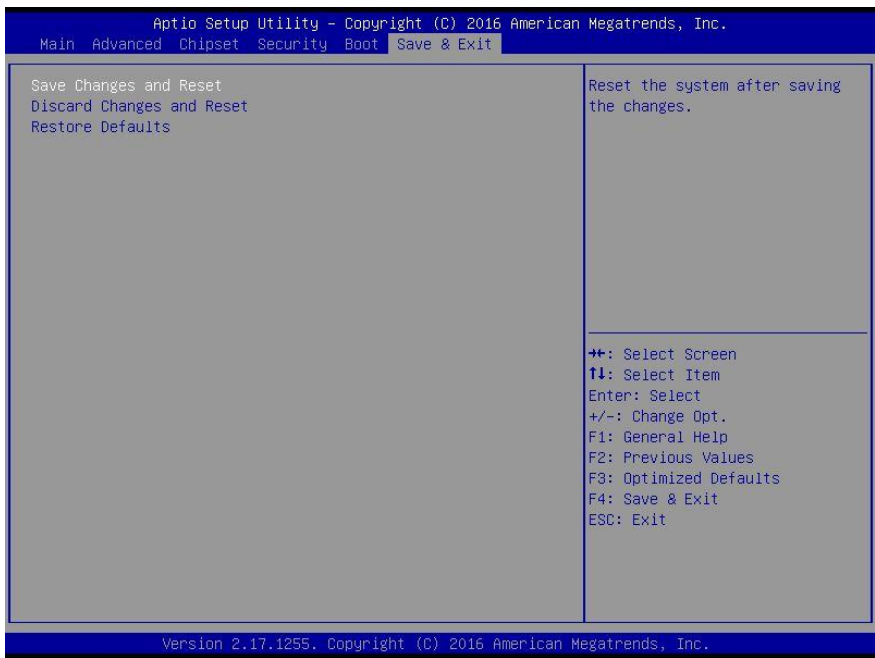

Chapter 4

Drivers Installation

4.1 Product CD/DVD

The BOXER-6640M comes with a product DVD that contains all the drivers and utilities you need to setup your product. Insert the DVD and follow the steps in the autorun program to install the drivers.

In case the program does not start, follow the sequence below to install the drivers.

Step 1 – Install Chipset Driver

1. Open the **Step1 - Chipset** folder and select your OS
2. Open the **SetupChipset.exe** file in the folder
3. Follow the instructions
4. Drivers will be installed automatically

Step 2 – Install Graphics Driver

1. Open the **Step2 - Graphic** folder and select your OS
2. Open the **Setup.exe** file in the folder
3. Follow the instructions
4. Drivers will be installed automatically

Step 3 – Install LAN Driver

1. Open the **Step3 - LAN** folder and select your OS
2. Open the **.exe** file in the folder
3. Follow the instructions
4. Drivers will be installed automatically

Step 4 – Install Audio Driver

1. Open the **Step4 - Audio** folder and select your OS
2. followed by the **.exe** file in the folder
3. Follow the instructions
4. Drivers will be installed automatically

Step 5 – Install USB3.0 Driver

1. Open the **Step5 – USB3.0** folder and select your OS
2. Open the **.exe** file in the folder
3. Follow the instructions
4. Drivers will be installed automatically

Step 6 – Install ME Driver

1. Open the **Step6 - ME** folder and select your OS
2. Open the **SetupME.exe** file in the folder
3. Follow the instructions
4. Drivers will be installed automatically

Appendix A

Watchdog Timer Programming

A.1 Watchdog Timer Initial Program

Table 1 : SuperIO relative register table		
	Default Value	Note
Index	0x2E(Note1)	SIO MB PnP Mode Index Register 0x2E or 0x4E
Data	0x2F(Note2)	SIO MB PnP Mode Data Register 0x2F or 0x4F

Table 2 : Watchdog relative register table					
	LDN	Register	BitNum	Value	Note
Timer Counter	0x07(Note3)	0xF6(Note4)		(Note24)	Time of watchdog timer (0~255) This register is byte access
Counting Unit	0x07(Note5)	0xF5(Note6)	3(Note7)	0(Note8)	Select time unit. 0: second 1: minute
Watchdog Enable	0x07(Note9)	0xF5(Note10)	5(Note11)	1(Note12)	0: Disable 1: Enable
Timeout Status	0x07(Note13)	0xF5(Note14)	6(Note15)	1	1: Clear timeout status
Output Mode	0x07(Note16)	0xF5(Note17)	4(Note18)	1(Note19)	Select WDTRST# output mode 0: level 1: pulse
WDTRST output	0x07(Note20)	0xFA(Note21)	0(Note22)	1(Note23)	Enable/Disable time out output via WDTRST# 0: Disable 1: Enable

```

*****
// SuperIO relative definition (Please reference to Table 1)
#define byte SIOIndex //This parameter is represented from Note1
#define byte SIOData //This parameter is represented from Note2
#define void IOWriteByte(byte IOPort, byte Value);
#define byte IOReadByte(byte IOPort);
// Watch Dog relative definition (Please reference to Table 2)
#define byte TimerLDN //This parameter is represented from Note3
#define byte TimerReg //This parameter is represented from Note4
#define byte TimerVal // This parameter is represented from Note24
#define byte UnitLDN //This parameter is represented from Note5
#define byte UnitReg //This parameter is represented from Note6
#define byte UnitBit //This parameter is represented from Note7
#define byte UnitVal //This parameter is represented from Note8
#define byte EnableLDN //This parameter is represented from Note9
#define byte EnableReg //This parameter is represented from Note10
#define byte EnableBit //This parameter is represented from Note11
#define byte EnableVal //This parameter is represented from Note12
#define byte StatusLDN // This parameter is represented from Note13
#define byte StatusReg // This parameter is represented from Note14
#define byte StatusBit // This parameter is represented from Note15
#define byte ModeLDN // This parameter is represented from Note16
#define byte ModeReg // This parameter is represented from Note17
#define byte ModeBit // This parameter is represented from Note18
#define byte ModeVal // This parameter is represented from Note19
#define byte WDRstLDN // This parameter is represented from Note20
#define byte WDRstReg // This parameter is represented from Note21
#define byte WDRstBit // This parameter is represented from Note22
#define byte WDRstVal // This parameter is represented from Note23
*****

```

```
*****  
***  
VOID Main(){  
    // Procedure : AaeonWDTConfig  
    // (byte)Timer : Time of WDT timer.(0x00~0xFF)  
    // (boolean)Unit : Select time unit(0: second, 1: minute).  
    AaeonWDTConfig();  
  
    // Procedure : AaeonWDTEnable  
    // This procedure will enable the WDT counting.  
    AaeonWDTEnable();  
}  
*****  
***
```

```

*****
***
// Procedure : AaeonWDTEnable
VOID AaeonWDTEnable (){
    WDTEnableDisable(EnableLDN, EnableReg, EnableBit, 1);
}

// Procedure : AaeonWDTConfig
VOID AaeonWDTConfig (){
    // Disable WDT counting
    WDTEnableDisable(EnableLDN, EnableReg, EnableBit, 0);
    // Clear Watchdog Timeout Status
    WDTClearTimeoutStatus();
    // WDT relative parameter setting
    WDTParameterSetting();
}

VOID WDTEnableDisable(byte LDN, byte Register, byte BitNum, byte Value){
    SIOBitSet(LDN, Register, BitNum, Value);
}

VOID WDTParameterSetting(){
    // Watchdog Timer counter setting
    SIOByteSet(TimerLDN, TimerReg, TimerVal);
    // WDT counting unit setting
    SIOBitSet(UnitLDN, UnitReg, UnitBit, UnitVal);
    // WDT output mode setting, level / pulse
    SIOBitSet(ModeLDN, ModeReg, ModeBit, ModeVal);
    // Watchdog timeout output via WDTRST#
    SIOBitSet(WDTRstLDN, WDTRstReg, WDTRstBit, WDTRstVal);
}

VOID WDTClearTimeoutStatus(){
    SIOBitSet(StatusLDN, StatusReg, StatusBit, 1);
}
*****
***

```

```

*****
***
VOID SIOEnterMBPnPMode(){
    IOWriteByte(SIOIndex, 0x87);
    IOWriteByte(SIOIndex, 0x87);
}

VOID SIOExitMBPnPMode(){
    IOWriteByte(SIOIndex, 0xAA);
}

VOID SIOSelectLDN(byte LDN){
    IOWriteByte(SIOIndex, 0x07); // SIO LDN Register Offset = 0x07
    IOWriteByte(SIOData, LDN);
}

VOID SIOBitSet(byte LDN, byte Register, byte BitNum, byte Value){
    Byte TmpValue;

    SIOEnterMBPnPMode();
    SIOSelectLDN(byte LDN);
    IOWriteByte(SIOIndex, Register);
    TmpValue = IOReadByte(SIOData);
    TmpValue &= ~(1 << BitNum);
    TmpValue |= (Value << BitNum);
    IOWriteByte(SIOData, TmpValue);
    SIOExitMBPnPMode();
}

VOID SIOByteSet(byte LDN, byte Register, byte Value){
    SIOEnterMBPnPMode();
    SIOSelectLDN(LDN);
    IOWriteByte(SIOIndex, Register);
    IOWriteByte(SIOData, Value);
    SIOExitMBPnPMode();
}
*****
***

```

Appendix B

I/O Information















B.1 I/O Address Map

Input/output (IO)	
[0000000000000000 - 00000000000000CF]	PCI Express Root Complex
[0000000000000020 - 0000000000000021]	Programmable interrupt controller
[0000000000000024 - 0000000000000025]	Programmable interrupt controller
[0000000000000028 - 0000000000000029]	Programmable interrupt controller
[000000000000002C - 000000000000002D]	Programmable interrupt controller
[000000000000002E - 000000000000002F]	Motherboard resources
[0000000000000030 - 0000000000000031]	Programmable interrupt controller
[0000000000000034 - 0000000000000035]	Programmable interrupt controller
[0000000000000038 - 0000000000000039]	Programmable interrupt controller
[000000000000003C - 000000000000003D]	Programmable interrupt controller
[0000000000000040 - 0000000000000043]	System timer
[000000000000004E - 000000000000004F]	Motherboard resources
[0000000000000050 - 0000000000000053]	System timer
[0000000000000061 - 0000000000000061]	Motherboard resources
[0000000000000063 - 0000000000000063]	Motherboard resources
[0000000000000065 - 0000000000000065]	Motherboard resources
[0000000000000067 - 0000000000000067]	Motherboard resources
[0000000000000070 - 0000000000000070]	Motherboard resources
[0000000000000070 - 0000000000000077]	System CMOS/real time clock
[0000000000000080 - 0000000000000080]	Motherboard resources
[0000000000000092 - 0000000000000092]	Motherboard resources
[00000000000000A0 - 00000000000000A1]	Programmable interrupt controller
[00000000000000A4 - 00000000000000A5]	Programmable interrupt controller
[00000000000000A8 - 00000000000000A9]	Programmable interrupt controller
[00000000000000AC - 00000000000000AD]	Programmable interrupt controller
[00000000000000B0 - 00000000000000B1]	Programmable interrupt controller
[00000000000000B2 - 00000000000000B3]	Motherboard resources
[00000000000000B4 - 00000000000000B5]	Programmable interrupt controller
[00000000000000B8 - 00000000000000B9]	Programmable interrupt controller
[00000000000000BC - 00000000000000BD]	Programmable interrupt controller
[00000000000000F0 - 00000000000000F0]	Numeric data processor
[00000000000003B0 - 00000000000003BB]	Intel(R) HD Graphics 630
[00000000000003C0 - 00000000000003DF]	Intel(R) HD Graphics 630
[00000000000003F8 - 00000000000003FF]	Communications Port (COM1)
[00000000000004D0 - 00000000000004D1]	Programmable interrupt controller
[0000000000000680 - 000000000000069F]	Motherboard resources
[0000000000000800 - 000000000000087F]	Motherboard resources
[0000000000000A00 - 0000000000000A0F]	Motherboard resources
[0000000000000A10 - 0000000000000A1F]	Motherboard resources
[0000000000000A20 - 0000000000000A2F]	Motherboard resources
[0000000000000D00 - 0000000000000FFF]	PCI Express Root Complex
[000000000000164E - 000000000000164F]	Motherboard resources
[0000000000001800 - 00000000000018FE]	Motherboard resources
[0000000000001854 - 0000000000001857]	Motherboard resources
[00000000000006000 - 00000000000006FFF]	Intel(R) 100 Series/C230 Series Chipset Family PCI Express Root Port #13 - A11C
[00000000000007000 - 00000000000007FFF]	Intel(R) 100 Series/C230 Series Chipset Family PCI Express Root Port #12 - A11B
[00000000000008000 - 00000000000008FFF]	Intel(R) 100 Series/C230 Series Chipset Family PCI Express Root Port #11 - A11A
[00000000000009000 - 00000000000009FFF]	Intel(R) 100 Series/C230 Series Chipset Family PCI Express Root Port #8 - A117
[0000000000000A000 - 0000000000000AFF]	Intel(R) 100 Series/C230 Series Chipset Family PCI Express Root Port #7 - A116
[0000000000000B000 - 0000000000000BFFF]	Intel(R) 100 Series/C230 Series Chipset Family PCI Express Root Port #6 - A115







	[000000000000C000 - 000000000000CFFF]	Intel(R) 100 Series/C230 Series Chipset Family PCI Express Root Port #5 - A114
	[000000000000D000 - 000000000000DFFF]	Intel(R) 100 Series/C230 Series Chipset Family PCI Express Root Port #4 - A113
	[000000000000E000 - 000000000000EFFF]	Intel(R) 100 Series/C230 Series Chipset Family PCI Express Root Port #3 - A112
	[000000000000F000 - 000000000000F03F]	Intel(R) HD Graphics 630
	[000000000000F040 - 000000000000F05F]	Intel(R) 100 Series/C230 Series Chipset Family SMBus - A123
	[000000000000F060 - 000000000000F07F]	Standard SATA AHCI Controller
	[000000000000F080 - 000000000000F083]	Standard SATA AHCI Controller
	[000000000000F090 - 000000000000F097]	Standard SATA AHCI Controller
	[000000000000FF00 - 000000000000FFFE]	Motherboard resources
	[000000000000FFFF - 000000000000FFFF]	Motherboard resources
	[000000000000FFFF - 000000000000FFFF]	Motherboard resources
	[000000000000FFFF - 000000000000FFFF]	Motherboard resources

B.2 Memory Address Map

Memory	
[0000000000A0000 - 0000000000BFFFF]	Intel(R) HD Graphics 630
[0000000000A0000 - 0000000000BFFFF]	PCI Express Root Complex
[0000000090000000 - 00000000DFFFFFF]	PCI Express Root Complex
[00000000C0000000 - 00000000CFFFFFF]	Intel(R) HD Graphics 630
[00000000E0000000 - 00000000EFFFFFF]	Intel(R) HD Graphics 630
[00000000DF000000 - 00000000DF01FFFF]	Intel(R) I210 Gigabit Network Connection #2
[00000000DF000000 - 00000000DF0FFFFF]	Intel(R) 100 Series/C230 Series Chipset Family PCI Express Root Port #13 - A11C
[00000000DF020000 - 00000000DF023FFF]	Intel(R) I210 Gigabit Network Connection #2
[00000000DF100000 - 00000000DF11FFFF]	Intel(R) I210 Gigabit Network Connection
[00000000DF100000 - 00000000DF1FFFFF]	Intel(R) 100 Series/C230 Series Chipset Family PCI Express Root Port #12 - A11B
[00000000DF120000 - 00000000DF123FFF]	Intel(R) I210 Gigabit Network Connection
[00000000DF200000 - 00000000DF21FFFF]	Intel(R) I210 Gigabit Network Connection #7
[00000000DF200000 - 00000000DF2FFFFF]	Intel(R) 100 Series/C230 Series Chipset Family PCI Express Root Port #11 - A11A
[00000000DF220000 - 00000000DF223FFF]	Intel(R) I210 Gigabit Network Connection #7
[00000000DF300000 - 00000000DF31FFFF]	Intel(R) I210 Gigabit Network Connection #6
[00000000DF300000 - 00000000DF3FFFFF]	Intel(R) 100 Series/C230 Series Chipset Family PCI Express Root Port #8 - A117
[00000000DF320000 - 00000000DF323FFF]	Intel(R) I210 Gigabit Network Connection #6
[00000000DF400000 - 00000000DF41FFFF]	Intel(R) I210 Gigabit Network Connection #5
[00000000DF400000 - 00000000DF4FFFFF]	Intel(R) 100 Series/C230 Series Chipset Family PCI Express Root Port #7 - A116
[00000000DF420000 - 00000000DF423FFF]	Intel(R) I210 Gigabit Network Connection #5
[00000000DF500000 - 00000000DF51FFFF]	Intel(R) I210 Gigabit Network Connection #4
[00000000DF500000 - 00000000DF5FFFFF]	Intel(R) 100 Series/C230 Series Chipset Family PCI Express Root Port #6 - A115
[00000000DF520000 - 00000000DF523FFF]	Intel(R) I210 Gigabit Network Connection #4
[00000000DF600000 - 00000000DF61FFFF]	Intel(R) I210 Gigabit Network Connection #3
[00000000DF600000 - 00000000DF6FFFFF]	Intel(R) 100 Series/C230 Series Chipset Family PCI Express Root Port #5 - A114
[00000000DF620000 - 00000000DF623FFF]	Intel(R) I210 Gigabit Network Connection #3
[00000000DF700000 - 00000000DF71FFFF]	Intel(R) I210 Gigabit Network Connection #9
[00000000DF700000 - 00000000DF7FFFFF]	Intel(R) 100 Series/C230 Series Chipset Family PCI Express Root Port #4 - A113
[00000000DF720000 - 00000000DF723FFF]	Intel(R) I210 Gigabit Network Connection #9
[00000000DF800000 - 00000000DF81FFFF]	Intel(R) I210 Gigabit Network Connection #8
[00000000DF800000 - 00000000DF8FFFFF]	Intel(R) 100 Series/C230 Series Chipset Family PCI Express Root Port #3 - A112
[00000000DF820000 - 00000000DF823FFF]	Intel(R) I210 Gigabit Network Connection #8
[00000000DF900000 - 00000000DF90FFFF]	High Definition Audio Controller
[00000000DF910000 - 00000000DF91FFFF]	Intel(R) USB 3.0 eXtensible Host Controller - 1.0 (Microsoft)
[00000000DF920000 - 00000000DF923FFF]	High Definition Audio Controller
[00000000DF924000 - 00000000DF927FFF]	Intel(R) 100 Series/C230 Series Chipset Family PMC - A121
[00000000DF928000 - 00000000DF929FFF]	Standard SATA AHCI Controller
[00000000DF92A000 - 00000000DF92A0FF]	Intel(R) 100 Series/C230 Series Chipset Family SMBus - A123
[00000000DF92B000 - 00000000DF92B7FF]	Standard SATA AHCI Controller
[00000000DF92C000 - 00000000DF92C0FF]	Standard SATA AHCI Controller
[00000000DF92E000 - 00000000DF92EFFF]	Intel(R) 100 Series/C230 Series Chipset Family Thermal subsystem - A131
[00000000DFFE0000 - 00000000DFFFFFFF]	Motherboard resources
[00000000E0000000 - 00000000EFFFFFFF]	Motherboard resources
[00000000FD000000 - 00000000FDABFFFF]	Motherboard resources
[00000000FD000000 - 00000000FE7FFFFF]	PCI Express Root Complex
[00000000FDAC0000 - 00000000FDACFFFF]	Motherboard resources
[00000000FDAD0000 - 00000000FDADFFFF]	Motherboard resources
[00000000FDAE0000 - 00000000FDAEFFFF]	Motherboard resources
[00000000FDAF0000 - 00000000FDAFFFFF]	Motherboard resources
[00000000FDB00000 - 00000000FDFFFFFF]	Motherboard resources

	[00000000FE000000 - 00000000FE01FFFF] Motherboard resources
	[00000000FE036000 - 00000000FE03BFFF] Motherboard resources
	[00000000FE03D000 - 00000000FE3FFFFF] Motherboard resources
	[00000000FE40F000 - 00000000FE40FFFF] Intel(R) Management Engine Interface
	[00000000FE410000 - 00000000FE7FFFFF] Motherboard resources
	[00000000FED00000 - 00000000FED003FF] High precision event timer
	[00000000FED10000 - 00000000FED17FFF] Motherboard resources
	[00000000FED18000 - 00000000FED18FFF] Motherboard resources
	[00000000FED19000 - 00000000FED19FFF] Motherboard resources
	[00000000FED20000 - 00000000FED3FFFF] Motherboard resources
	[00000000FED45000 - 00000000FED8FFFF] Motherboard resources
	[00000000FED90000 - 00000000FED93FFF] Motherboard resources
	[00000000FEE00000 - 00000000FEEFFFFF] Motherboard resources
	[00000000FF000000 - 00000000FFFFFFFF] Legacy device
	[00000000FF000000 - 00000000FFFFFFFF] Motherboard resources

B.3 IRQ Mapping Chart

- ▼  Interrupt request (IRQ)
 -  (ISA) 0x00000000 (00) System timer
 -  (ISA) 0x00000004 (04) Communications Port (COM1)
 -  (ISA) 0x00000008 (08) System CMOS/real time clock
 -  (ISA) 0x0000000D (13) Numeric data processor
 -  (ISA) 0x0000000E (14) Motherboard resources