

Picture differs from the item.

RoHS Compliant

Color:

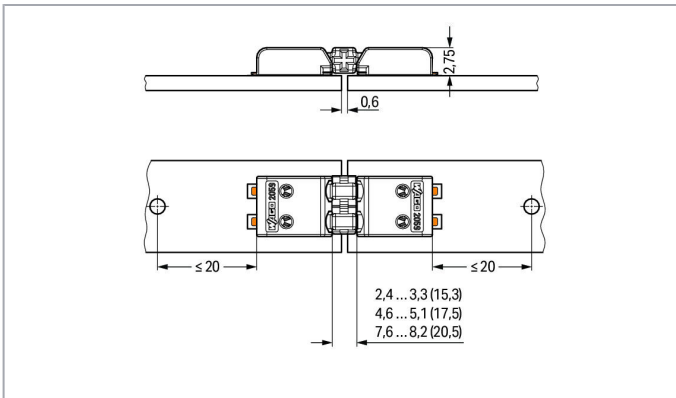

### Item description

- Board-to-board links simplify LED module assembly
- Easy push-in connection and disconnection

### Data

#### Electrical data

Subject to changes. Please also observe the further product documentation!

WAGO Kontakttechnik GmbH & Co. KG  
Hansastr. 27  
32423 Minden  
Phone: +49571 887-0 | Fax: +49571 887-169  
Email: [info.de@wago.com](mailto:info.de@wago.com) | Web: [www.wago.com](http://www.wago.com)

Do you have any questions about our products?  
We are always happy to take your call at +49 (571) 887-44222.

## Ratings per IEC/EN

Ratings per	IEC/EN 60664-1
Nominal voltage (III/3)	63 V
Rated surge voltage (III/3)	2.5 kV
Rated voltage (III/2)	160 V
Rated surge voltage (III/2)	2.5 kV
Nominal voltage (II/2)	320 V
Rated surge voltage (II/2)	2.5 kV
Rated current	3 A
Legend (ratings)	(III / 2) $\triangleq$ Overvoltage category III / Pollution degree 2

## Connection data

Pole No.	3
Total number of potentials	3

## Physical data

Pin spacing	3 mm / 0.118 inch
Width	8.7 mm / 0.343 inch
Height	2.5 mm / 0.098 inch
Depth	20.5 mm / 0.807 inch

## Mechanical data

Mating cycles (max.)	10
Number of mating cycles	max. 10 connections/disconnections
Suitable	for SMD PCB terminal blocks (2059 Series)

## Material data

Color	white
Material group	I
Insulation material	Polyamide (PA66)
Flammability class per UL94	V0
Contact material	Copper alloy
Contact plating	silver-plated
Weight	0.2 g

Subject to changes. Please also observe the further product documentation!

## Environmental requirements





Limit temperature range	-60 ... +105 °C
-------------------------	-----------------

## Commercial data

Packaging type	BOX
Country of origin	CN
GTIN	4055143610001
Customs tariff number	85369010000

## Approvals / Certificates

### Country specific Approvals

Logo	Approval	Additional Approval Text	Certificate name
	CCA DEKRA Certification B.V.	EN 60947-7-4	NTR NL-7680
	CCA DEKRA Certification B.V.	EN 60838	NTR NL-7720
	KEMA/KEUR DEKRA Certification B.V.	EN 60947-7-4	71-103560
	KEMA/KEUR DEKRA Certification B.V.	EN 60838	71-106226

### UL-Approvals

Logo	Approval	Additional Approval Text	Certificate name
	UL Underwriters Laboratories Inc.	UL 1977	E45171

Subject to changes. Please also observe the further product documentation!

## Downloads

### Documentation

#### Additional Information

Technical explanations	3. 4. 2019	pdf 2.0 MB	Download
------------------------	------------	---------------	----------

## CAD/CAE-Data

### CAD data

2D/3D Models 2059-903/021-000	URL	Download
-------------------------------	-----	----------

### CAE data

ZUKEN Portal 2059-903/021-000	URL	Download
-------------------------------	-----	----------

## Environmental Product Compliance

### Compliance Search

Environmental Product Compliance 2059-903/021-000 Board-to-Board Link; Pin spacing 3 mm; 3-pole; Length: 20.5 mm; white	URL	Download
--	-----	----------

## Installation Notes

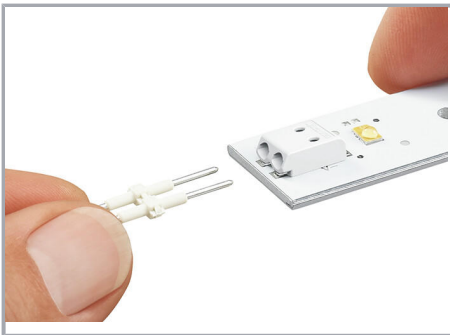

Subject to changes. Please also observe the further product documentation!

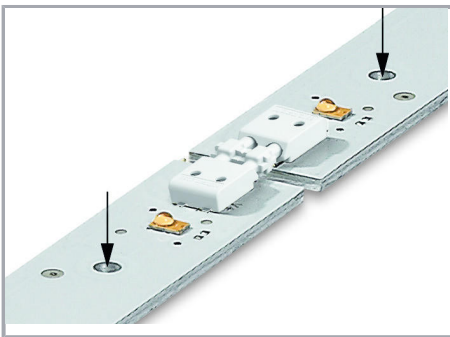
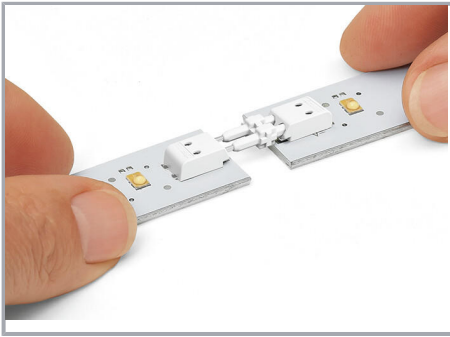

Subject to changes. Please also observe the further product documentation!