

# R&S® ZNB VECTOR NETWORK ANALYZER

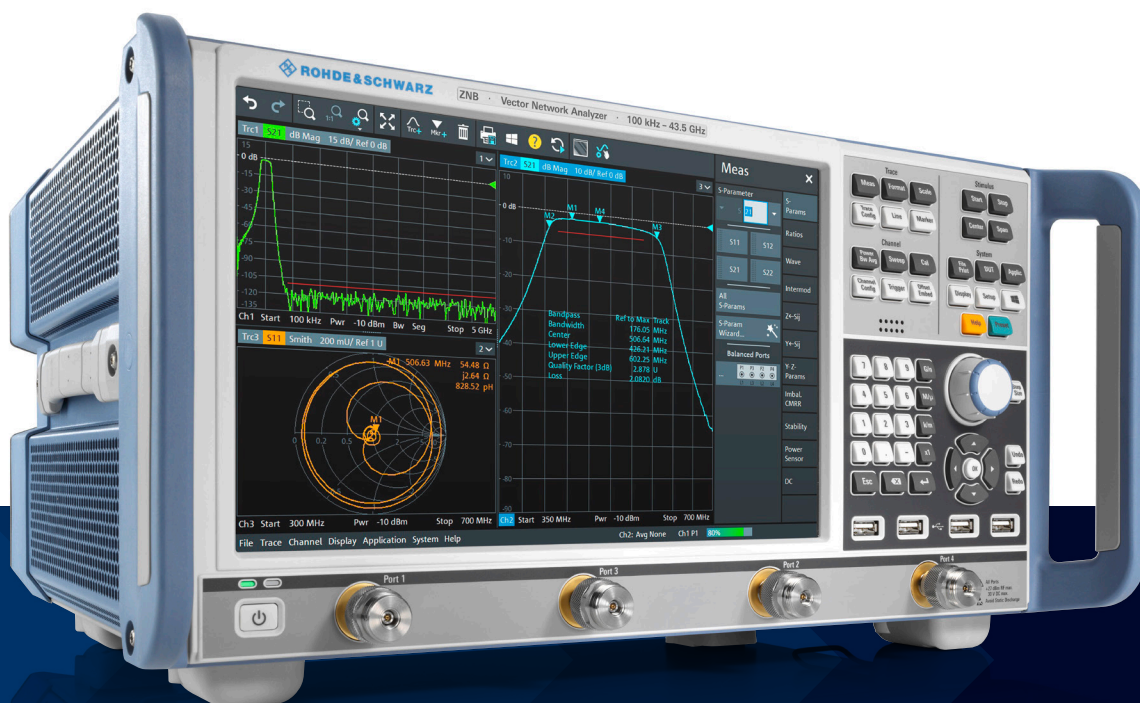

Outstanding speed, dynamic range  
and ease of operation



Product Brochure  
Version 03.00

**ROHDE & SCHWARZ**  
Make ideas real



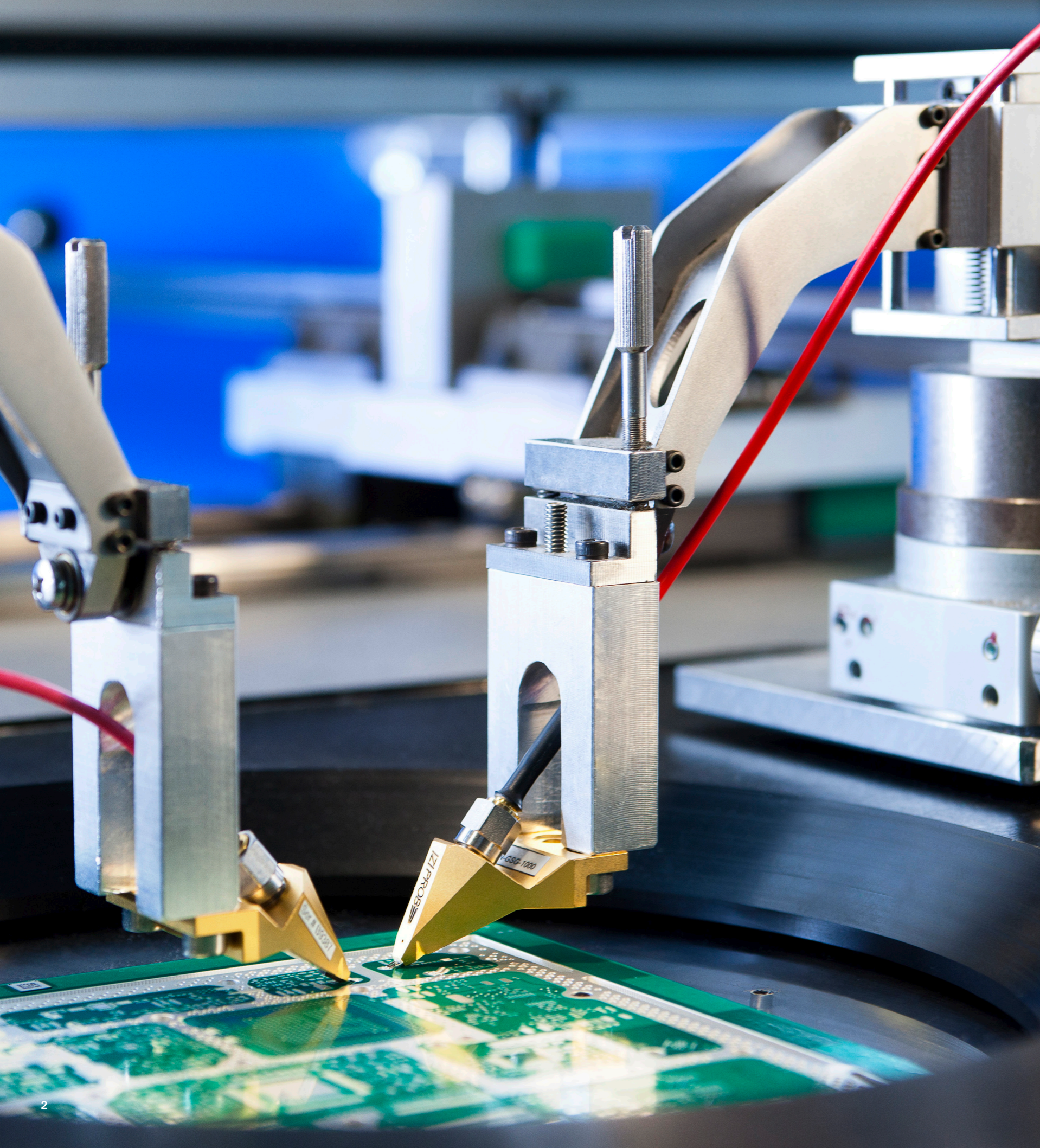

# CONTENTS

## Overview

- At a glance**  
▶ page 4
- Clearly structured user interface**  
▶ page 6
- Wide range of connectivity and extension options**  
▶ page 8

## Highlights

- Excellent RF performance**  
▶ page 10
- Intuitive GUI that speaks the user's language**  
▶ page 12
- High throughput in production**  
▶ page 14
- Calibration made easy**  
▶ page 16
- Embedding/deembedding for a diverse range of test fixtures**  
▶ page 18
- Real-time measurement uncertainty analysis**  
▶ page 20

## Applications

- Time domain analysis and signal integrity measurements**  
▶ page 22
- Fast EMC test site validation**  
▶ page 24
- Filter measurements**  
▶ page 25
- Measurements on up to 48 ports**  
▶ page 26
- Measurements on amplifiers and mixers**  
▶ page 28
- Tests in vacuum chambers and on multiport devices**  
▶ page 30

## Additional information

- Specifications in brief**  
▶ page 32
- Ordering information**  
▶ page 34

# AT A GLANCE

More than 70 years of experience in the field of vector network analysis pay off. Rohde & Schwarz sets new benchmarks with its R&S®ZNB family of vector network analyzers. These solid general purpose network analyzers combine high measurement speed and precision with exceptional ease of operation and a wide range of options for challenging applications. This product brochure presents the R&S®ZNB4, R&S®ZNB8, R&S®ZNB20, R&S®ZNB26 and R&S®ZNB43 models.

With frequency ranges from 9 kHz to 4.5/8.5 GHz and 100 kHz to 20/26.5/43.5 GHz, the R&S®ZNB vector network analyzers are typically targeted at applications in the communications, electronic goods and aerospace industries as well as in the design of digital high-speed printed circuit boards and cables.

The R&S®ZNB is the right choice when it comes to developing, producing and servicing RF components such as amplifiers, mixers, filters, connectors and cables.

The R&S®ZNB features a wide dynamic range of up to 140 dB (at 10 Hz IF bandwidth), low trace noise of less than 0.004 dB (RMS, at 10 kHz IF bandwidth) and high output power of up to +13 dBm, which can be adjusted electronically in a range of 95 dB.

The R&S®ZNB combines high measurement accuracy with exceptional speed – better than 5  $\mu$ s per point. It features excellent temperature and long-term stability, allowing reliable measurements over several days without recalibration.

The short-depth, compact 2-port and 4-port models leave plenty of space on the workbench for the measurement application. They feature impressively low operating noise thanks to low power consumption and a sophisticated cooling concept. Low power consumption also reduces operating costs and protects the environment.

## KEY FACTS

- ▶ Frequency ranges from 9 kHz up to 43.5 GHz
- ▶ Wide dynamic range of up to 140 dB
- ▶ Short sweep times, e.g. 4 ms for 401 points
- ▶ Wide power sweep range of 98 dB
- ▶ High temperature stability of typ. 0.01 dB/°C
- ▶ Wide range of IF bandwidths from 1 Hz to 10 MHz
- ▶ Manual and automatic calibration
- ▶ Extended embedding/deembedding capability
- ▶ 4-port models with two independent sources
- ▶ Expansion to up to 48 ports using switch matrices<sup>1)</sup>
- ▶ DUT-centric operating concept for even easier measurement setup
- ▶ Real-time analysis of measurement uncertainty

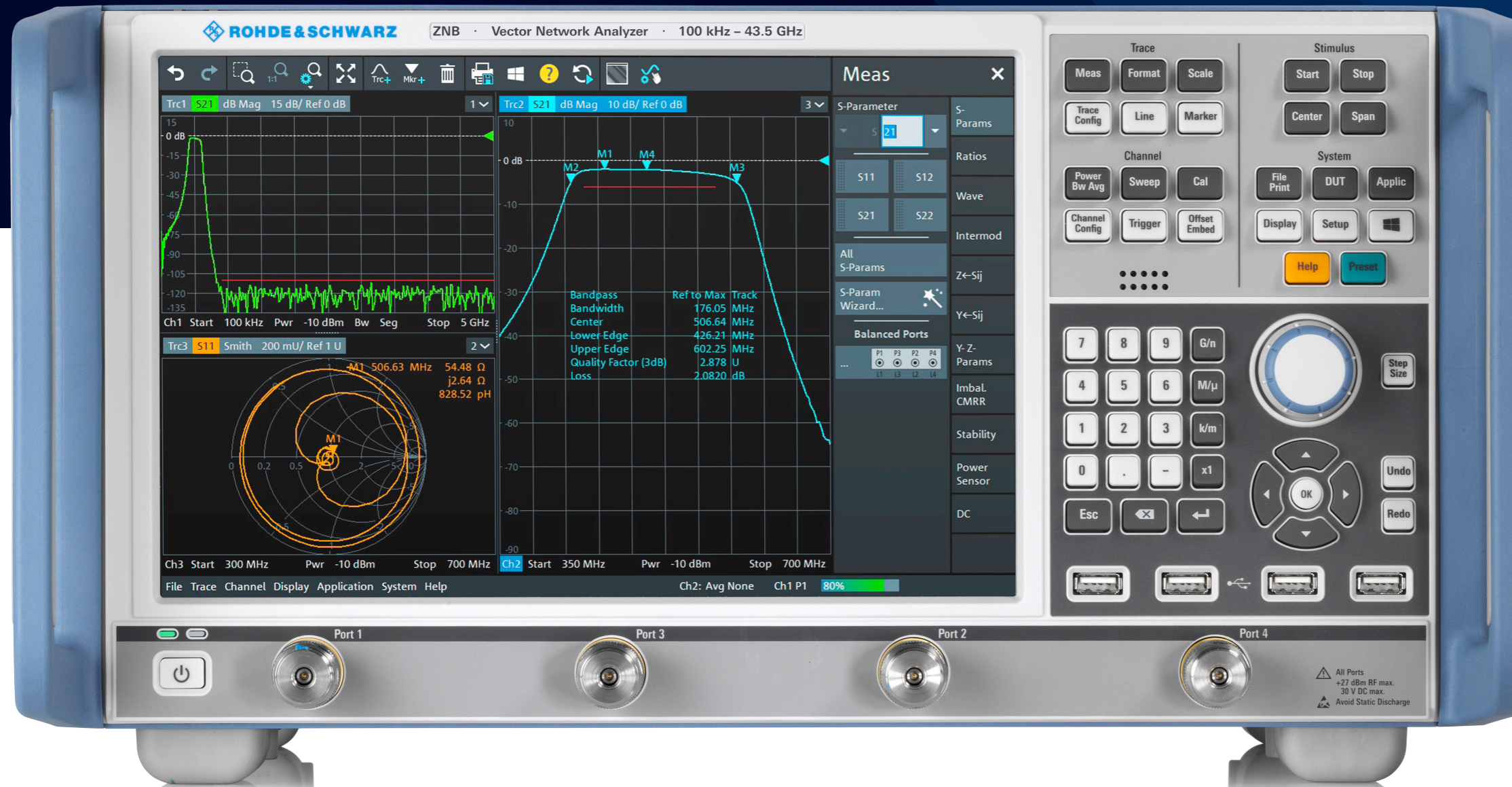

R&S®ZNB models<sup>2)</sup>

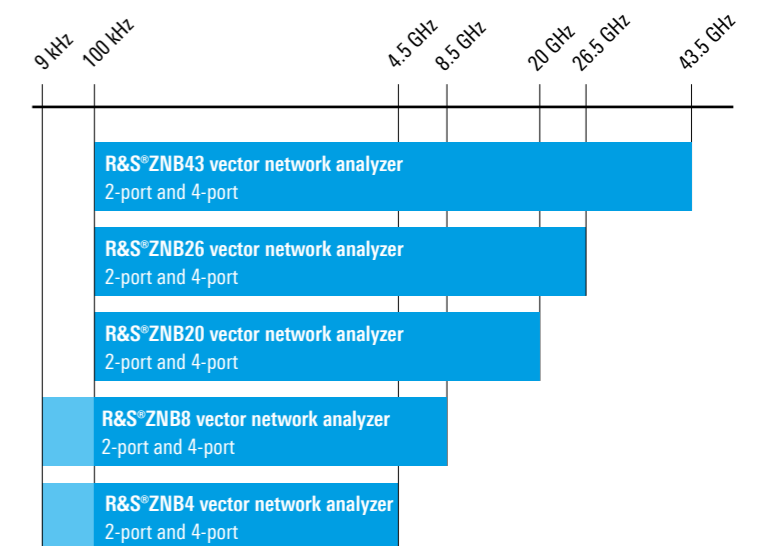

<sup>1)</sup> Up to 8.5 GHz only.

<sup>2)</sup> For R&S®ZNB40 model with a frequency range of 100 kHz (or 10 MHz) to 40 GHz, see PD 5214.5384.12.

# CLEARLY STRUCTURED USER INTERFACE



**Help**  
Context-sensitive help

**Undo/Redo (softkeys)**  
Cancels or restores the last one to six entries

**Preloaded setups**  
Switchover between instrument setups by touching or clicking a tab

**More than 100 channels and traces**  
Straightforward display of complex measurements

**Pop-up menus**  
Fast access to desired function

**Power on/off**  
LEDs indicate the operating state

**Up to four ports with ample spacing**  
Easy connection of DUT;  
plenty of space for connecting test cables

**Toolbar**  
Direct access to frequently used functions,  
e.g. zoom, new trace, new marker, save, print

**Large color multi-touchscreen (30 cm/12.1")**  
Clear display of a large number of traces

**Softkeys and soft panel**  
Optionally on the right or left side

**Hardkeys**  
Fast access to important menus – even when wearing gloves

**Help and preset**  
▶ Help: context-sensitive help  
▶ Preset: resets instrument to default state

**Undo/Redo (hardkeys)**  
Cancels or restores the last one to six entries

**USB connectors for accessories**  
For connecting power sensor, calibration unit,  
keyboard/mouse, storage media, etc.

**Transparent dialog windows**  
Traces remain visible

# WIDE RANGE OF CONNECTIVITY AND EXTENSION OPTIONS

## USB port

USB 3.0 Type-B  
for remote control of R&S®ZNB

## Additional (optional) internal hardware

- ▶ R&S®ZNBx-B2 2nd internal source for 4-port R&S®ZNB4/R&S®ZNB8/R&S®ZNB20/R&S®ZNB26/R&S®ZNB43
- ▶ R&S®ZNB-B4 precision frequency reference
- ▶ R&S®ZNBx-B2x extended power range
- ▶ R&S®ZNB4-B3x/R&S®ZNB8-B3x receiver step attenuator for R&S®ZNB4 and R&S®ZNB8

## DC inputs

R&S®ZNB-B81 option,  
four BNC connectors for DC measurements

## User port

25-pin D-Sub I/O connector  
for LVTTTL control signals (3.3 V)

## HDMI™ and DisplayPort connectors

## Removable SSD

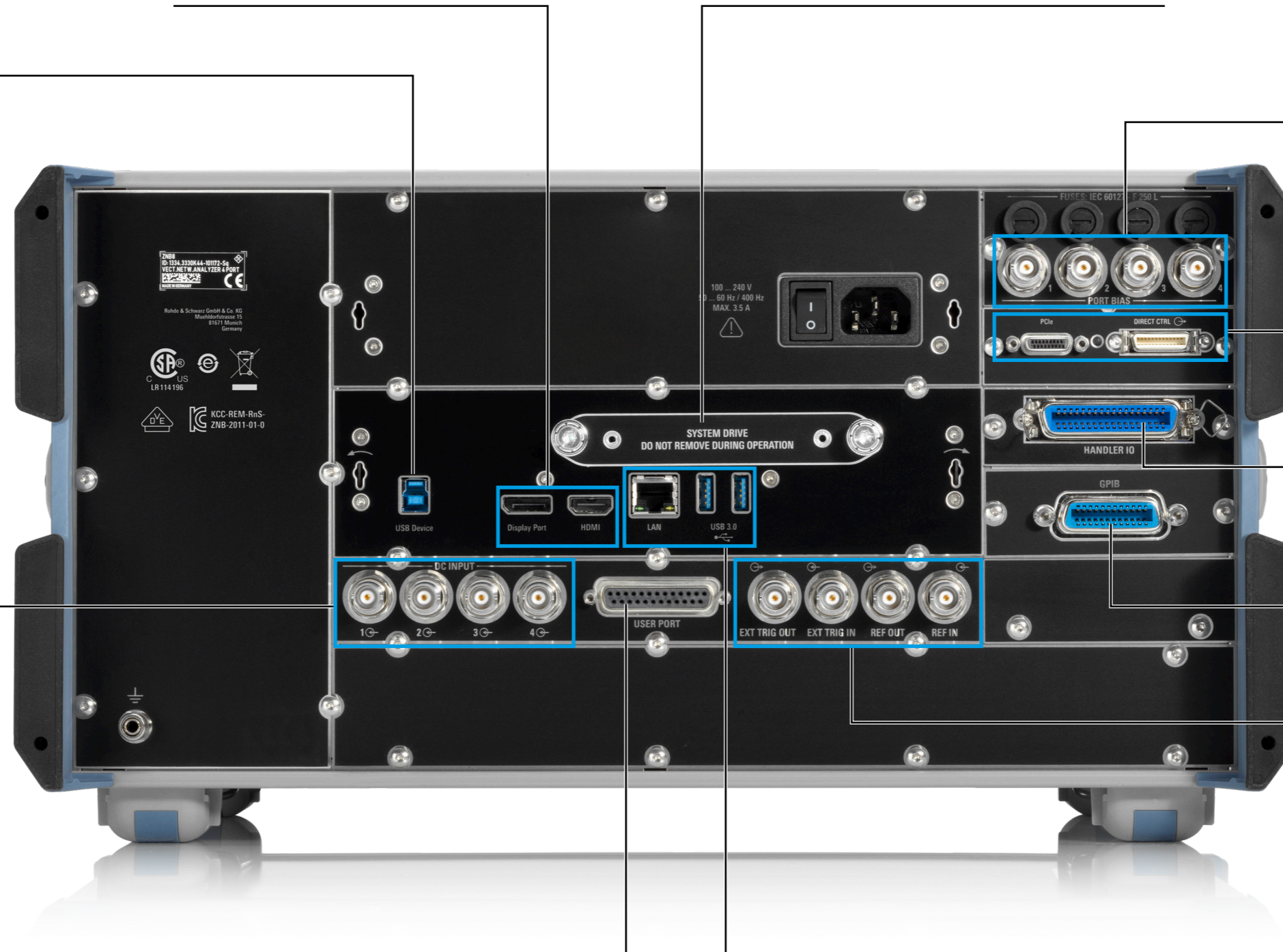

## Bias tees

R&S®ZNB-B1 option

## Device control interface

- R&S®ZNB-B12 option
- ▶ Direct control interface for controlling R&S®ZN-Z15 external RFFE GPIO interfaces or switch matrices
  - ▶ PCIe interface

## Handler I/O interface

R&S®ZN-B14 option,  
36-pin Centronics connector

## GPIB interface

R&S®ZNB-B10 option,  
GPIB interface in line with IEEE 488/IEC 625

## External trigger IN/OUT and REF IN/OUT

Four BNC connectors

## LAN and USB

RJ-45 connector and two USB 3.0 Type-A connectors

# EXCELLENT RF PERFORMANCE

The analyzers of the R&S®ZNB family combine wide dynamic range, excellent raw data, high temperature stability and fast synthesizers to deliver performance previously found only in high-end network analyzers. The R&S®ZNB is especially suitable for applications in the development and large-scale production of sophisticated RF components.

## Wide dynamic range

The measurement receivers in the R&S®ZNB combine excellent power handling capacity with high sensitivity and low trace noise. The R&S®ZNB base units provide typically 140 dB dynamic range (at 10 Hz IF bandwidth), outperforming other, comparable analyzers on the market.

The R&S®ZNB4-B52/-B54 and R&S®ZNB8-B52/-B54 options further extend the dynamic range to a value as high as 150 dB.

Users will benefit from the analyzer's wide dynamic range not only in the mobile radio frequency bands, but right from the 9 kHz start frequency.

## Excellent raw data

Even when uncalibrated, the R&S®ZNB offers directivity of more than 30 dB and uncorrected test port match of up to 30 dB. With partial calibration, for example transmission normalization with a through standard, the R&S®ZNB provides accuracy previously achieved only with a relatively complex 2-port calibration – with calibration taking typically half the time required for a full 2-port calibration.

## High measurement speed

The R&S®ZNB has fast synthesizers with switching times of below 10  $\mu$ s. This yields high sweep rates and allows the analyzer to perform measurements faster than competitor instruments. In parallel measurement mode (4-port instruments only), two 2-port DUTs can be simultaneously tested. This further reduces total measurement time.

R&S®ZNB dynamic range (at 10 Hz IF bandwidth).

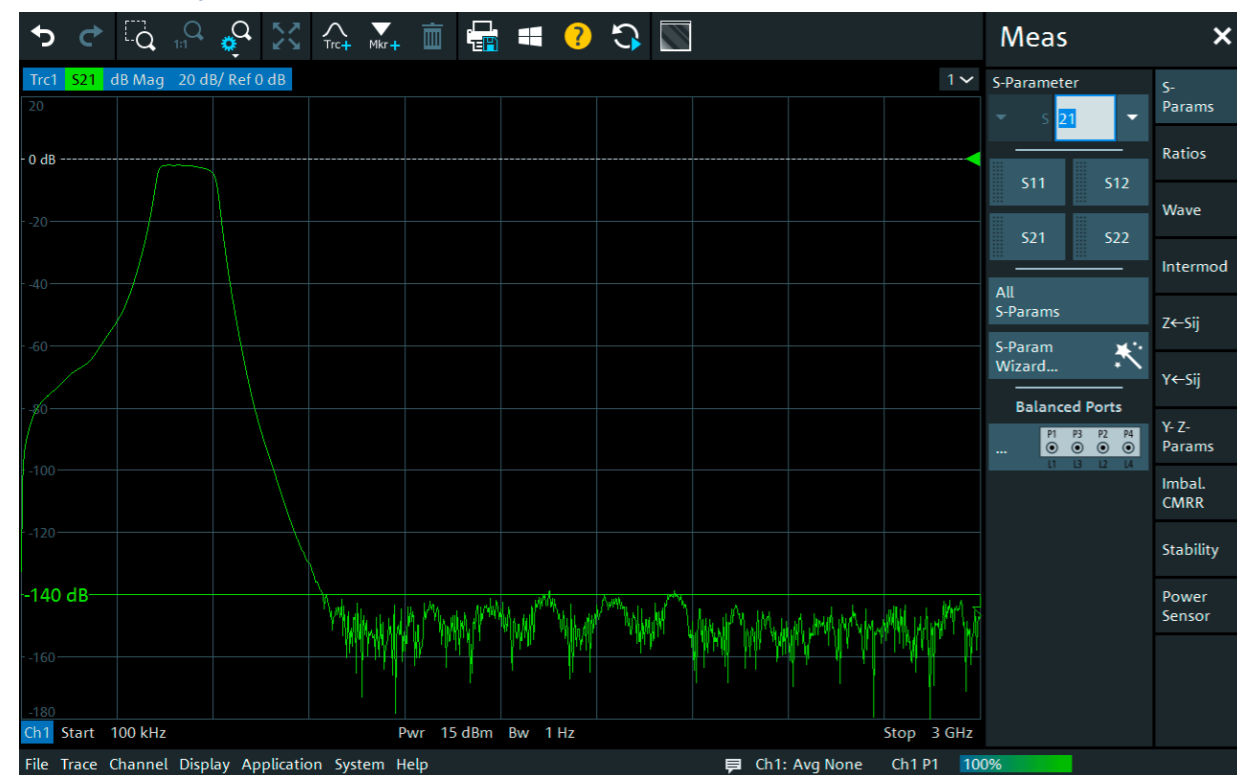

## High temperature and long-term stability

The R&S®ZNB test set and receivers feature excellent temperature and long-term stability. Magnitude and phase drift are very low, with typical values of less than 0.01 dB/°C and 0.15°/°C. A calibrated R&S®ZNB allows precise measurements over several days without recalibration.

## Mixed-mode S-parameters for balanced DUT characterization

The instrument can characterize both single-ended and differential DUTs. To characterize a DUT with two balanced ports, the R&S®ZNB treats the DUT like an unbalanced 4-port device. It calculates the 16 single-ended S-parameters and converts them to mixed-mode S-parameters. This additional computational effort does not compromise measurement speed. A wizard guides the user through the individual steps of the measurement – fast and straightforward.

## Redefined S-parameters for flexible test setup configuration

The R&S®ZNB firmware allows redefining S-parameters to support external test setups, e.g. a high-power test set. For this purpose, an external coupler decouples the reference signal and the signal reflected by the DUT. An example of this is given under "Redefined S-parameters" (lower diagram). The external coupler is connected to port 1 via the amplifier, and the reference and the reflected signal are measured via ports 2 and 3. The S-parameters can be redefined accordingly.  $S_{11}$  can be calculated as the wave ratio  $b_3/b_2$  using the signal from port 1.

Block diagram of an R&S®ZNB 4-port model with two internal sources

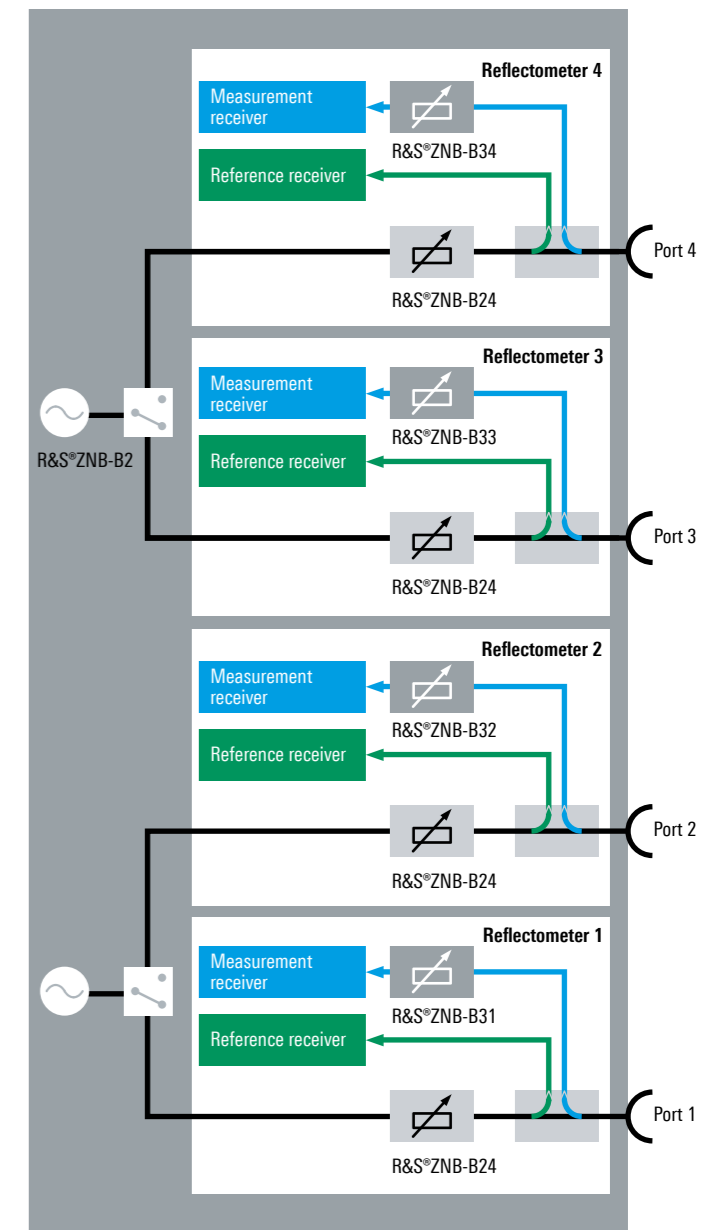

## Redefined S-parameters

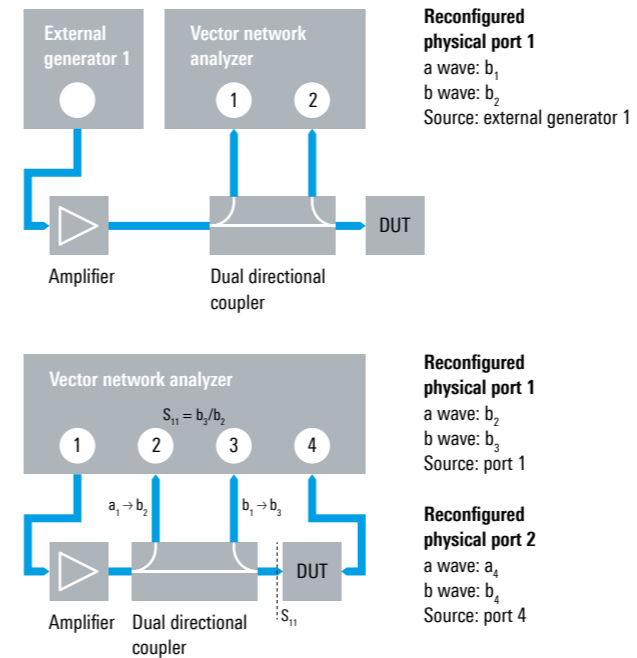

# INTUITIVE GUI THAT SPEAKS THE USER'S LANGUAGE

The R&S®ZNB turns into reality what many users desire: configuration, measurement and analysis as fast and intuitive as never before.

## Flat and clear menu structures for efficient operation

The R&S®ZNB groups together logically related control functions at a single operational level.

The **soft panel** shows all key functions and parameters that may be needed for a specific measurement and effectively helps users perform their tasks. Users can access all instrument functions in a maximum of three steps.

**Pop-up menus** allow many test parameters to be defined right where they are displayed.

**Wizards** guide the user through a sequence of steps, e.g. for configuring or calibrating an analyzer, reducing operator errors to a minimum.

## Efficient operation with multitouch gestures and flexible display configuration

Whether zooming, moving traces or adding markers: multitouch gestures make the R&S®ZNB very efficient to operate. On its brilliant 12.1" WXGA color touchscreen, the user can set up the display as required by arranging diagrams, traces, channels and markers in any desired combination. All of these elements can be dragged and dropped between diagrams or deleted to adapt the display to the measurement task at hand. The analyzer's intuitive user interface makes it is easy to get started with the R&S®ZNB and obtain results quickly.

## Zoom function

Users can zoom in and out with a simple multitouch gesture.

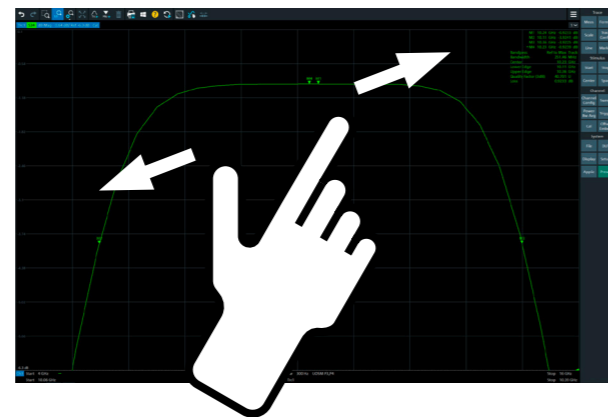
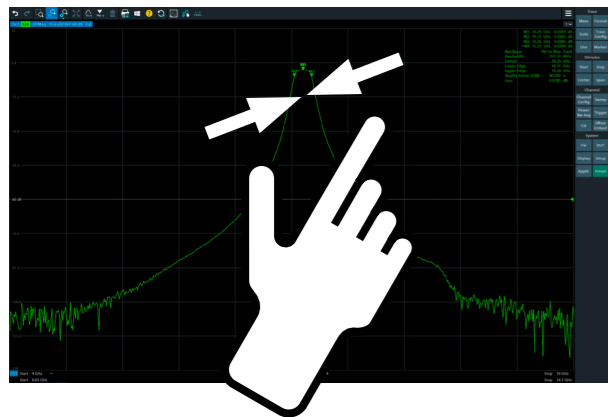

## Comprehensive trace analysis functions

A wide range of analysis functions help users evaluate important parameters in a straightforward manner:

- ▶ Ten markers per trace, including analysis functions and conversion to desired unit
- ▶ Automatic bandwidth measurements on filters
- ▶ Limit line and ripple check with configurable pass/fail indication
- ▶ Statistical trace analysis including maximum, minimum, RMS and peak-to-peak detection as well as compression point measurement
- ▶ Equation editor for complex trace mathematics

## Fast switching between instrument setups

Multiple setups are available simultaneously in the R&S®ZNB. This allows users to quickly switch between measurement tasks. This feature is especially helpful with DUTs that require different measurements. Users can maintain a better overview and control measurements more easily.

## An analyzer that speaks the user's language

Many tasks are easiest solved in one's native language. The R&S®ZNB therefore comes with a multilingual user interface. Currently available languages include Chinese, English, French, Japanese, Russian, and others. The R&S®ZNB also allows the remote control command set to be selected. It supports the remote control command sets

of practically all other Rohde&Schwarz network analyzers as well as those of other manufacturers' instruments. This makes it very easy to replace an obsolete analyzer with an R&S®ZNB or integrate an R&S®ZNB into existing systems.

## Several ways to arrive at the desired setup

### Conventional approach

Users can take the conventional approach to configure measurements on the R&S®ZNB. From various menus, they can select the parameters for a desired setup, e.g. power parameters, the number of points, and the measurement type and measurement quantity. However, complex test setups, e.g. for mixer or intermodulation measurements, require a vast number of parameters to be set carefully – a time-consuming and error-prone procedure. To enable users to configure even complex measurement tasks quickly and accurately, covering all the required parameters, the R&S®ZNB offers two alternatives.

### All-in-one dialogs – keeping track even of sophisticated setups

All-in-one dialogs for typical measurements such as intermodulation on mixers combine, in a single display, all key parameters otherwise distributed among several menus. The hardware is configured interactively using graphic elements. Test parameters such as frequencies, power levels

and bandwidths are set via pull-down menus and input fields. Users see all relevant information at a glance, not missing a single parameter. Measurement traces for any desired measurement quantities can then be dragged and dropped to any desired position.

### DUT-centric approach

With the DUT-centric approach, a wizard guides the user to the desired setup in a step-by-step procedure. Configuration focuses on the type of DUT to be characterized, i.e. all settings are made from the DUT's perspective. The user only needs to deal with parameters relevant for that specific DUT. In a first step, the user defines the type of DUT (e.g. a mixer) and its key data (e.g. maximum/minimum input power level and frequency ranges). Next, the wizard prompts the user to specify the connections between the DUT and the analyzer. In a final step, the user configures the measurement parameters, using DUT-specific terms (e.g. "Conversion Gain RF to IF" or "Feedthrough LO to IF"). On completion of the test setup, the analyzer checks the settings made and automatically creates the associated traces and channels. If desired, the user can complete the measurement configuration by adding system error correction, which is likewise executed step by step.

## DUT-centric measurement configuration

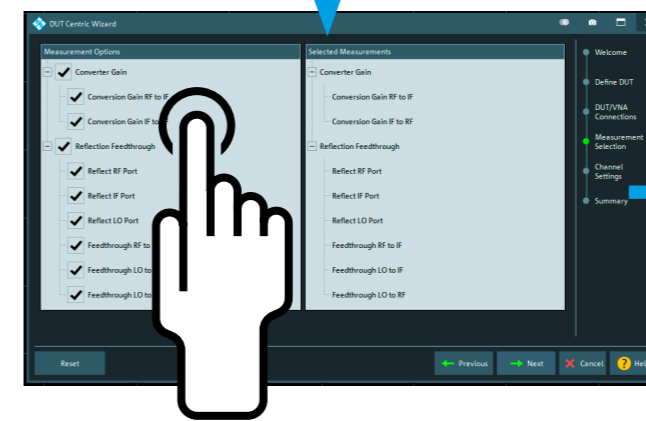
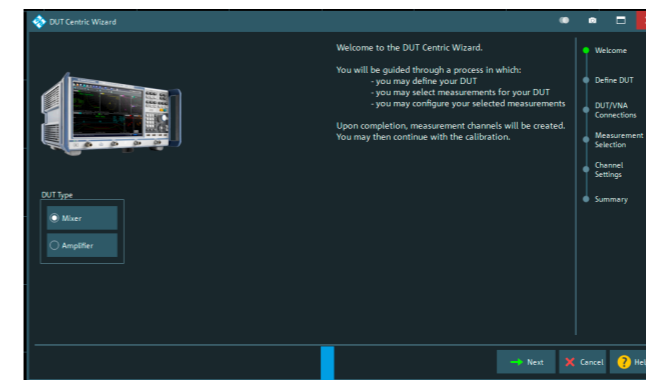

Based on the selected type of DUT, the wizard guides the user step by step to the desired measurement setup.

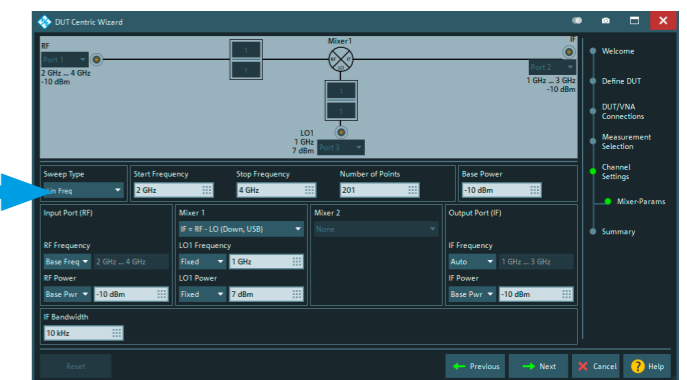

# HIGH THROUGHPUT IN PRODUCTION

The R&S®ZNB is especially suitable for use in production. It offers an optimum combination of speed, flexibility and performance.

## Short measurement times and large IF bandwidths

The R&S®ZNB features short measurement times. This is a result of the analyzer's large IF bandwidths, supporting sampling times shorter than 5 µs per point, and its fast synthesizer settling times. Other factors accelerating measurements are high-speed data processing up to the display and fast LAN or IEC/IEEE data transfer to the controller. As a result, the R&S®ZNB can perform a frequency sweep covering 401 points in a total measurement time of 4 ms.

## High measurement speed due to wide dynamic range and optimized IF bandwidths

Measurement speed for tests on high-rejection DUTs, such as base station duplex filters, is determined by the required dynamic range and the corresponding IF bandwidth. The R&S®ZNB offers a dynamic range of up to 140 dB for a 10 Hz IF bandwidth. For a sweep with

110 dB dynamic range covering 201 points, the R&S®ZNB requires less than 30 ms, a value that is attractive e.g. for base station filter manufacturers.

## R&S®ZRun software for production test automation

The R&S®ZRun VNA test automation suite ideally complements the R&S®ZNB in production applications. The software allows fast and easy execution and scaling of test sequences in production. The programmable plug-in interface can be used to integrate and control DUTs and external test equipment (e.g. parts handlers or barcode scanners).

R&S®ZRun is easy to adapt to special requirements and can be integrated into existing test sequences. It is ideal for use in high-speed, high-volume production of RF components.

Testing a frontend module with the R&S®ZNB, an R&S®ZN-Z84 switch matrix and an R&S®ZN-Z15 RFFE GPIO interface option (external box). The R&S®ZN-Z15 allows the module's MIPI® RFFE interface to be directly addressed by the R&S®ZNB firmware. The R&S®ZRun VNA test automation suite can be used to increase measurement throughput.

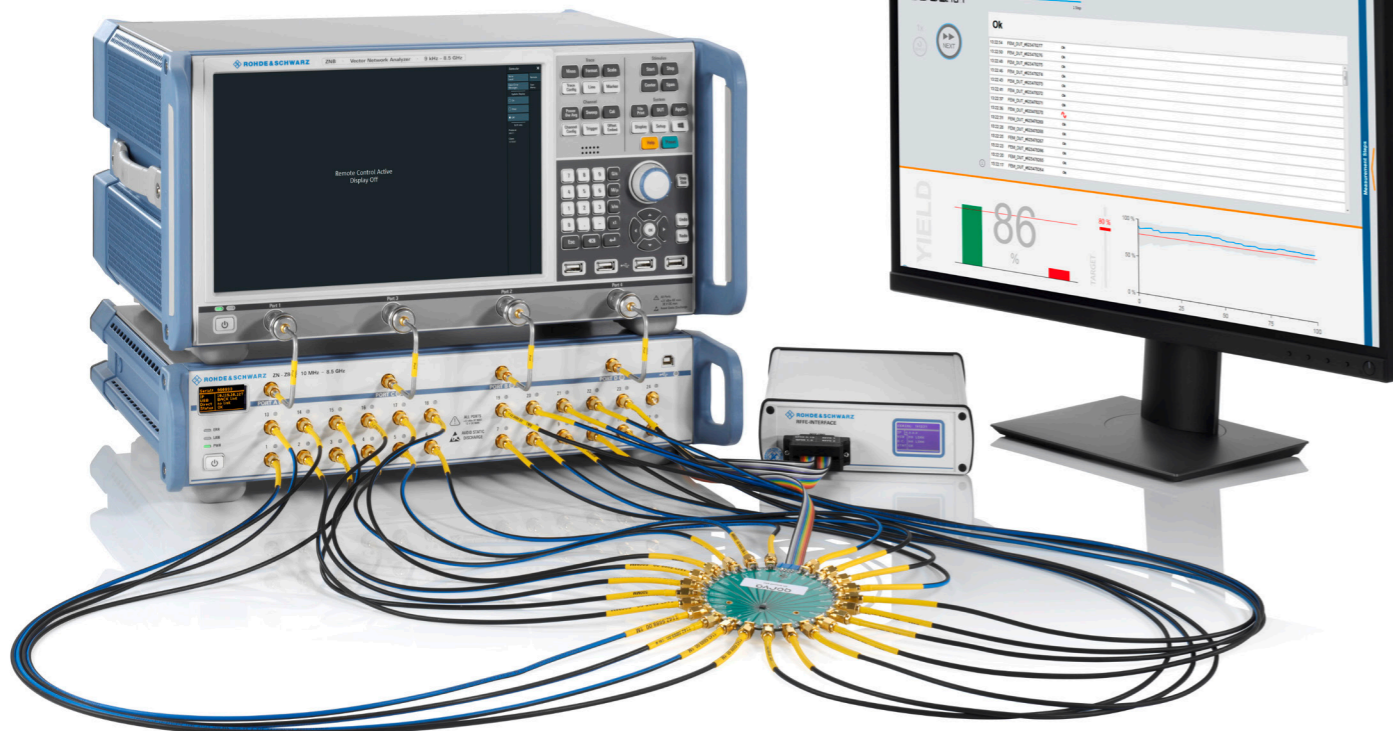

## Benefits offered by R&S®ZRun

- ▶ Control of multiple test stations with a single software suite
- ▶ Automatic speed optimization for test sequences
- ▶ Integration and control of DUTs and external test equipment via an extendable plug-in interface
- ▶ Fast and convenient measurement configuration focused on the DUT
- ▶ Visualization and comparison of results
- ▶ Graphical user interface for creating and optimizing test sequences

R&S®ZRun configurations are modular and reusable, which helps minimize reconfiguration time in case of modifications. Based on the configuration, R&S®ZRun calculates a connection plan optimized for speed. R&S®ZRun also calculates an initialization sequence, a calibration plan and a speed-optimized test plan.

## Convenient health and utilization monitoring service (HUMS)

The health and utilization monitoring service (HUMS) software option is available for the R&S®ZNB to allow improved monitoring of the instrument utilization, status and health. Along with this data, the HUMS option shows further information, e.g. about the operating system and security patches installed on the R&S®ZNB. The HUMS option can be used on production lines to optimize overall utilization and minimize downtime.

## RFFE module tests with direct control via RFFE GPIO interface

A growing number of components such as filters, switches and amplifiers need to be integrated into the frontend modules of mobile devices such as smartphones and tablets and need to communicate with each other. Here, the RFFE bus defined by the MIPI® Alliance has established itself as the de facto standard. The optional R&S®ZN-Z15 RFFE GPIO interface (external box) allows RF frontend modules in mobile devices to be directly controlled by the R&S®ZNB in order to carry out measurements with the modules set to diverse operating modes. The R&S®ZN-Z15 interface can also be used to perform current and voltage measurements on the DUT.

## Handler I/O interface for communication with external parts handlers

Via the optional R&S®ZN-B14 handler I/O interface, the R&S®ZNB can communicate with an external parts handler. During a typical test cycle, a parts handler places the DUT into a holder and sends the start signal for the measurement. On completion of the measurement, the parts handler removes the DUT from the holder and sorts it according to predefined criteria. Then the handler places a new DUT in the holder, and the test cycle starts again. The R&S®ZNB can thus be used for the fast and reliable execution of automated tests, which play a key role especially in production applications.

Easy configuration of an antenna switching module using the external R&S®ZN-Z15 RFFE GPIO interface and the RFFE configuration menu.

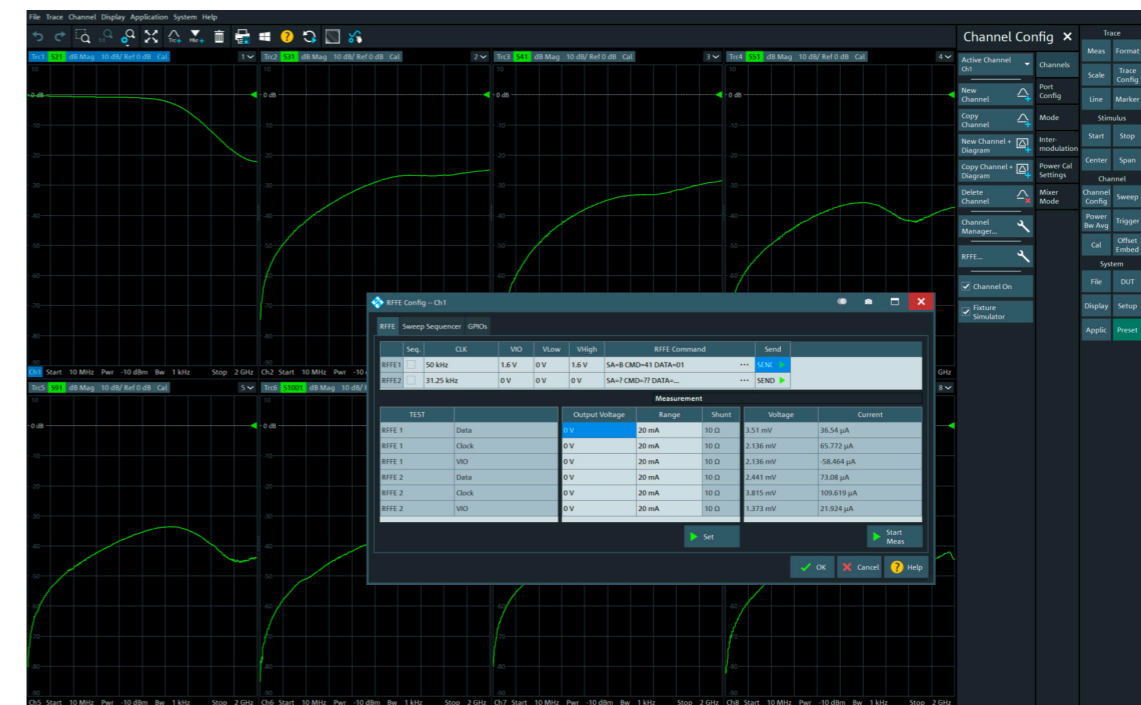



# CALIBRATION MADE EASY

Along with classic Through, Open, Short, Match (TOSM) calibration for coaxial applications, the R&S®ZNB also supports various calibration methods for on-wafer applications and waveguide measurements.

## Full calibration with only three standards – faster, simpler, more accurate

- ▶ Through, Reflect, Line/Line, Reflect, Line (TRL/LRL) for on-wafer applications, waveguides and coaxial DUTs
- ▶ Through, Reflect, Match (TRM) for applications in test fixtures, on wafers and in waveguide environments
- ▶ Through, Short, Match (TSM) and Through, Open, Match (TOM) as alternatives to TOSM for reduced calibration effort, providing the same accuracy

## Calibration for DUTs using a mix of connectors

The classic TOSM method does not support direct calibration of test setups for DUTs equipped with different types of connectors at the input and output. The R&S®ZNB offers two alternatives to provide the desired calibration: the Unknown Through, Open, Short, Match (UOSM) method and the adapter removal method.

**UOSM calibration** is the smartest way to overcome the above problem. A through connection with unknown parameters is required, i.e. a reciprocal (but otherwise more or less arbitrary) two-port device, e.g. a simple and cost-effective adapter. The effort is equivalent to that of the TOSM method.

As an alternative, the R&S®ZNB offers classic **adapter removal calibration**. This method is very robust but involves considerably more calibration steps.



R&S®ZN-Z1xx  
economy calibration kits.



R&S®ZV-Z210 and R&S®ZV-WR10  
high-end calibration kits.



R&S®ZV-Z2xx and R&S®ZN-Z2xx  
high-end calibration kits.

## Calibration equipment

The **economy calibration kits** of the R&S®ZN-Z1xx series provide robust operation up to 40 GHz.

The **high-end calibration kits** of the R&S®ZV-Z2xx and R&S®ZN-Z2xx series include calibration standards from type N through 1.0 mm (110 GHz). These kits achieve very high calibration accuracy thanks to precision manufacturing combined with S-parameter based characterization of the individual calibration standards.

**Automatic calibration units** up to 67 GHz with two or four ports greatly simplify calibration, while reducing operator errors and improving calibration repeatability.

## Inline calibration units

The R&S®ZN-Z32 and R&S®ZN-Z33 inline calibration units support applications such as precise and dependable testing of satellite components in thermal vacuum chambers (TVAC) and testing of multiport components on production lines. The R&S®ZN-Z32 inline calibration unit covers the frequency range from 10 MHz to 8.5 GHz and can be used at temperatures from +5°C to +40°C. The R&S®ZN-Z33 inline calibration unit comes in two models, both covering the frequency range from 10 MHz to 40 GHz. One model operates at temperatures from +5°C to +40°C; the second model (TVAC model) can withstand temperatures from -30°C to +80°C. The inline calibration units are controlled over the CAN bus by the R&S®ZN-Z30 inline calibration unit controller, which supports up to 48 units.

Selection of calibration methods on the R&S®ZNB.

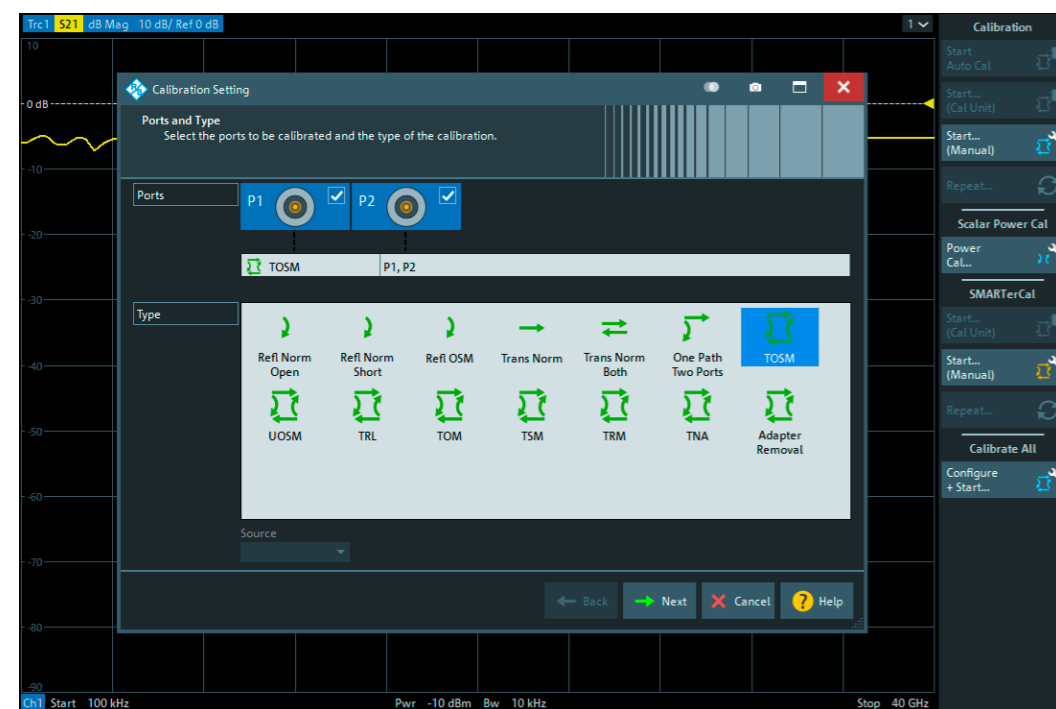

R&S®ZN-Z52  
automatic calibration unit.



R&S®ZN-Z32  
inline calibration unit.



R&S®ZN-Z33  
inline calibration unit.



Testing of USB cables with deembedding software algorithms.

### Deembedding test fixtures with the R&S®ZNB

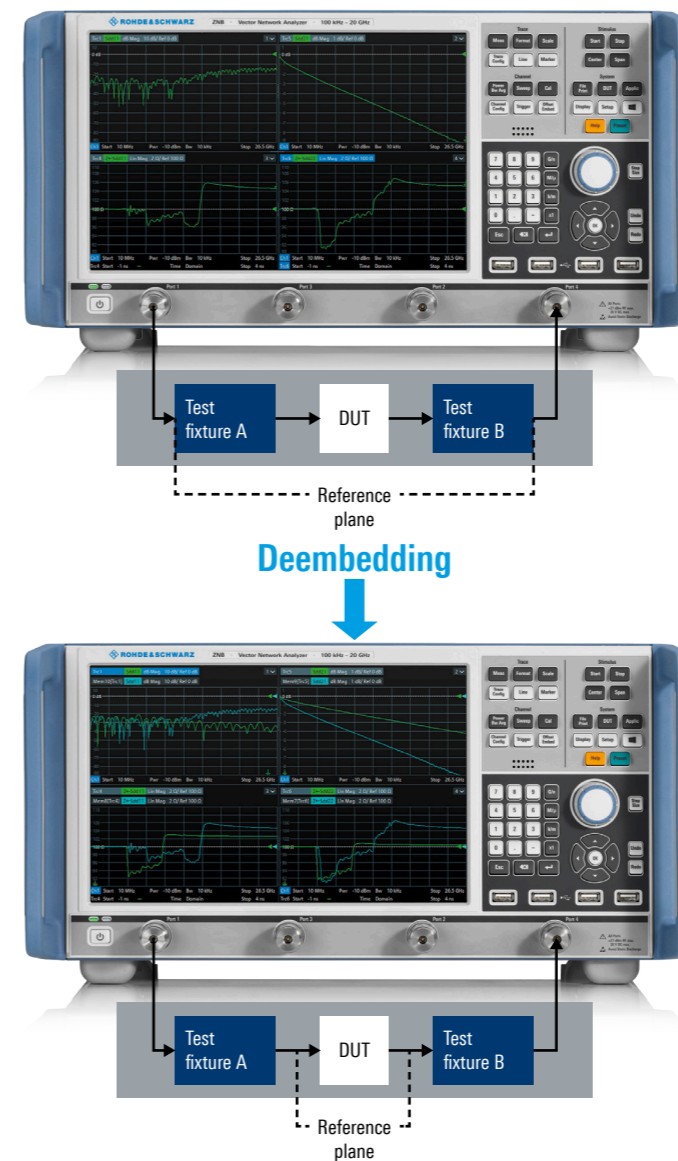

### High-quality deembedding using efficient software algorithms

Devices that do not have coaxial connectors can be installed in test fixtures to create a coaxial environment. To remove the effects of test fixtures whose S-parameters are not known, the R&S®ZNB provides various optional enhanced deembedding procedures. They allow characterizing the test fixture, extracting the S-parameters, and deembedding the test fixture in a convenient manner.

The deembedding algorithms supported by the R&S®ZNB are industry-recognized techniques in line with IEEE P370. They include in-situ deembedding (ISD, R&S®ZNB-K220), smart fixture deembedding (SFD, R&S®ZNB-K230) and EaZy deembedding (EZD, R&S®ZNB-K210).

The easy-to-use deembedding options are fully integrated into the R&S®ZNB user interface. The software guides the user quickly and effectively through the required measurement steps. The S-parameters extracted from test fixtures for the purpose of deembedding need not be exported or imported – a major advantage of this integrated solution.

#### Advantages

- ▶ Easy, test fixture corrected DUT characterization – even when non-coaxial connections are used for testing
- ▶ Accurate test fixture deembedding, handling different impedance planes
- ▶ Suitable for high frequencies
- ▶ S-parameter extraction from test fixtures
- ▶ Easy operation due to integrated user guidance

# EMBEDDING/DEEMBEDDING FOR A DIVERSE RANGE OF TEST FIXTURES

The R&S®ZNB supports various embedding/deembedding techniques that can be used to remove the effects of different test fixtures and precisely characterize the DUT.

### Embedding and deembedding known networks

On the R&S®ZNB, it is possible to add virtual matching networks or remove existing, known networks. Touchstone .s2p, .s4p, .s6p and .s8p files can be used for single-ended as well as differential configurations and multiport DUTs to remove test fixtures (deembedding) or to virtually install the DUT into a matching network (embedding).

Alternatively, the R&S®ZNB offers a choice of predefined, configurable 2-port and multiport matching networks that can be applied to characterize the DUT matched to the impedance of its targeted operating environment.

Workflow support: extremely easy operation with integrated user guidance.

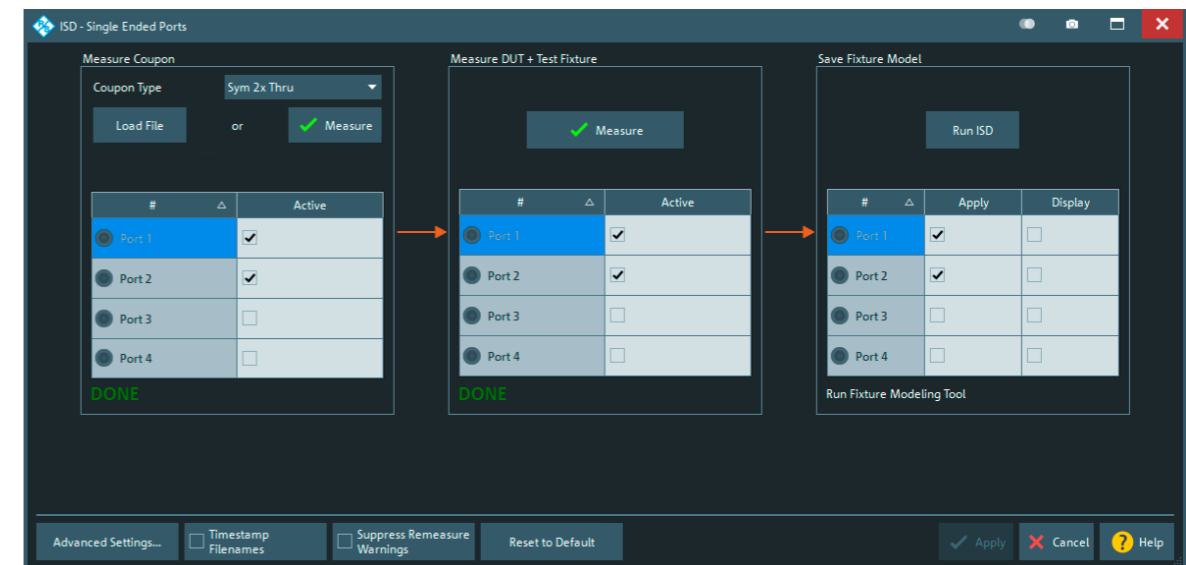

# REAL-TIME MEASUREMENT UNCERTAINTY ANALYSIS

The R&S®ZNB is a very precise instrument that can be used in microwave labs as well as on production lines. For both types of applications, knowing the actual uncertainty under given test conditions is crucial. The R&S®ZNB-K50(P) measurement uncertainty analysis option provides real-time display of the measurement uncertainty along with traceable uncertainty calculation.

Until now, calculating measurement uncertainty for a DUT's S-parameter results was possible only in a metrology lab. But now, thanks to the R&S®ZNB-K50(P) option, the R&S®ZNB can perform this calculation on its own. R&S®ZNB-K50(P) was developed in cooperation with METAS, the Swiss Federal Institute of Metrology. The option automatically calculates the measurement uncertainty bands and displays them along with the measured S-parameters. This allows users to keep track of the measurement uncertainty at a glance.

The R&S®ZNB-K50(P) option can also be used to perform verification tests. In this case, the characterization data for the verification kit is compared to the results measured by the R&S®ZNB for the verification kit.

In combination with the METAS VNA Tools software installed on the R&S®ZNB, this verification test is just as easy as calibration. After selecting the desired verification kit, the user is guided by the R&S®ZNB through the verification test. The procedure includes the creation of a test archive that contains an uncertainty database for the test setup along with raw measurement results and calibrated measurement results.

Verification kits are needed in order to evaluate the uncertainty of measurement results. Rohde & Schwarz offers verification kits up to 50 GHz (e.g. the R&S®ZV-Z435, a 3.5 mm verification kit up to 26.5 GHz). These kits contain verification standards that are accredited by Germany's national accreditation body (DAkkS).



Real-time S-parameter measurements with uncertainty bands.



Verification standards in the R&S®ZV-Z435 3.5 mm verification kit.

# APPLICATIONS

The R&S®ZNB supports a wide range of applications. The time domain option makes it possible to perform signal integrity measurements or validate EMC test sites. Measurements on active and passive components can be efficiently set up via intuitive configuration menus and with the use of wizards. The R&S®ZNB in combination with R&S®ZN-Z8x switch matrices delivers multiport measurements on up to 48 ports.

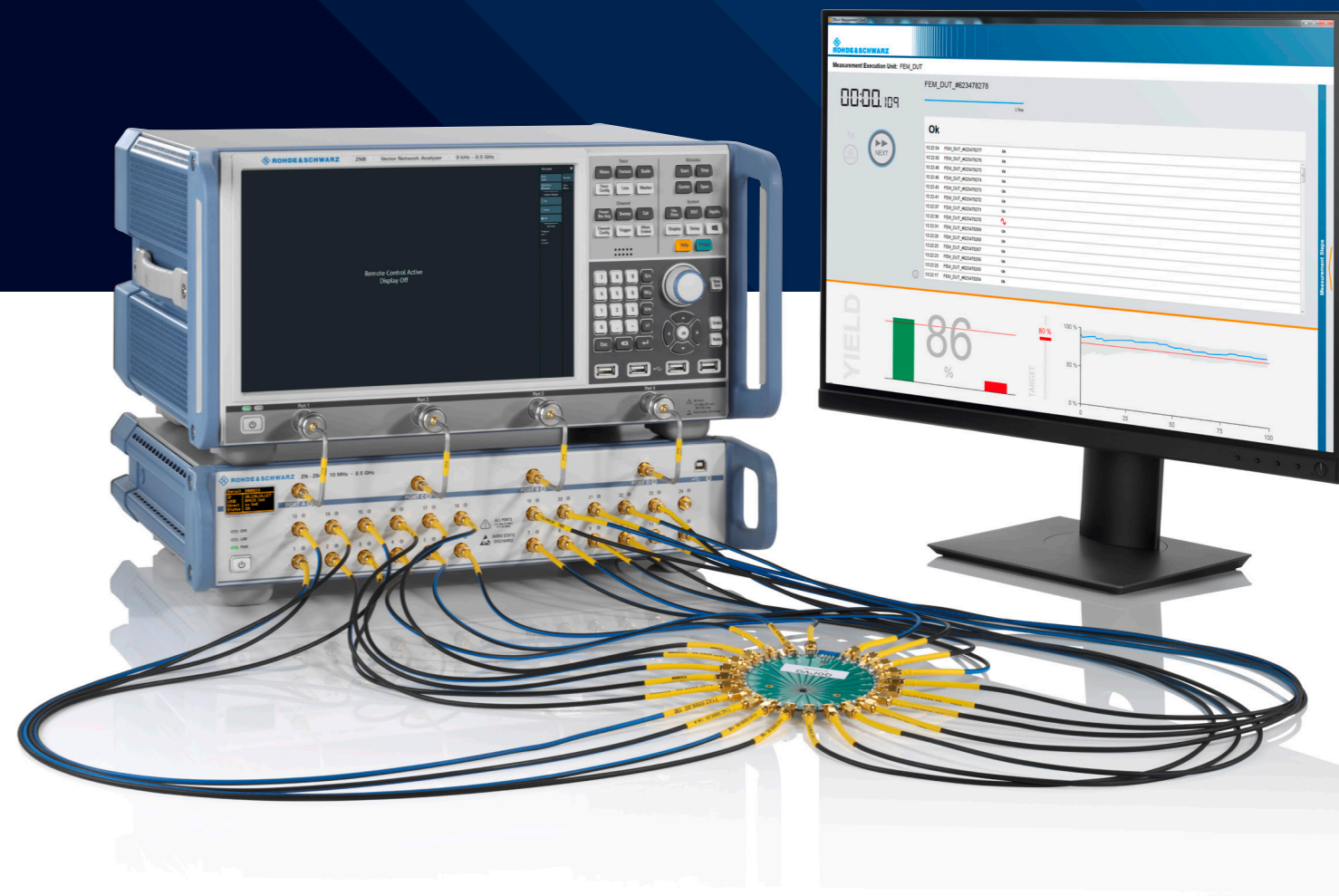

# TIME DOMAIN ANALYSIS AND SIGNAL INTEGRITY MEASUREMENTS

The R&S®ZNB provides powerful time domain analysis.

## Efficient time domain analysis with enhanced resolution

The R&S®ZNB supports powerful time domain analysis on components such as test fixtures, cables and connectors. With up to 100000 test points per trace, even electrically long DUTs such as cables can easily be tested. They can be analyzed by displaying the impedance versus length. The gating function allows the R&S®ZNB to isolate or mask discontinuities.

A 4-port R&S®ZNB can be used to measure the balanced S-parameters and other parameters such as near-end and far-end crosstalk (NEXT, FEXT) on two-wire lines and differential structures.

Using prediction, the frequency range of the R&S®ZNB can be virtually extended. This yields temporal and spatial resolution substantially higher than would be expected from the DUT's or analyzer's frequency range.

## Generation of eye diagrams

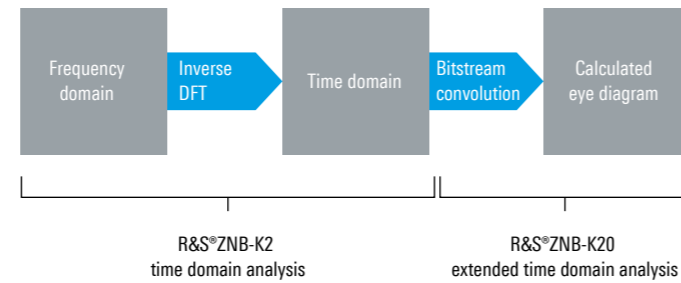

## Signal integrity at a glance with eye diagrams

The R&S®ZNB provides comprehensive analysis of cables and connectors in the time and frequency domains. The R&S®ZNB-K20 extended time domain analysis option makes it possible, based on the S-parameters, to calculate and display the rise time, skew and eye diagrams for different bit patterns, revealing the transmission quality at a glance. The R&S®ZNB-K2 time domain analysis and the R&S®ZNB-K20 extended time domain analysis options are integrated in the analyzer firmware. Eye diagrams and S-parameters versus frequency and time can be analyzed and displayed simultaneously.

## Analysis of disturbance effects and signal quality optimization

The R&S®ZNB-K20 extended time domain analysis option makes it possible to simulate the effects of disturbances such as jitter and noise on the eye diagram. The analyzer can also simulate the impact of correction algorithms such as preemphasis at the transmitter end and equalization at the receiver end. User-defined mask tests can also be configured.

## Distance-to-fault measurements

The R&S®ZNB-K3 distance-to-fault option can be used to locate discontinuities in cables. Discontinuities cause peaks in the impulse response, which are easy to display and analyze using the R&S®ZNB-K3 option. The option comes with a choice of predefined cable types with their typical properties.

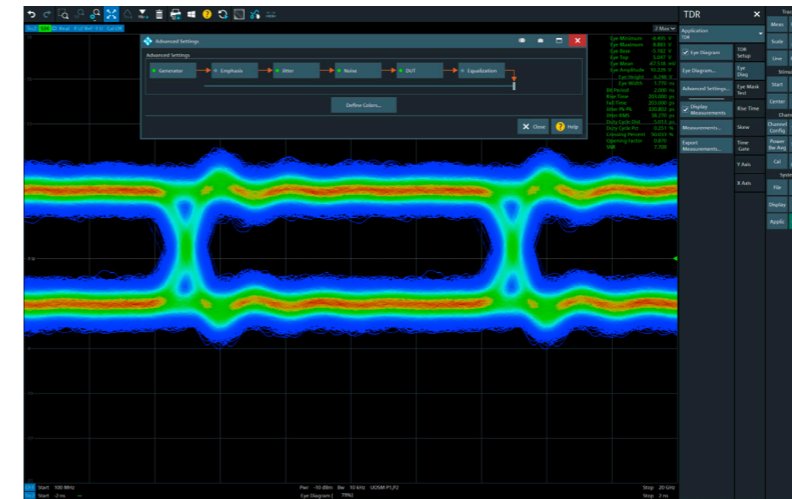

Simulation of the effects of various disturbances such as jitter and noise on the eye diagram.

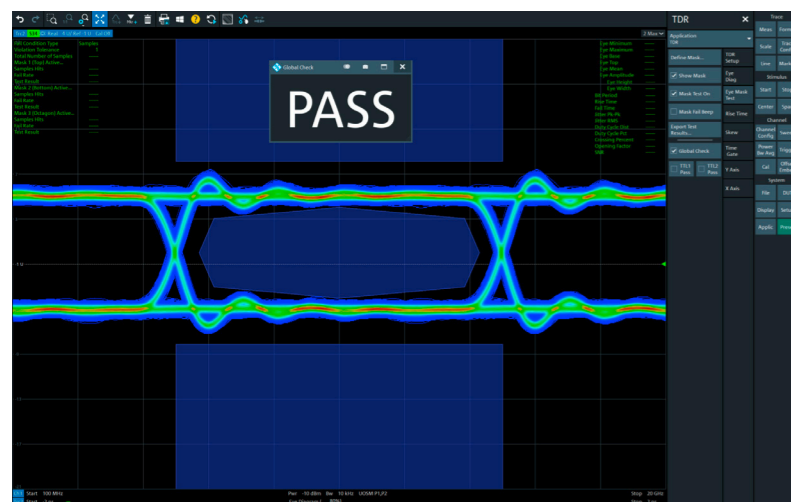

Eye diagram with limit mask and pass/fail evaluation.

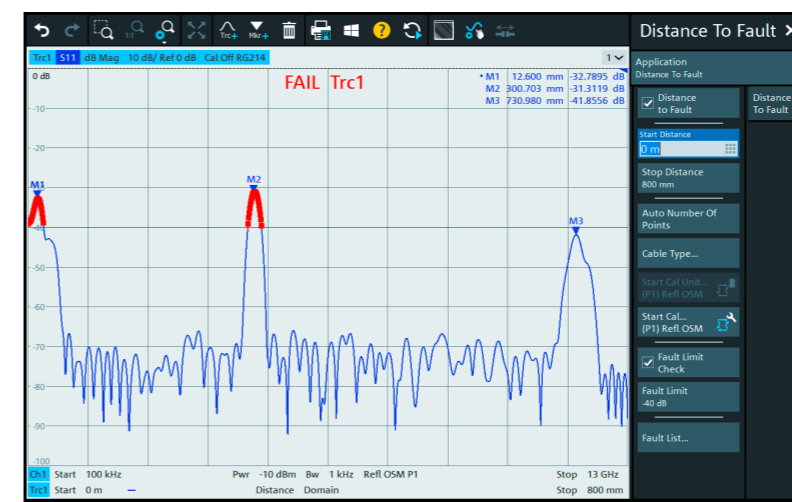

Reflections on a cable terminated with 40 dB. Marker M3 indicates the total cable length (73 cm). Marker M2 shows the distance to the fault (30 cm). Marker M1 represents the impedance matching of the connector.

# FAST EMC TEST SITE VALIDATION

Fully anechoic rooms (FAR) intended for EMC compliance measurements that rely on free space conditions need to be validated in order to verify that the acceptance criterion for these measurements is met. The R&S®ZNB with time domain analysis capability solves this task fast and with high precision.

## TD $S_{VSWR}$ calculation

$$TD S_{VSWR} = \frac{1+r}{1-r} = \frac{1 + \frac{S_{21}(f)}{S_{11}(f)}}{1 - \frac{S_{21}(f)}{S_{11}(f)}}$$

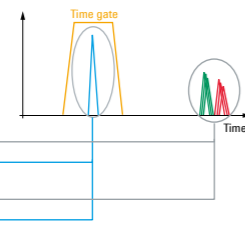

The time domain site VSWR (TD  $S_{VSWR}$ ) measurement in line with ANSI C63.25 is a fast and precise method for validating fully anechoic rooms (FAR). It involves a series of impulse response measurements, which are performed by a 2-port R&S®ZNB20 or R&S®ZNB26 equipped with the R&S®ZNB-K2 option, plus an R&S®HF907 double-ridged waveguide horn antenna. The R&S®ZNRUN software can be used to automate the test sequence.

In addition to demonstrating compliance with the site VSWR requirements, the TD  $S_{VSWR}$  method delivers other valuable information. For example, the impulse response results displayed in the time domain analysis view can be used to identify areas in a FAR where additional or better quality absorbers are needed.

The antenna impulse response in ideal free space would consist of a single pulse (direct antenna-to-antenna impulse response). However, since measurements are normally made in a test chamber and not in ideal free space, the TD  $S_{VSWR}$  method can also be used to identify undesired reflections here. These reflections can be separated from the direct antenna impulse response using time gating in order to calculate the TD  $S_{VSWR}$ .

## TD $S_{VSWR}$ measurements with a vector network analyzer

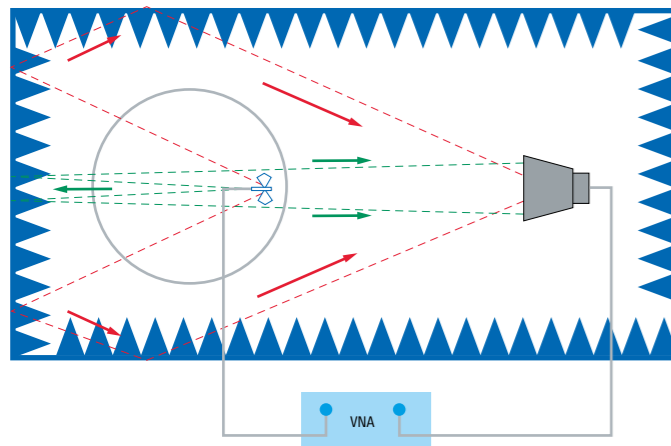

R&S®ZNB20 equipped with the R&S®ZNB-K2 time domain analysis option, together with an R&S®HF907 double-ridged waveguide horn antenna, provides an ideal solution for fast and accurate site validation measurements using the TD  $S_{VSWR}$  method in line with ANSI C63.25.

# FILTER MEASUREMENTS

The R&S®ZNB has many characteristics that are useful when testing filters. These include a wide dynamic range, fast measurement speed and diverse analysis capabilities.

## Segmented sweep tailored to the device under test

Testing high-rejection DUTs such as duplex filters for repeaters requires large IF bandwidths in the passband to ensure short measurement times. In the stopband, however, high output power levels and narrow IF bandwidths are needed to provide the required dynamic range. The analyzer's segmented sweep function divides the frequency axis into segments. The output power, IF bandwidth and number of test points can be separately defined for each segment to optimally match the sweep to the DUT characteristics. This increases measurement speed without any loss in accuracy.

## Investigating bandpass filters

Markers can be used to display the key parameters for a bandpass filter. In the marker menu under "Band filter", the R&S®ZNB offers various options to define the reference marker for filter analysis. Once this marker has been set, the analyzer displays the key parameter values, e.g. for the bandwidth and center frequency.

## Filter tuning and fast pass/fail analysis

It is often necessary to test filters for compliance with limit values and tune the filters as required. The R&S®ZNB has various support functions that quickly reveal whether a filter is within tolerance limits after tuning. For example, limit lines can be inserted and limit checks applied for a fast and clear indication of whether a DUT satisfies requirements.

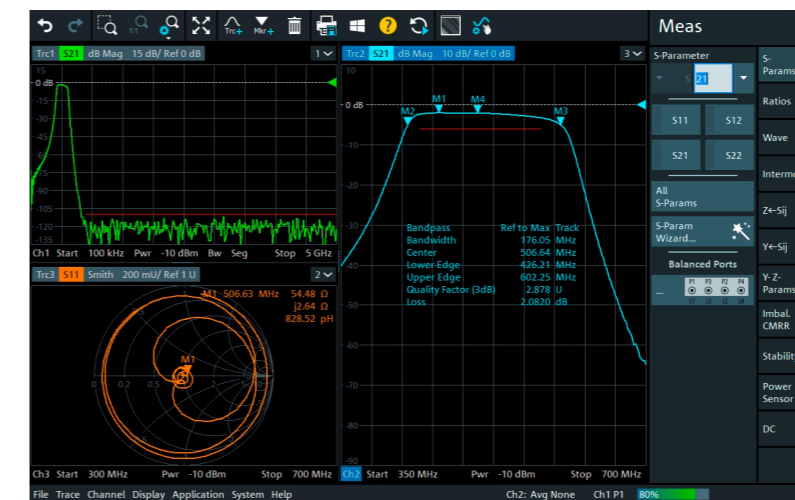

Characterization of a bandpass filter. The values for the key parameters are displayed.

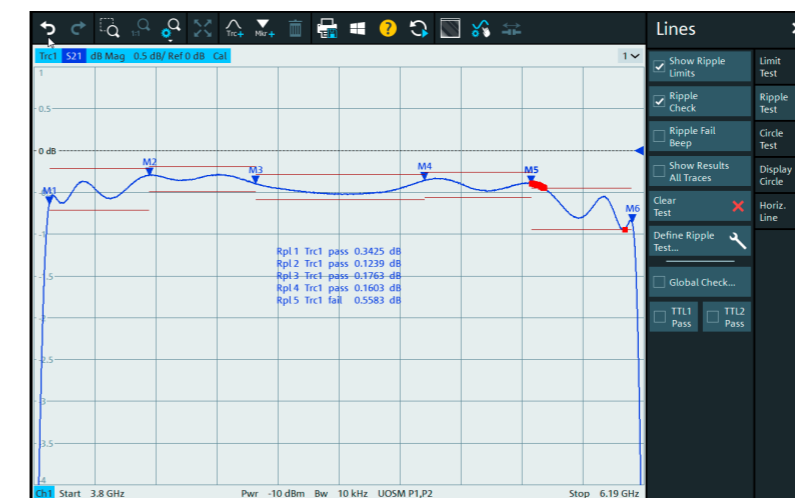

Ripple test in the passband of a bandpass filter with limit lines and pass/fail indications.

# MEASUREMENTS ON UP TO 48 PORTS

The R&S®ZNB in combination with various switch matrices provides a comprehensive solution for complex measurements on modules with up to 48 ports.

## Expanding the number of ports with switch matrices

Components used in modern communications equipment, e.g. frontend modules in smartphones and tablets, support a growing number of frequency bands as well as other functions such as WLAN, Bluetooth®, GPS and mobile communications. As a result, the number of RF ports on

these modules is also growing, not least due to the use of differential components. The R&S®ZNB in combination with various switch matrices provides a comprehensive solution for complex measurements on modules with up to 48 ports. The matrices from Rohde&Schwarz support full crossbar measurements, allowing all S-parameters of a multiport DUT to be determined.

## Easy configuration at the push of a button

The R&S®ZNB controls the switch matrices via LAN, USB or a dedicated digital device control interface (R&S®ZNB-B12 option). With an R&S®ZNB8 4-port model, for example, two switch matrices with two input ports and 24 output ports each can be combined to characterize DUTs with up to 48 ports. Once a matrix is connected, the analyzer automatically detects the matrix type and allocates the ports so that users can immediately start measuring. S-parameters, waves and wave ratios are directly selected and displayed on the R&S®ZNB user interface.

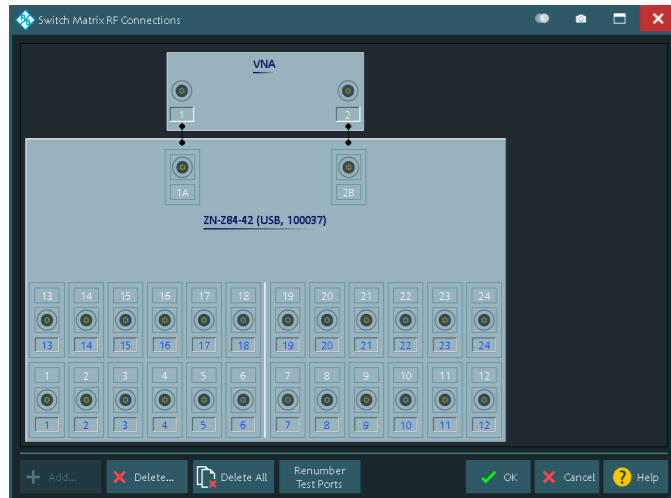

Automatic allocation of ports in the R&S®ZNB.



R&S®ZNB with two R&S®ZN-Z84 switch matrices.

## Mixed configuration with matrix and standard VNA ports

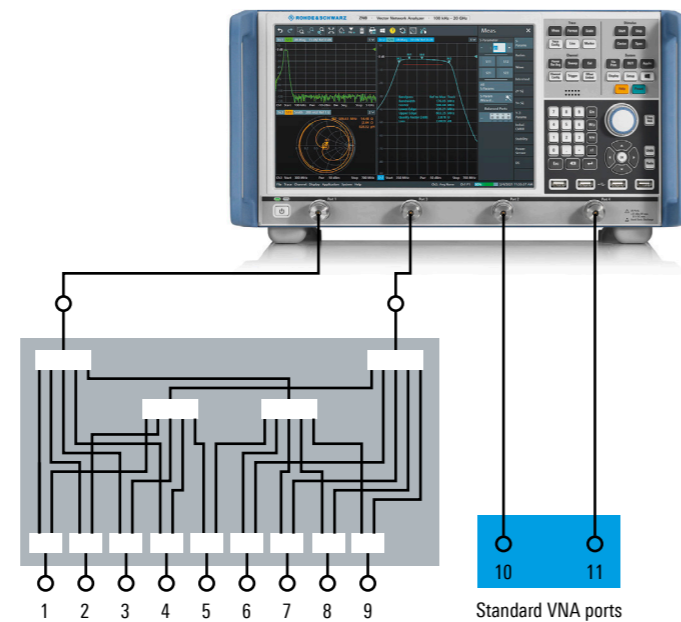

## Fast measurements and excellent RF characteristics

Switch matrices from Rohde&Schwarz feature exceptionally short switching times. Via a dedicated device control interface (R&S®ZNB-B12 option), the R&S®ZNB controls the matrix switches directly and synchronously with its internal test sequences. This speeds up measurements, especially for sweeps covering a small number of points.

Featuring a compact design and state-of-the-art electronic switches, the R&S®ZN-Z84 and R&S®ZN-Z85 switch matrices exhibit low insertion loss. Other highlights include good test port matching and a high compression point, allowing measurements on active DUTs with output power levels up to +20 dBm.

Rohde&Schwarz offers calibration units with up to 24 ports (e.g. R&S®ZN-Z154). These enable fast, automated calibration of the R&S®ZNB together with the matrices connected to it.

## Matrix solutions for every application

Rohde&Schwarz offers switch matrices for a variety of applications. Matrix models with two or four inputs and up to 24 outputs are available, allowing users to strike the optimal balance between low insertion loss, maximum accuracy and a large number of ports. The R&S®ZN-Z84 and R&S®ZN-Z85 base units each come with six outputs. The R&S®ZN-Z84 switch matrix can be expanded to offer up to 24 outputs by adding further ports in groups of six. The R&S®ZN-Z84 covers the frequency range from 10 MHz to 8.5 GHz.

Multipoint measurements up to 20 GHz can be performed using an R&S®ZN-Z85 switch matrix together with an R&S®ZNB20 analyzer. The R&S®ZN-Z85 is available with two inputs and six outputs or with four inputs and 12 outputs.

It is also possible to combine a 4-port R&S®ZNB with a matrix with two inputs (mixed configuration). The remaining two ports can be used as regular VNA ports (standard VNA ports) offering the outstanding performance the R&S®ZNB is known for.

## R&S®ZN-Z84 or R&S®ZN-Z85 with 12 outputs for 4-port R&S®ZNB

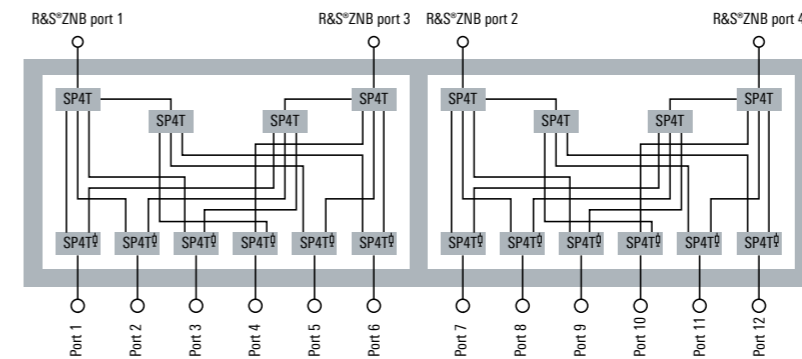

R&S®ZN-Z154 24-port calibration unit.

## R&S®ZN-Z84 with 24 outputs for 2-port R&S®ZNB

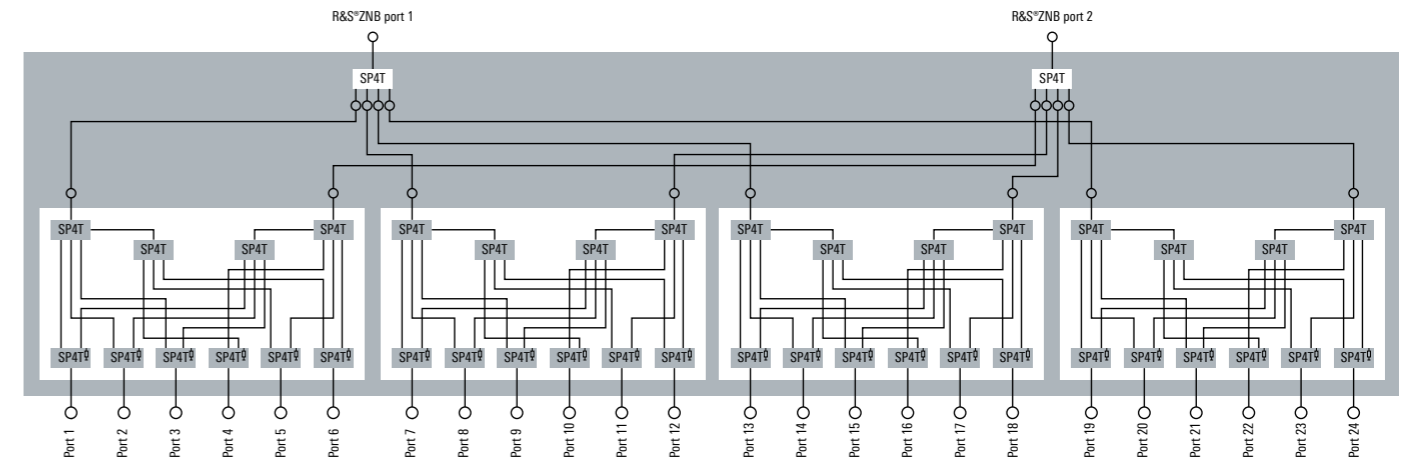

# MEASUREMENTS ON AMPLIFIERS AND MIXERS

The R&S®ZNB is well suited for testing passive, active and frequency-converting components. It offers a variety of functions for these measurements, including a second internal source, a wide power sweep range and intuitive measurement configuration.

## Wide dynamic range for challenging intermodulation measurements

The R&S®ZNB offers major benefits especially when testing amplifiers with very small intermodulation products. Its wide dynamic range and the excellent power handling capacity of its receivers make it possible to measure low intermodulation distortion within seconds instead of minutes.

Wizard-assisted configuration of an intermodulation measurement.

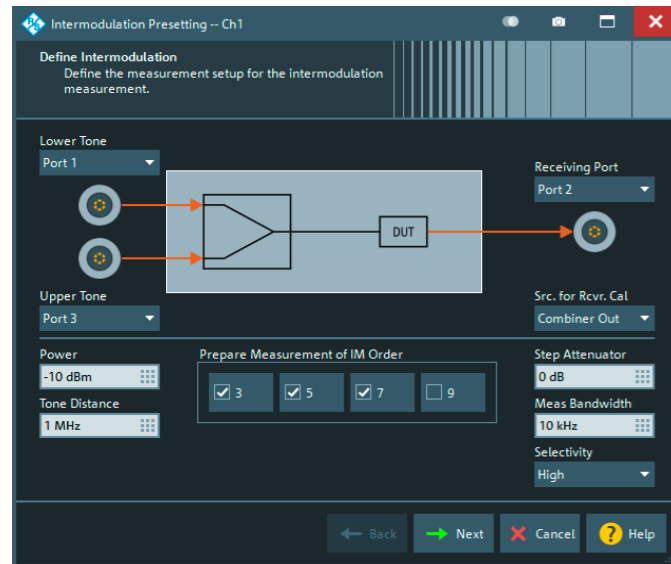

Configuring mixer measurements with a DUT-centric wizard.

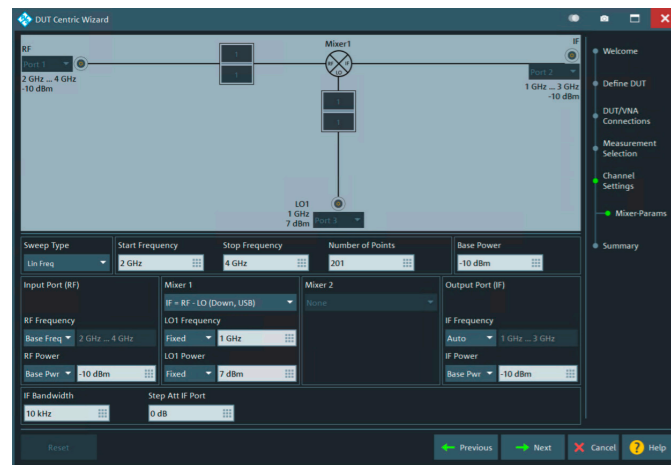

## Wizard-assisted measurement configuration

The R&S®ZNB supports users in various ways during measurement configuration. Tools such as an intermodulation wizard and a mixer wizard help to quickly configure the instrument setup for the intended measurements. A DUT-centric wizard is also available. It guides the user step by step to the desired setup, based on the type of DUT to be characterized.

## R&S®SMARTerCal – get ready for active device testing

Calibrating the absolute power levels of a network analyzer's sources and receivers is indispensable in order to reliably test amplifiers, mixers and T/R modules. However, this process is time-consuming. The R&S®ZNB offers a special calibration technique referred to as R&S®SMARTerCal, which radically simplifies calibration. R&S®SMARTerCal combines the information gained from system error correction (e.g. TOSM, UOSM) with the information obtained through absolute power level calibration (wave quantities in terms of amplitude and phase). This means that the absolute power levels of the sources and receivers are calibrated already during system error correction, taking into account port mismatch.

For absolute output power level calibration, a power sensor needs to be connected to only one test port only once. The calibration values for all other sources and receivers are derived from the calibration values for that specific test port. This significantly reduces calibration time and effort.

## Amplifier measurements with a wide power sweep range and receiver step attenuators

The wide, electronically adjustable power sweep range of the R&S®ZNB from -85 dBm to +13 dBm enables fast analysis of the linear and nonlinear characteristics of small- and large-signal amplifiers. Electronic step attenuators in the receive paths increase the 0.1 dB compression point to +27 dBm. The wear-free attenuators feature delay-free switching, which speeds up measurements and extends the useful life of the R&S®ZNB.

Additional features:

- ▶ Four DC inputs for measuring amplifier DC power consumption and efficiency
- ▶ Measurement of stability factors of balanced and unbalanced amplifiers
- ▶ Support of R&S®NRP-Zxx power sensors, providing high-precision power versus power and power versus frequency measurements

## Frequency-converting measurements on mixers and amplifiers – simple and fast with two independent internal sources

When equipped with the R&S®ZNB-K4 frequency conversion and R&S®ZNB-K14 intermodulation measurements options, the R&S®ZNB can measure harmonics and intermodulation products on amplifiers as well as conversion loss, matching and isolation on mixers versus frequency and power. A special calibration technique – R&S®SMARTerCal – combines absolute power calibration

with system error correction, enabling the precise determination of the magnitude of mixer conversion loss. Wizards guide the user step by step to the desired measurement configuration and through calibration. For complex measurements, e.g. on frontends with multiple mixer stages, the R&S®ZNB can control multiple external signal generators via LAN or IEC/IEEE bus.

The R&S®ZNB 4-port models can optionally be equipped with a second, independent internal source. This source can be used, for example, as a local oscillator in mixer measurements or to generate two-tone signals in intermodulation measurements. This feature boosts measurement speed by a factor of up to 10 compared to setups using an external generator. Plus, it significantly simplifies the test setup.

## Compression point measurements

Determining the compression point is essential when characterizing amplifiers. To perform this measurement, the sweep mode is set to "Power" on the R&S®ZNB, and the compression point measurement can be started. The result is calculated automatically and displayed.

Performing a mixer measurement on the R&S®ZNB.



# TESTS IN VACUUM CHAMBERS AND ON MULTIPOINT DEVICES

The R&S®ZN-Z3x inline calibration units allow precise and reliable measurements even in scenarios where the user has no access to the reference plane. This is the case, for example, when performing satellite tests in thermal vacuum chambers (TVAC). The inline calibration units also enable highly efficient measurements on multipoint devices involving a large number of ports.

## TVAC (satellite) tests

When performing tests in a thermal vacuum chamber (TVAC), thermal drift effects in the test system components (e.g. RF cables, adapters, switches and preamplifiers) can render the original calibration invalid. The R&S®ZN-Z33 inline calibration units can remain connected at all times between the ends of the test cables and the DUT, allowing fast recalibration after each change in ambient temperature. Temperature characterization for the inline calibration units at the factory ensures accurate and dependable results in a range from -30°C to +80°C.

## Multipoint measurements

Connecting or reconnecting coaxial multipoint DUTs invariably involves moving the test cables. The limited phase stability of the cables can affect measurement accuracy. A phase change can occur when the cables are moved. Using an R&S®ZN-Z32 or R&S®ZN-Z33 inline calibration unit, selected groups of ports can be recalibrated at the touch of a button without having to reconnect the cables.

## Software support for Rohde & Schwarz inline calibration units

The R&S®ZNB software supports all Rohde & Schwarz inline calibration units. The user can see all of the required configuration steps at a glance on the R&S®ZNB GUI:

- ▶ Automatic detection of all connected inline calibration units as well as the R&S®ZN-Z30 inline calibration unit controller
- ▶ Performing a base calibration
- ▶ Performing a recalibration

## Fast, automatic recalibration, no reconnection of DUT cables

The R&S®ZN-Z32 and R&S®ZN-Z33 inline calibration units can remain connected between the ends of the test cables and the DUT at all times, enabling highly efficient recalibration. The R&S®ZNB automatically detects connected devices, here the R&S®ZN-Z30 inline calibration unit controller and the R&S®ZN-Z32 inline calibration units.



## Wizard guided test setup configuration

The R&S®ZNB guides the user through the calibration steps. For base calibration, steps 1 and 2 are required; all subsequent recalibrations require step 1 only. In the calibration menu, recalibration is started at the touch of a button.

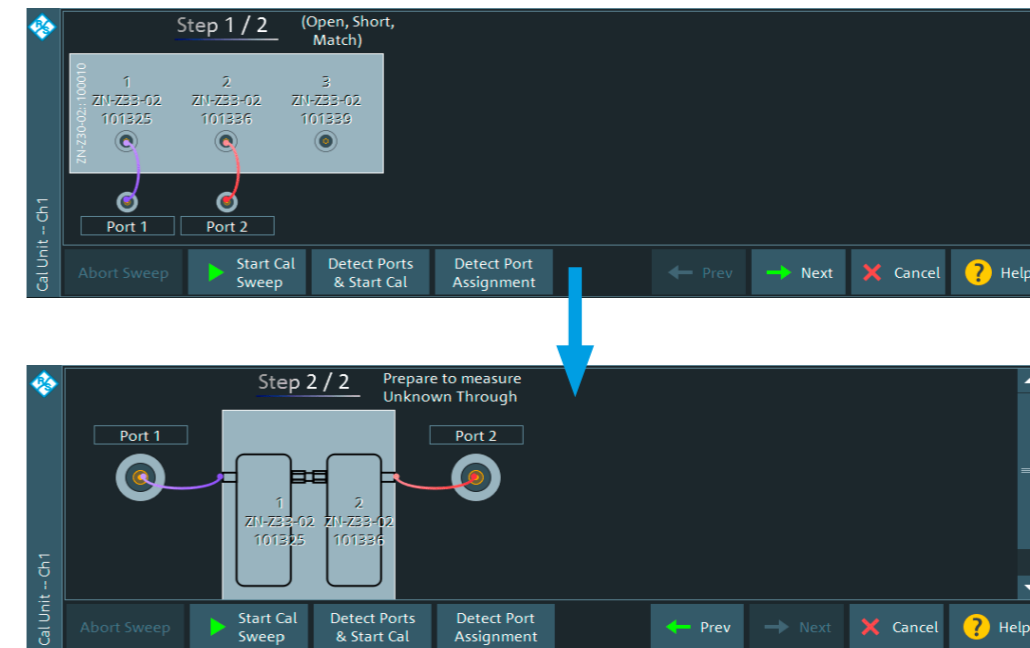

Example of a test setup with R&S®ZN-Z33 inline calibration units and an R&S®ZN-Z30 inline calibration unit controller connected to the R&S®ZNB.



# SPECIFICATIONS IN BRIEF

Specifications in brief		
Frequency range	R&S®ZNB4	9 kHz to 4.5 GHz
	R&S®ZNB8	9 kHz to 8.5 GHz
	R&S®ZNB20	100 kHz to 20 GHz
	R&S®ZNB26	100 kHz to 26.5 GHz
	R&S®ZNB43	100 kHz to 43.5 GHz
Number of ports		2 or 4
Dynamic range	R&S®ZNB4, R&S®ZNB8	up to 140 dB
	R&S®ZNB20	up to 135 dB
	R&S®ZNB26, R&S®ZNB43	128 dB
Trace noise	R&S®ZNB4, R&S®ZNB8	≤ 0.004 dB
	R&S®ZNB20, R&S®ZNB26, R&S®ZNB43	≤ 0.002 dB
Measurement time	R&S®ZNB8, 401 points; sweep mode: stepped; frequency range: 1 MHz to 8.5 GHz; IF bandwidth: 500 kHz; calibration: 2-port TOSM	13.2 ms
Output power	R&S®ZNB4, R&S®ZNB8, R&S®ZNB20	up to +15 dBm (typ.)
	R&S®ZNB26, R&S®ZNB43	up to +12 dBm (typ.)
Number of points		1 to 100001
Number of channels		> 100
Number of traces		> 100
Test parameters		<ul style="list-style-type: none"> <li>▶ S-parameters (single-ended, mixed-mode)</li> <li>▶ waves and wave ratios</li> <li>▶ <math>Z &lt; -S_{ij}</math>, <math>Y &lt; -S_{ij}</math>, Y/Z parameters</li> <li>▶ imbalance/CMRR</li> <li>▶ stability</li> <li>▶ power</li> </ul>
Software options	R&S®ZNB-K2	time domain analysis (TDR)
	R&S®ZNB-K3	distance to fault (DTF)
	R&S®ZNB-K20	extended time domain analysis
	R&S®ZNB-K4	frequency conversion
	R&S®ZNB-K14	intermodulation measurements
	R&S®ZNB-K17	10 MHz IF bandwidth
	R&S®ZNB-K19	1 mHz frequency resolution
	R&S®ZNB-K50	real-time measurement uncertainty analysis; requires VNA Tools software from METAS, the Swiss Federal Institute of Metrology (free download from METAS website)
	R&S®ZNB-K50P	real-time measurement uncertainty analysis with preinstalled VNA Tools software from METAS, the Swiss Federal Institute of Metrology
	R&S®ZNB-K210	EaZy deembedding (EZD)
R&S®ZNB-K220	in-situ deembedding (ISD)	
R&S®ZNB-K230	smart fixture deembedding (SFD)	
R&S®ZNB-K231	Delta-L 4.0 PCB characterization	
R&S®ZNB-K980	health and utilization monitoring service (HUMS)	
Calibration methods		reflect norm open, reflect norm short, reflect OSM, trans norm, one-path two-port, TOSM, UOSM, TRL, TOM, TSM, TRM, TNA, adapter removal
Switch matrices to expand the number of ports	R&S®ZN-Z84	up to 8.5 GHz, max. 2 units, up to 48 ports
	R&S®ZN-Z85	up to 20 GHz, max. 1 unit, up to 12 ports

Specifications in brief		
Languages		Chinese, English, French, German, Italian, Japanese, Korean, Russian, Spanish, and others
Dimensions	W × H × D	462.5 mm × 239.6 mm × 361.5 mm (18.2 in × 9.4 in × 14.2 in)
Weight	R&S®ZNB4, R&S®ZNB8, R&S®ZNB20, R&S®ZNB26, 2-port models	14 kg (31 lb)
	R&S®ZNB4, R&S®ZNB8, R&S®ZNB20, R&S®ZNB26, R&S®ZNB43, 4-port models	16 kg (35 lb)

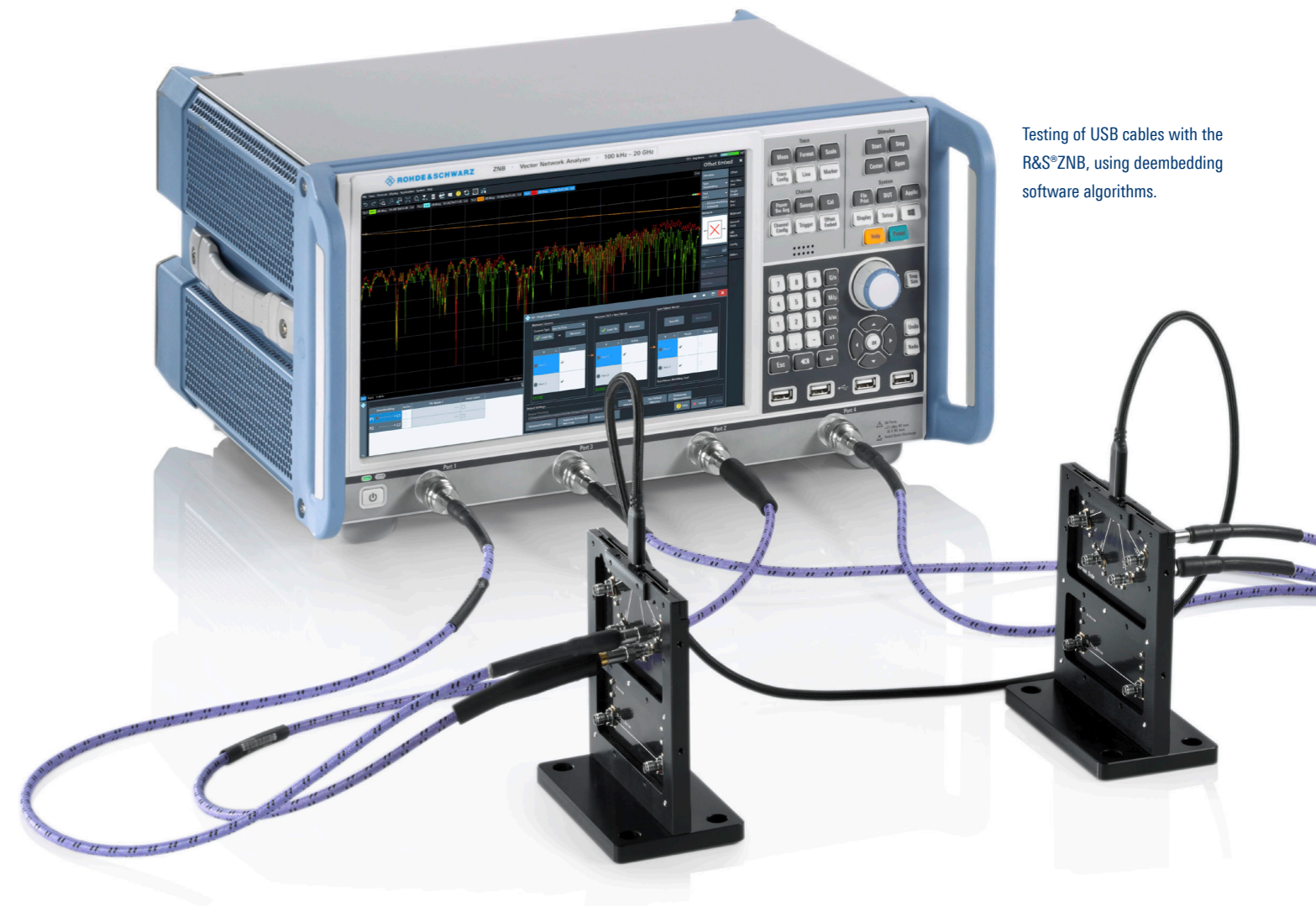

Testing of USB cables with the R&S®ZNB, using deembedding software algorithms.

# ORDERING INFORMATION

Designation	Type	Frequency range	Order No.
<b>Base units</b>			
Vector network analyzer, 2 ports, 4.5 GHz, N connectors	R&S®ZNB4	9 kHz to 4.5 GHz	1334.3330.22
Vector network analyzer, 4 ports, 4.5 GHz, N connectors	R&S®ZNB4	9 kHz to 4.5 GHz	1334.3330.24
Vector network analyzer, 2 ports, 8.5 GHz, N connectors	R&S®ZNB8	9 kHz to 8.5 GHz	1334.3330.42
Vector network analyzer, 4 ports, 8.5 GHz, N connectors	R&S®ZNB8	9 kHz to 8.5 GHz	1334.3330.44
Vector network analyzer, 2 ports, 20 GHz, 3.5 mm connectors	R&S®ZNB20	100 kHz to 20 GHz	1334.3330.62
Vector network analyzer, 4 ports, 20 GHz, 3.5 mm connectors	R&S®ZNB20	100 kHz to 20 GHz	1334.3330.64
Vector network analyzer, 2 ports, 26.5 GHz, 2.92 mm connectors	R&S®ZNB26	100 kHz to 26.5 GHz	1334.3330.63
Vector network analyzer, 4 ports, 26.5 GHz, 2.92 mm connectors	R&S®ZNB26	100 kHz to 26.5 GHz	1334.3330.65
Vector network analyzer, 2 ports, 43.5 GHz, 2.92 mm connectors	R&S®ZNB43	100 kHz to 43.5 GHz	1334.3330.92
Vector network analyzer, 2 ports, 43.5 GHz, 2.4 mm connectors	R&S®ZNB43	100 kHz to 43.5 GHz	1334.3330.93
Vector network analyzer, 4 ports, 43.5 GHz, 2.92 mm connectors	R&S®ZNB43	100 kHz to 43.5 GHz	1334.3330.94
Vector network analyzer, 4 ports, 43.5 GHz, 2.4 mm connectors	R&S®ZNB43	100 kHz to 43.5 GHz	1334.3330.95
<b>Hardware options</b>			
<b>Extended power range</b>			
Extended power range for 2-port R&S®ZNB4	R&S®ZNB4-B22	9 kHz to 4.5 GHz	1316.0210.02
Extended power range for 4-port R&S®ZNB4	R&S®ZNB4-B24	9 kHz to 4.5 GHz	1316.0233.02
Extended power range for 2-port R&S®ZNB8	R&S®ZNB8-B22	9 kHz to 8.5 GHz	1316.0227.02
Extended power range for 4-port R&S®ZNB8	R&S®ZNB8-B24	9 kHz to 8.5 GHz	1316.0240.02
Extended power range for 2-port R&S®ZNB20	R&S®ZNB20-B22	100 kHz to 20 GHz	1317.8950.02
Extended power range for 4-port R&S®ZNB20	R&S®ZNB20-B24	100 kHz to 20 GHz	1317.8967.02
Extended power range for 2-port R&S®ZNB26	R&S®ZNB26-B22	100 kHz to 26.5 GHz	1350.5457.02
Extended power range for 4-port R&S®ZNB26	R&S®ZNB26-B24	100 kHz to 26.5 GHz	1350.5463.02
Extended power range for 2-port R&S®ZNB43	R&S®ZNB43-B22	100 kHz to 43.5 GHz	1334.4320.02
Extended power range for 4-port R&S®ZNB43	R&S®ZNB43-B24	100 kHz to 43.5 GHz	1334.4337.02
<b>Receiver step attenuators</b>			
Receiver step attenuator, port 1, for R&S®ZNB4	R&S®ZNB4-B31	9 kHz to 4.5 GHz	1316.0185.02
Receiver step attenuator, port 2, for R&S®ZNB4	R&S®ZNB4-B32	9 kHz to 4.5 GHz	1316.0179.02
Receiver step attenuator, port 3, for R&S®ZNB4	R&S®ZNB4-B33	9 kHz to 4.5 GHz	1316.0262.02
Receiver step attenuator, port 4, for R&S®ZNB4	R&S®ZNB4-B34	9 kHz to 4.5 GHz	1316.0433.02
Receiver step attenuator, port 1, for R&S®ZNB8	R&S®ZNB8-B31	9 kHz to 8.5 GHz	1316.0191.02
Receiver step attenuator, port 2, for R&S®ZNB8	R&S®ZNB8-B32	9 kHz to 8.5 GHz	1316.0204.02
Receiver step attenuator, port 3, for R&S®ZNB8	R&S®ZNB8-B33	9 kHz to 8.5 GHz	1316.0162.02
Receiver step attenuator, port 4, for R&S®ZNB8	R&S®ZNB8-B34	9 kHz to 8.5 GHz	1316.0440.02
<b>Extended dynamic range</b>			
Extended dynamic range for 2-port R&S®ZNB4 <sup>1)</sup>	R&S®ZNB4-B52	9 kHz to 4.5 GHz	1319.4975.02
Extended dynamic range for 4-port R&S®ZNB4 <sup>1)</sup>	R&S®ZNB4-B54	9 kHz to 4.5 GHz	1319.4981.02
Extended dynamic range for 2-port R&S®ZNB8 <sup>1)</sup>	R&S®ZNB8-B52	9 kHz to 8.5 GHz	1319.4998.02
Extended dynamic range for 4-port R&S®ZNB8 <sup>1)</sup>	R&S®ZNB8-B54	9 kHz to 8.5 GHz	1319.5007.02
<b>2nd internal source</b>			
2nd internal source for 4-port R&S®ZNB4/R&S®ZNB8	R&S®ZNB-B2	9 kHz to 4.5/8.5 GHz	1317.7954.02
2nd internal source for 4-port R&S®ZNB20	R&S®ZNB20-B2	100 kHz to 20 GHz	1317.8980.02
2nd internal source for 4-port R&S®ZNB26	R&S®ZNB26-B2	100 kHz to 26.5 GHz	1350.5470.02
2nd internal source for 4-port R&S®ZNB43	R&S®ZNB43-B2	100 kHz to 43.5 GHz	1334.4343.02

<sup>1)</sup> Cannot be combined with R&S®ZNB-B1 or R&S®ZNB4-B3x/R&S®ZNB8-B3x.

Designation	Type	Frequency range	Order No.
<b>Further hardware options</b>			
Bias tees for 2-port R&S®ZNB4/R&S®ZNB8	R&S®ZNB-B1	100 kHz to 4.5/8.5 GHz	1316.1700.02
Bias tees for 4-port R&S®ZNB4/R&S®ZNB8	R&S®ZNB-B1	100 kHz to 4.5/8.5 GHz	1316.1700.04
Precision frequency reference (OCXO)	R&S®ZNB-B4		1316.1769.02
GPIO interface	R&S®ZNB-B10		1311.5995.04
Device control <sup>2)</sup>	R&S®ZNB-B12		1319.5088.02
Direct control cable <sup>2)</sup>	R&S®ZN-B121		1323.9290.00
Handler I/O (universal interface)	R&S®ZN-B14		1316.2459.05
External RFFE GPIO interface	R&S®ZN-Z15		1325.5905.02
External RFFE GPIO interface, including current and voltage measurements	R&S®ZN-Z15		1325.5905.03
DC inputs	R&S®ZNB-B81		1316.0004.02
<b>Software options</b>			
<b>Time domain analysis</b>			
Time domain analysis (TDR)	R&S®ZNB-K2		1316.0156.02
Extended time domain analysis <sup>3)</sup>	R&S®ZNB-K20		1326.8072.02
Distance to fault (DTF)	R&S®ZNB-K3		1350.5057.02
<b>Frequency-converting measurements</b>			
Frequency conversion <sup>4)</sup>	R&S®ZNB-K4		1316.2994.02
Intermodulation measurements <sup>5)</sup>	R&S®ZNB-K14		1317.8373.02
<b>Deembedding</b>			
EaZy deembedding (EZD)	R&S®ZNB-K210		1328.8592.02
In-situ deembedding (ISD)	R&S®ZNB-K220		1328.8605.02
Smart fixture deembedding (SFD)	R&S®ZNB-K230		1328.8611.02
<b>Real-time measurement uncertainty analysis</b>			
Real-time measurement uncertainty analysis (METAS tool to be installed)	R&S®ZNB-K50		3644.5977.02
Real-time measurement uncertainty analysis (METAS tool preinstalled)	R&S®ZNB-K50P		1338.1810.02
<b>Further software options</b>			
10 MHz IF bandwidth	R&S®ZNB-K17		1316.1881.02
1 mHz frequency resolution	R&S®ZNB-K19		1317.8573.02
Delta-L 4.0 PCB characterization	R&S®ZNB-K231		1328.8628.02
Health and utilization monitoring service (HUMS)	R&S®ZNB-K980		1350.5305.02
<b>Switch matrices</b>			
<b>R&amp;S®ZN-Z84 switch matrix up to 8.5 GHz, with up to 24 ports</b>			
Switch matrix, base unit, 2 VNA ports to 6 matrix ports, SMA (f) <sup>6)</sup>	R&S®ZN-Z84	10 MHz to 8.5 GHz	1319.4500.02
Additional test ports 7 to 12, 4 VNA ports to 12 matrix ports <sup>7)</sup>	R&S®ZN-Z84-B24	10 MHz to 8.5 GHz	1319.4969.24
Additional test ports 7 to 12, 2 VNA ports to 12 matrix ports <sup>7)</sup>	R&S®ZN-Z84-B22	10 MHz to 8.5 GHz	1319.4969.22
Additional test ports 13 to 18, 4 VNA ports to 18 matrix ports <sup>8)</sup>	R&S®ZN-Z84-B34	10 MHz to 8.5 GHz	1319.4969.34
Additional test ports 13 to 18, 2 VNA ports to 18 matrix ports <sup>8)</sup>	R&S®ZN-Z84-B32	10 MHz to 8.5 GHz	1319.4969.32
Additional test ports 19 to 24, 4 VNA ports to 24 matrix ports <sup>9)</sup>	R&S®ZN-Z84-B44	10 MHz to 8.5 GHz	1319.4969.44
Additional test ports 19 to 24, 2 VNA ports to 24 matrix ports <sup>9)</sup>	R&S®ZN-Z84-B42	10 MHz to 8.5 GHz	1319.4969.42
<b>R&amp;S®ZN-Z85 switch matrix up to 20 GHz, with up to 12 ports</b>			
Switch matrix, base unit, 2 VNA ports to 6 matrix ports, SMA (f) <sup>10)</sup>	R&S®ZN-Z85	10 MHz to 20 GHz	1326.4777.03
Additional test ports 7 to 12, 4 VNA ports to 12 matrix ports <sup>11)</sup>	R&S®ZN-Z85-B24	10 MHz to 20 GHz	1326.4831.26

<sup>2)</sup> Required for direct control of R&S®ZN-Z84/R&S®ZN-Z85 switch matrix and R&S®ZN-Z15 external RFFE GPIO interface.

<sup>3)</sup> Requires R&S®ZNB-K2.

<sup>4)</sup> Requires R&S®ZVAB-B44 for control of external sources via the IEC/IEEE bus.

<sup>5)</sup> Requires R&S®ZNB-K4.

<sup>6)</sup> Includes cables for connecting an R&S®ZN-Z84 switch matrix to an R&S®ZNB4/R&S®ZNB8 analyzer.

<sup>7)</sup> Requires R&S®ZN-Z84.

<sup>8)</sup> Requires R&S®ZN-Z84-B2x.

<sup>9)</sup> Requires R&S®ZN-Z84-B3x.

<sup>10)</sup> Includes cables for connecting an R&S®ZN-Z85 switch matrix to an R&S®ZNB20 analyzer.

<sup>11)</sup> Requires R&S®ZN-Z85.

Designation	Type	Frequency range	Order No.
<b>Calibration</b>			
<b>Calibration kits for manual calibration – economy</b>			
Calibration kit, N	R&S®ZCAN	0 Hz to 3 GHz	0800.8515.52
Calibration kit, N (m)	R&S®ZN-Z170	0 Hz to 18 GHz	1328.8163.02
Calibration kit, N (f)	R&S®ZN-Z170	0 Hz to 18 GHz	1328.8163.03
Calibration kit, 3.5 mm (m)	R&S®ZN-Z135	0 Hz to 26.5 GHz	1328.8157.02
Calibration kit, 3.5 mm (f)	R&S®ZN-Z135	0 Hz to 26.5 GHz	1328.8157.03
Calibration kit, 2.92 mm (m)	R&S®ZN-Z129	0 Hz to 40 GHz	1328.8140.02
Calibration kit, 2.92 mm (f)	R&S®ZN-Z129	0 Hz to 40 GHz	1328.8140.03
<b>Calibration kits for manual calibration – high-end</b>			
Calibration kit, N (m and f)	R&S®ZV-Z270	0 Hz to 18 GHz	5011.6536.02
Calibration kit, 3.5 mm (m and f)	R&S®ZN-Z235	0 Hz to 26.5 GHz	1336.8500.02
Calibration kit, 2.92 mm (m and f)	R&S®ZN-Z229	0 Hz to 43.5 GHz	1336.7004.02
Calibration kit, 2.4 mm (m and f)	R&S®ZN-Z224	0 Hz to 50 GHz	1339.5002.02
<b>Calibration units for automatic calibration – economy</b>			
Calibration unit, 2 ports, SMA (f)	R&S®ZN-Z151	100 kHz to 8.5 GHz	1317.9134.32
Calibration unit, 2 ports, N (f)	R&S®ZN-Z151	100 kHz to 8.5 GHz	1317.9134.72
Calibration unit, 4 ports, SMA (f)	R&S®ZN-Z153	100 kHz to 8.5 GHz	1319.6178.34
Calibration unit, 6 ports, SMA (f)	R&S®ZN-Z152	100 kHz to 8.5 GHz	1319.6003.36
Calibration unit, 6 ports, SMA (f), rackmount form factor	R&S®ZN-Z154	100 kHz to 8.5 GHz	1319.5120.02
Additional ports 7 to 12, SMA (f) <sup>12)</sup>	R&S®ZNZ154-B22	100 kHz to 8.5 GHz	1319.5136.22
Additional ports 13 to 18, SMA (f) <sup>13)</sup>	R&S®ZNZ154-B32	100 kHz to 8.5 GHz	1319.5136.32
Additional ports 19 to 24, SMA (f) <sup>14)</sup>	R&S®ZNZ154-B42	100 kHz to 8.5 GHz	1319.5136.42
<b>Calibration units for automatic calibration – high-end</b>			
Calibration unit, 2 ports, N (f) <sup>15)</sup>	R&S®ZN-Z51	100 kHz to 8.5 GHz	1319.5507.72
Calibration unit, 2 ports, 3.5 mm (f)	R&S®ZN-Z51	100 kHz to 8.5 GHz	1319.5507.32
Calibration unit, 4 ports, N (f) <sup>15)</sup>	R&S®ZN-Z51	100 kHz to 8.5 GHz	1319.5507.74
Calibration unit, 4 ports, 3.5 mm (f)	R&S®ZN-Z51	100 kHz to 8.5 GHz	1319.5507.34
Calibration unit, 2 ports, 3.5 mm (f)	R&S®ZN-Z50	9 kHz to 9 GHz	1335.6904.30
Calibration unit, 2 ports, 3.5 mm (f)	R&S®ZN-Z50	9 kHz to 26.5 GHz	1335.6904.32
Calibration unit, 4 ports, 3.5 mm (f)	R&S®ZN-Z52	100 kHz to 26.5 GHz	1335.6991.30
Calibration unit, 2 ports, 3.5 mm (f)	R&S®ZN-Z53	100 kHz to 26.5 GHz	1335.7046.32
Calibration unit, 2 ports, N (f)	R&S®ZN-Z53	100 kHz to 18 GHz	1335.7046.72
Calibration unit, 2 ports, 2.92 mm (f)	R&S®ZN-Z54	9 kHz to 40 GHz	1335.7117.92
Calibration unit, 2 ports, 2.4 mm (f)	R&S®ZN-Z55	9 kHz to 50 GHz	1335.7181.42
Calibration unit, 8 ports, N (f), rackmount form factor	R&S®ZV-Z58	300 kHz to 8 GHz	1164.0638.78
Calibration unit, 6 ports, 3.5 mm (f), rackmount form factor	R&S®ZV-Z59	10 MHz to 20 GHz	1164.0450.36
<b>Inline calibration units for automatic calibration – high-end</b>			
Inline calibration unit controller	R&S®ZN-Z30		1328.7609.02
Inline calibration unit, 10 MHz to 8.5 GHz	R&S®ZN-Z32		1328.7638.02
Inline calibration unit, 10 MHz to 40 GHz	R&S®ZN-Z33		1328.7644.02
Inline calibration unit, 10 MHz to 40 GHz, for use in thermal vacuum chambers (TVAC)	R&S®ZN-Z33		1328.7644.03
<b>Verification kits</b>			
Verification kit, N	R&S®ZV-Z470	45 MHz to 18 GHz	1319.1053.02
Verification kit, 3.5 mm	R&S®ZV-Z435	45 MHz to 26.5 GHz	1319.1060.02
Verification kit, 2.92 mm	R&S®ZV-Z429	45 MHz to 40 GHz	1319.1076.02
Verification kit, 2.4 mm	R&S®ZV-Z424	45 MHz to 50 GHz	1319.1082.02

<sup>12)</sup> Requires R&S®ZN-Z154.

<sup>13)</sup> Requires R&S®ZNZ154-B22.

<sup>14)</sup> Requires R&S®ZNZ154-B32.

<sup>15)</sup> Can be configured ex factory with N (m/f), 3.5 mm (m/f), 7/16 (m/f) (see R&S®ZN-Zxxx data sheet, PD 5214.8995.22).

Designation	Type	Frequency range	Order No.
<b>Test cables</b>			
<b>Test cables – high precision, ruggedized</b>			
N (m) to N (m), length: 0.6 m/1 m	R&S®ZV-Z91	0 Hz to 18 GHz	1301.7572.25/.38
N (m) to 3.5 mm (m), length: 0.6 m/1 m	R&S®ZV-Z92	0 Hz to 18 GHz	1301.7589.25/.38
3.5 mm (f) to 3.5 mm (m), length: 0.6 m/1 m	R&S®ZV-Z93	0 Hz to 26.5 GHz	1301.7595.25/.38
2.92 mm (f) to 2.92 mm (m), length: 0.6 m/1 m	R&S®ZV-Z95	0 Hz to 40 GHz	1301.7608.25/.38
2.4 mm (f) to 2.4 mm (m), length: 0.6 m	R&S®ZV-Z97	0 Hz to 50 GHz	1301.7637.25
<b>Test cables – high precision</b>			
N (m) to N (m), length: 0.6 m/0.9 m	R&S®ZV-Z191	0 Hz to 18 GHz	1306.4507.24/.36
N (m) to 3.5 mm (m), length: 0.6 m/0.9 m	R&S®ZV-Z192	0 Hz to 18 GHz	1306.4513.24/.36
3.5 mm (f) to 3.5 mm (m), length: 0.6 m/0.9 m/1.5 m	R&S®ZV-Z193	0 Hz to 26.5 GHz	1306.4520.24/.36/.60
2.92 mm (f) to 2.92 mm (m), length: 0.6 m/0.9 m	R&S®ZV-Z195	0 Hz to 40 GHz	1306.4536.24/.36
<b>Hardware add-ons</b>			
19" rack adapter, 2 RU (e.g. for R&S®ZN-Z84)	R&S®ZZA-KN2		1175.3010.00
19" rack adapter, 5 RU (e.g. for R&S®ZNB)	R&S®ZZA-KN5		1175.3040.00
RF cable set, N (m)/3.5 mm (m), for connecting two 2 × n-port R&S®ZN-Z84 switch matrices to a 4-port R&S®ZNB4 or R&S®ZNB8	R&S®ZN-Z28	10 MHz to 8.5 GHz	1326.6605.02
Additional removable SSD, 512 Gbyte, Windows 10	R&S®ZNB-B19		1334.3860.03
USB-to-IEC/IEEE adapter	R&S®ZVAB-B44		1302.5544.02
<b>VNA software</b>			
<b>VNA test automation software</b>			
R&S®ZNRUN VNA test automation software (core software)	R&S®ZNRUN-K1		1326.7124.02
Multi-client capability (option)	R&S®ZNRUN-K2		1326.7130.02
DUT/VNA multiplicity (option)	R&S®ZNRUN-K5		1334.4237.02
Measurement tuning capability (option)	R&S®ZNRUN-K6		1334.4250.02
Software maintenance for R&S®ZNRUN-K1 (option)	R&S®ZNRUNSWMK1		1334.4214.81
Software maintenance for R&S®ZNRUN-K5 (option)	R&S®ZNRUNSWMK5		1334.4243.81
Software maintenance for R&S®ZNRUN-K6 (option)	R&S®ZNRUNSWMK6		1334.4220.81
<b>VNA simulation software</b>			
Simulation of R&S®ZNB, R&S®ZNBt, R&S®ZNC, R&S®ZND <sup>16)</sup>	R&S®ZNXSIM-K1		1334.4066.02
Time domain analysis (TDR) for VNA simulation <sup>17)</sup>	R&S®ZNXSIM-K22		1338.1632.02
<b>License dongle</b>			
License dongle	R&S®ZNPC		1325.6601.02

<sup>16)</sup> Requires R&S®ZNPC.

<sup>17)</sup> Requires R&S®ZNXSIM-K1.

Warranty		
Base unit		3 years
All other items <sup>1)</sup>		1 year
Service options		
Extended warranty, one year	R&S®WE1	
Extended warranty, two years	R&S®WE2	
Extended warranty with calibration coverage, one year	R&S®CW1	Please contact your local Rohde&Schwarz sales office.
Extended warranty with calibration coverage, two years	R&S®CW2	
Extended warranty with accredited calibration coverage, one year	R&S®AW1	
Extended warranty with accredited calibration coverage, two years	R&S®AW2	

<sup>1)</sup> For options that are installed, the remaining base unit warranty applies if longer than 1 year.  
Exception: All batteries have a 1 year warranty.

For information about the R&S®ZNB40 40 GHz model, see R&S®ZNB40 product brochure (PD 5214.5384.12) and data sheet (PD 5214.5384.22).

Your local Rohde&Schwarz expert will help you determine the optimum solution for your requirements. To find your nearest Rohde&Schwarz representative, visit [www.sales.rohde-schwarz.com](http://www.sales.rohde-schwarz.com)

The Bluetooth® word mark and logos are registered trademarks owned by Bluetooth SIG, Inc. and any use of such marks by Rohde&Schwarz is under license.  
The terms HDMI and HDMI High-Definition Multimedia Interface, and the HDMI Logo are trademarks or registered trademarks of HDMI Licensing, LLC in the United States and other countries.  
MIPI® marks and logos are service marks owned by MIPI Alliance, Inc. and any use of such marks by Rohde&Schwarz is under license.

# FROM PRESALES TO SERVICE. AT YOUR DOORSTEP.

The Rohde&Schwarz network in over 70 countries ensures optimum on-site support by highly qualified experts.

User risks are reduced to a minimum at all project stages:

- ▶ Solution finding/purchase
- ▶ Technical startup/application development/integration
- ▶ Training
- ▶ Operation/calibration/repair



## Service that adds value

- ▶ Worldwide
- ▶ Local and personalized
- ▶ Customized and flexible
- ▶ Uncompromising quality
- ▶ Long-term dependability

## Rohde & Schwarz

The Rohde&Schwarz technology group is among the trail-blazers when it comes to paving the way for a safer and connected world with its leading solutions in test & measurement, technology systems and networks&cybersecurity. Founded more than 85 years ago, the group is a reliable partner for industry and government customers around the globe. The independent company is headquartered in Munich, Germany and has an extensive sales and service network with locations in more than 70 countries.

[www.rohde-schwarz.com](http://www.rohde-schwarz.com)

## Sustainable product design

- ▶ Environmental compatibility and eco-footprint
- ▶ Energy efficiency and low emissions
- ▶ Longevity and optimized total cost of ownership

Certified Quality Management

ISO 9001

Certified Environmental Management

ISO 14001

## Rohde & Schwarz training

[www.training.rohde-schwarz.com](http://www.training.rohde-schwarz.com)

## Rohde & Schwarz customer support

[www.rohde-schwarz.com/support](http://www.rohde-schwarz.com/support)

