

Article datasheet

## SEMS Screw DIN6900-3 Z4-1 M3x8 Galv. ST 4.8 Washer + Spring Lock Washer

Article-No.: 081.58.336



Image may be similar

Actuator Size:	Pozidriv PZ1
Combination:	Washer DIN6902-1 and Spring Lock Washer DIN6905
DIN/ISO:	DIN7985 / ISO7045
Drive Type:	Cross Recess / Pozidriv-Z
Finish:	Galvanized, Blue, 5 µm, A2K
Head Diameter [mm]:	6
Head Height [mm]:	2.4
Head Shape:	Pan Head
Length [mm]:	8
Material:	Steel 4.8
Thread Size:	M3
Weight:	0.9g
Conformities:	

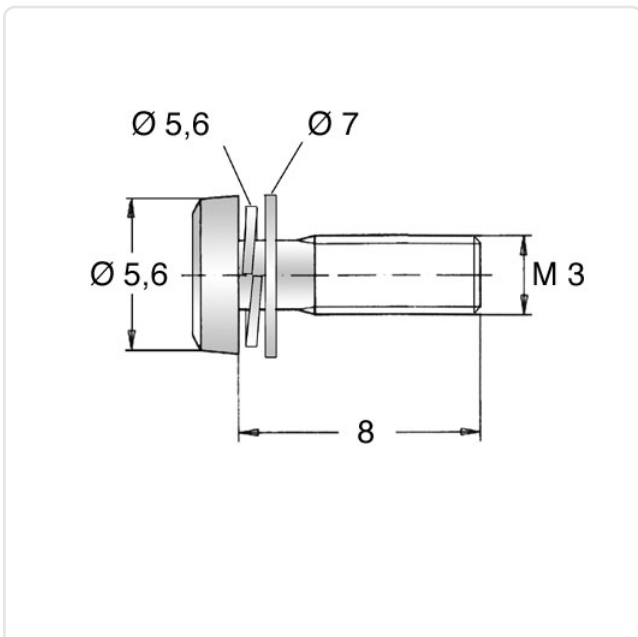

You can find all information on the web on our article detail page

Would you like individual advice?

We look forward to your email to [products@ettinger.de](mailto:products@ettinger.de).

Subject to change and errors.