

THIS DOCUMENT IS THE PROPERTY OF
KEYSTONE ELECTRONICS CORP. AND
SHALL NOT BE REPRODUCED, DISTRIBUTED
OR USED AS A BASIS FOR MANUFACTURE
WITHOUT PRIOR WRITTEN PERMISSION
FROM KEYSTONE ELECTRONICS CORP.

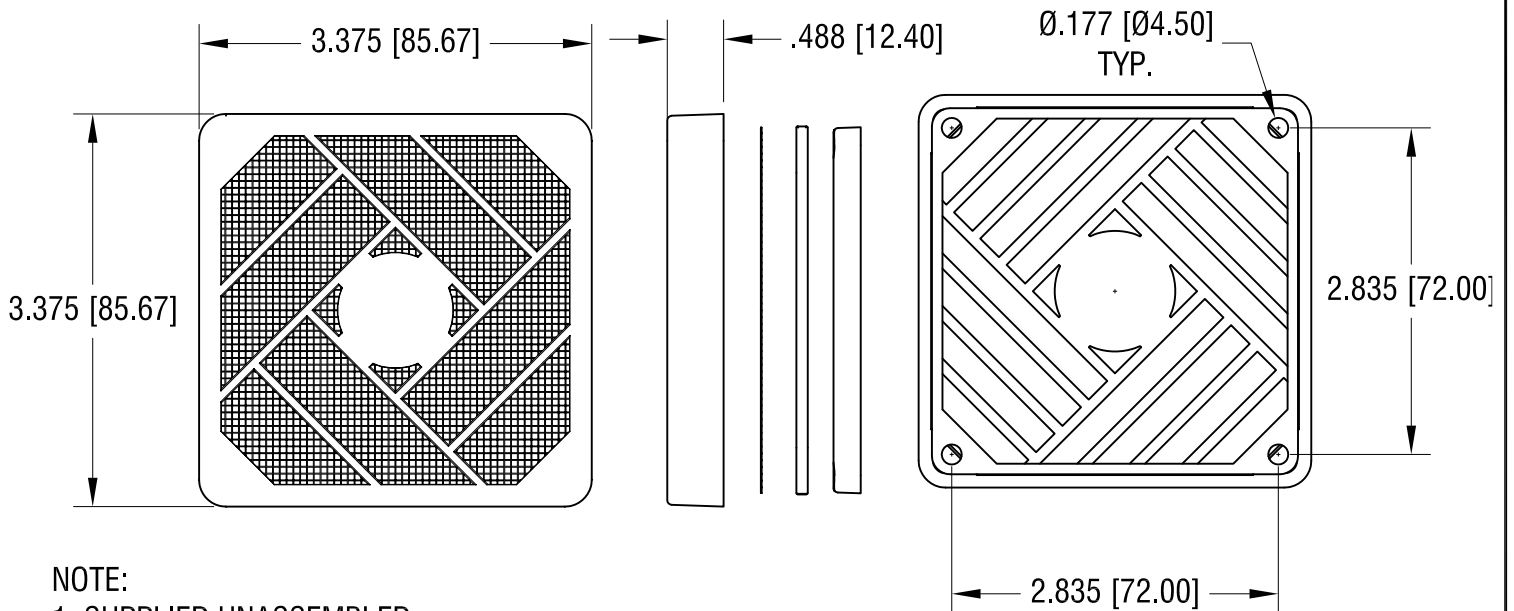
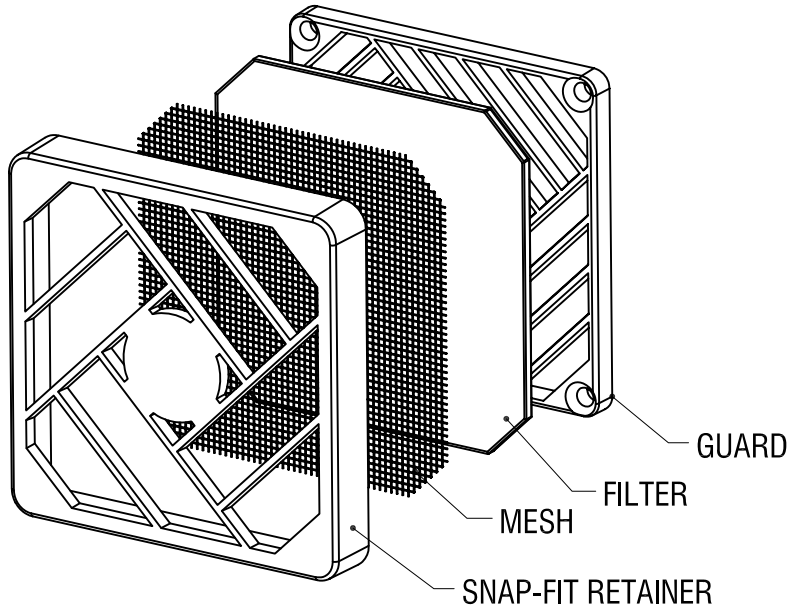

NOTE:

1. SUPPLIED UNASSEMBLED:

FAN GUARD (1) ONE PIECE: MAT'L- 25% GLASS FILLED NYLON 6/6

RETAINER (1) ONE PIECE: MAT'L- 25% GLASS FILLED NYLON 6/6

FILTER INCLUDES: a) MESH (1) ONE PICE: MAT'L- ALUMINUM

b) FILTER (1) ONE PICE: MAT'L- POLYESTER

KEYSTONE ELECTRONICS CORP.

www.keyelco.com • ASTORIA, N.Y. 11105-2017 • Tel (718) 956-8900

PART NAME

FAN FILTER ASSEMBLY FOR Ø80mm FAN

MATERIAL

AS NOTED

FINISH

AS NOTED

DRN BY

NT

DATE

2.01.13

APP'D

LN

SCALE

.7X

TOLERANCES

INCH [MM]

DECIMAL ±.010 [±0.25]

ANGULAR ± 1°

UNLESS OTHERWISE SPECIFIED

CODE

C

DWG NO.

8487

DATE

DESCRIPTION

REV.