

2J7010B

TETRA Screw Mount

Key Features

TETRA
- 380-470 MHz
Screw Mount
High Gain
Loaded Dipole
Ground Plane Dependent
Anti-Rotation Mounting
Dimensions $\varnothing 96 \times 130$ mm
DC Grounded Antenna
Certificates IP67, IP69, IK09



1. Antenna and electrical specifications

Parameters	TETRA Antenna
Standards	TETRA
Band (MHz)	400
Frequency (MHz)	380-470
Return Loss (dB)	~-14.7
VSWR	~1.5:1
Efficiency (%)	~73
Peak Gain (dBi)	~2.5
Average Gain (dB)	~-1.4
Impedance (Ohm)	50
Polarisation	Linear
Radiation Pattern	Omni-Directional
Max. Input Power (W)	50
Connector Type	N-Female Standard

Antenna Measurement Conditions:

Free Space

Mounted on Ground Plane of 60 x 60 cm

Measured in Certified CTIA 3D Anechoic Chamber

2. Mechanical and environmental specifications

Specifications	2J7010B
Mounting Type	Screw Mount
Dimensions (mm)	Ø 96 × 130
Radome	ASA UV Stable
Radome color	Black, White
Antenna Base	Alluminium alloy
Operating Temperature (C)	-40 to +85
Storage Temperature (C)	-40 to +85
Substance Compliance	RoHS
Certificates	IP67, IP69, IK09

3. Antenna parameters

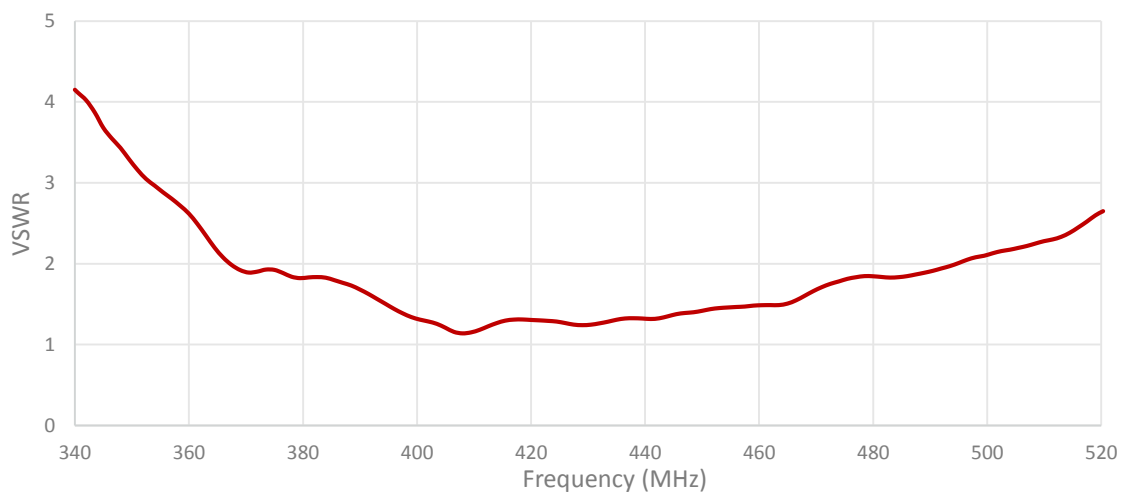
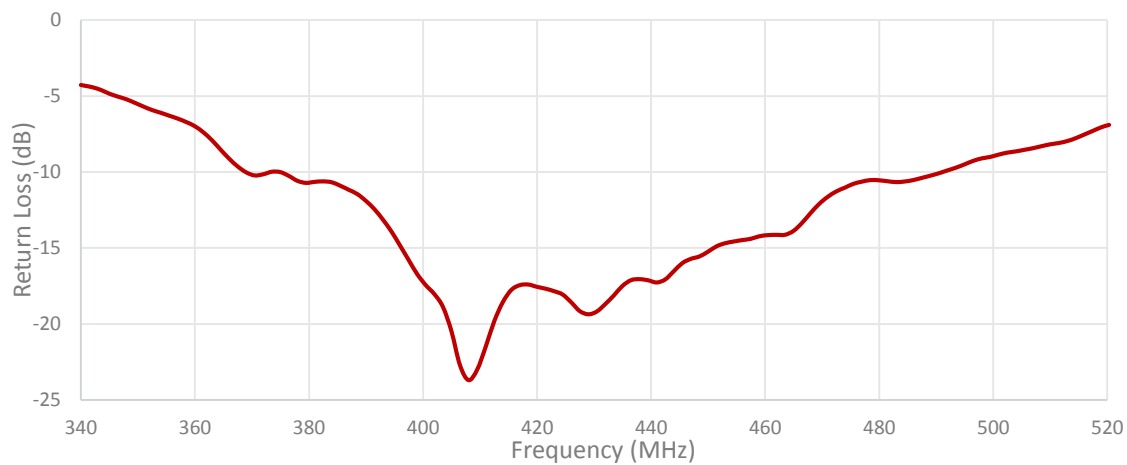

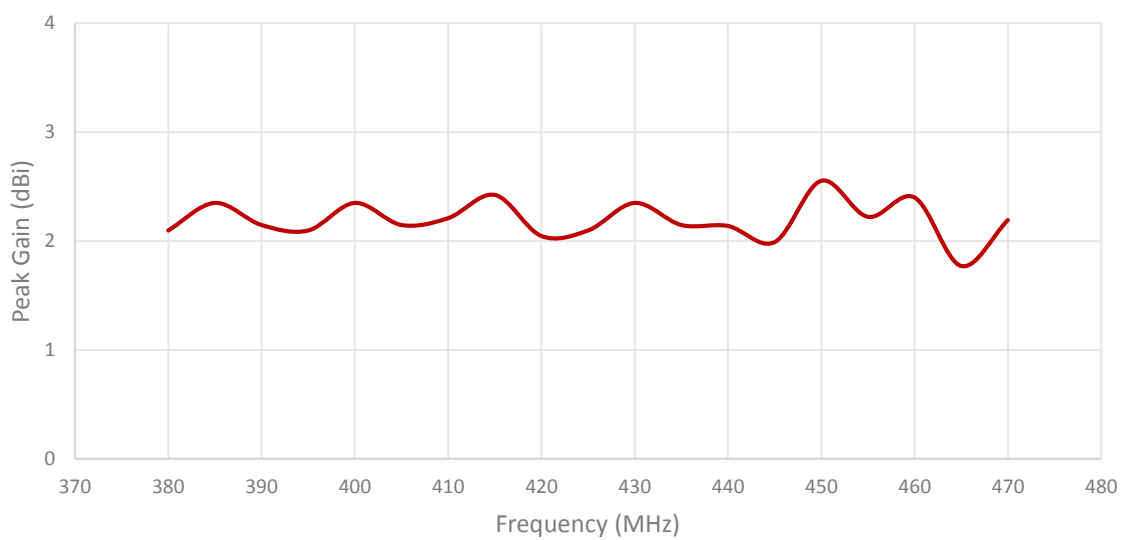
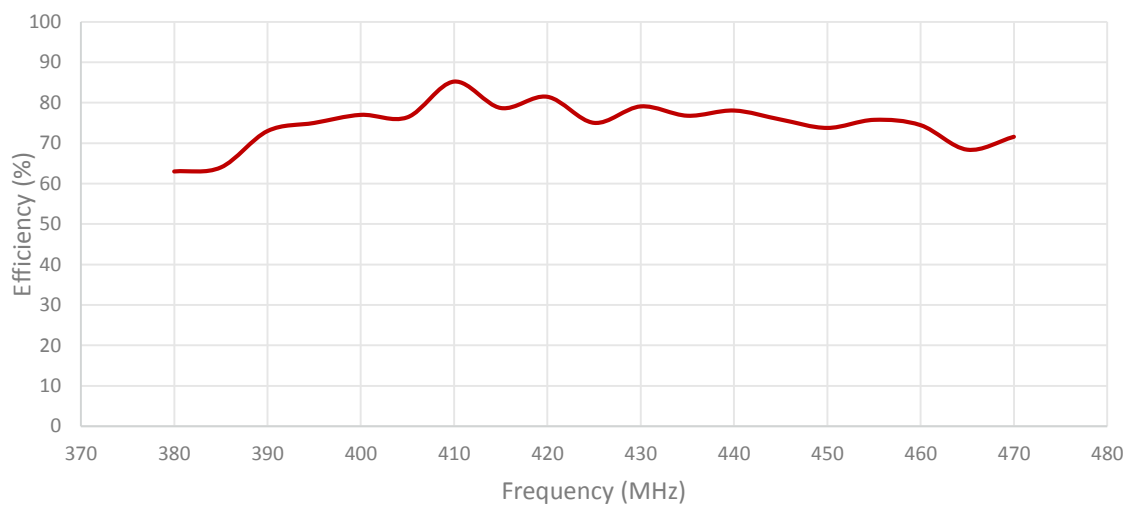

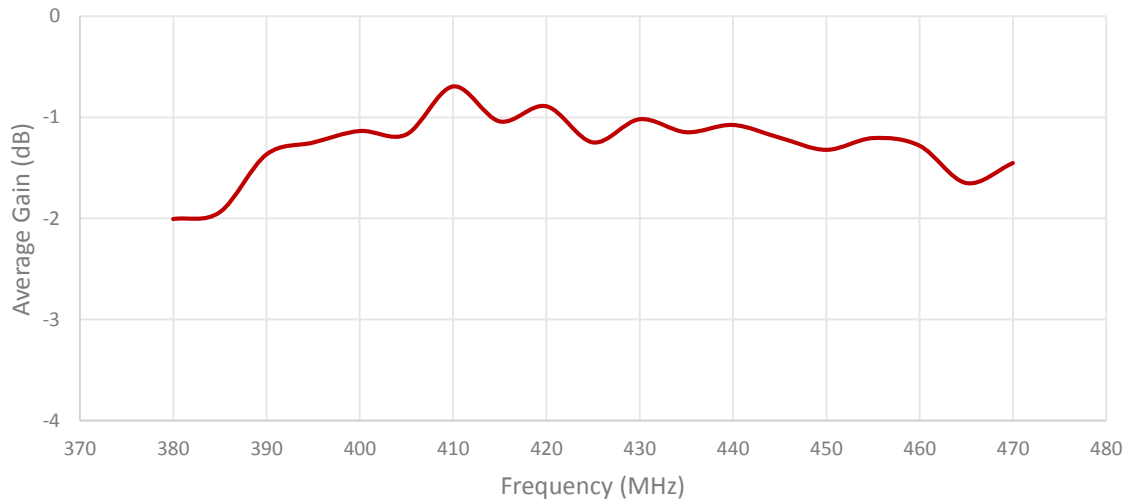

Radiation pattern reference

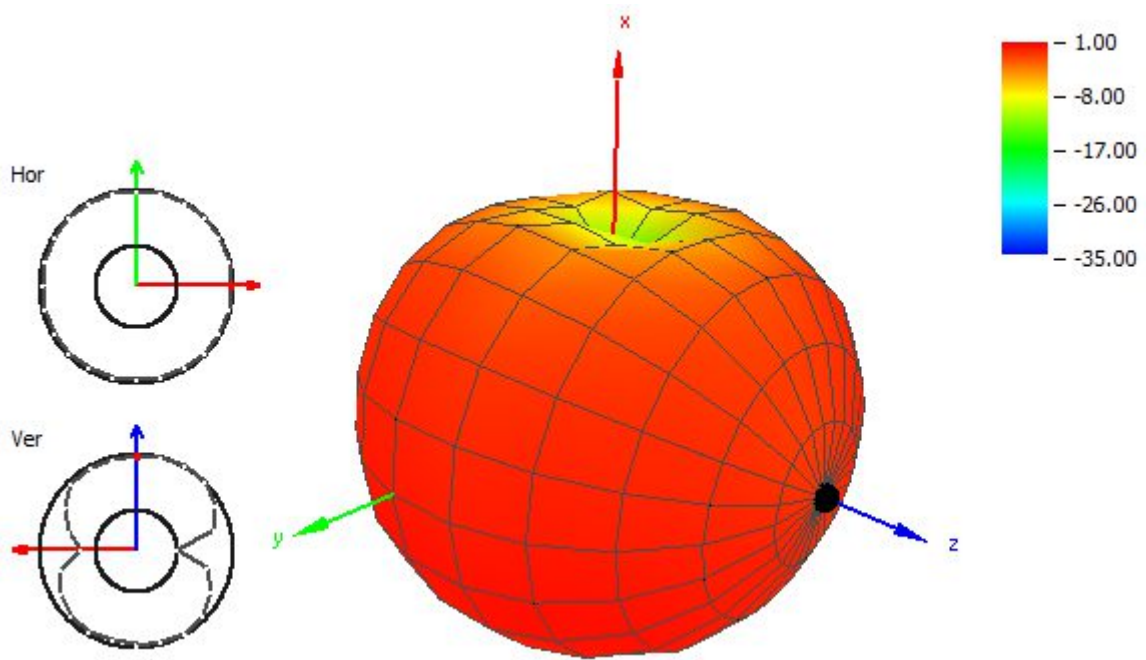

425 MHz Radiation pattern

4. Antenna drawings

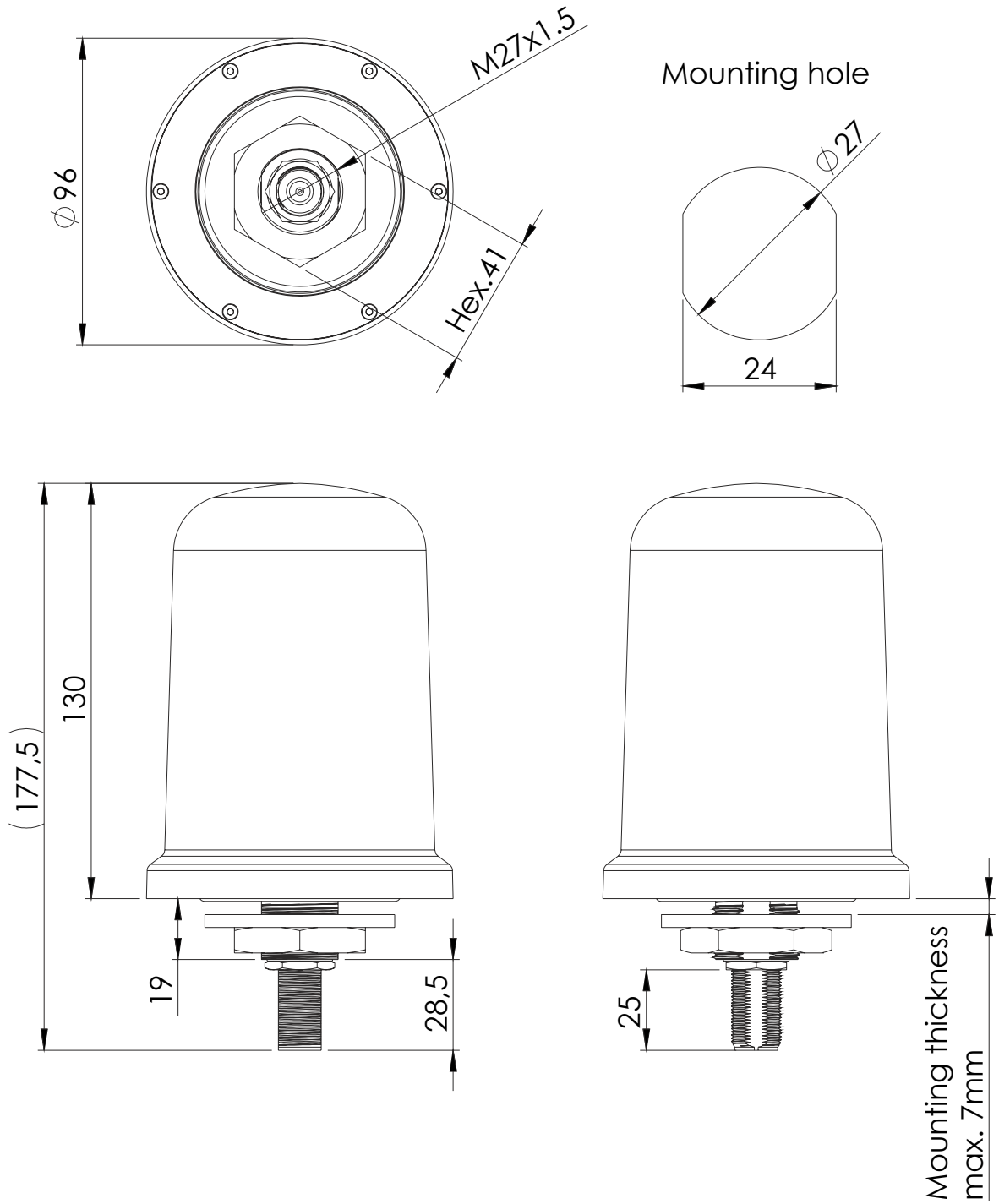

5. Antenna Images

