

Display Elektronik GmbH

DATA SHEET

TFT MODULE

**DEM 2403200 VMH-PW-N
(C1-TOUCH)**

2,0" TFT + PCT

Product Specification

Ver.: 2

10.06.2023

Revision History

Revision	Date	Detail	Remarks
0	10.06.2017	Initial Release	-
1	21.08.2020	Modify CTP IC Modify Inspection Specification Modify Reliability Specification Modify Outline Drawing	P6 P21 P25 P28
2	10.06.2023	Modify Module Outline Modify Optical Glue Modify Packaging Modify Outline Drawing	P4 P6 P28 P29

Table of Contents

No.	Item	Page
1.	General Description.....	4
2.	Module Parameter.....	4
3.	Absolute Maximum Ratings.....	4
4.	DC Characteristics	5
5.	Backlight Characteristic.....	5
5.1.	Backlight Characteristics	5
5.2.	Backlighting Circuit.....	5
6.	Touch Screen Panel Specifications	6
7.	Optical Characteristics	8
7.1.	Optical Characteristics	8
7.2.	Definition of Response Time	8
7.3.	Definition of Contrast Ratio	9
7.4.	Definition of Viewing Angles	9
7.5.	Definition of Color Appearance.....	10
7.6.	Definition of Surface Luminance, Uniformity and Transmittance	10
8.	Block Diagram and Power Supply.....	11
9.	Interface Pins Definition	12
10.	Timing Characteristics.....	14
10.1.	Display Serial Interface Timing Characteristics (3-line SPI system)	14
10.2.	Parallel 18/16/6-bit RGB Interface Timing Characteristics	15
10.3.	Reset timing.....	16
11.	Quality Assurance	17
11.1.	Purpose	17
11.2.	Standard for Quality Test	17
11.3.	Nonconforming Analysis & Disposition.....	17
11.4.	Agreement Items	17
11.5.	Standard of the Product Visual Inspection	17
11.6.	Inspection Specification.....	18
11.7.	Classification of Defects	25
11.8.	Identification/marketing criteria.....	25
11.9.	Packaging.....	25
12.	Reliability Specification.....	26
13.	Precautions and Warranty.....	27
13.1.	Safety	27
13.2.	Handling	27
13.3.	Storage	27
13.4.	Metal Pin (Apply to Products with Metal Pins).....	27
13.5.	Operation.....	28
13.6.	Static Electricity	28
13.7.	Limited Warranty	28
14.	Outline Drawing.....	29

1. General Description

The specification is a transmissive type color active matrix liquid crystal display (LCD) which uses amorphous thin film transistor (TFT) as switching devices. This product is composed of a TFT-LCD panel, driver ICs, touch panel and a backlight unit.

2. Module Parameter

Features	Details	Unit
Display Size (Diagonal)	2.0"	-
LCD Type	MVA TFT	-
Display Mode	Transmissive / Normally White	-
Resolution	240 x RGB x 320	Pixels
View Direction	FULL VIEW	Best Image
Module Outline	43.68 x 57.30 x 4.25 (Note1)	mm
Active Area	30.60 x 40.80	mm
Pixel Size	0.1275 x 0.1275	mm
Pixel Arrangement	R.G.B. Vertical Stripe	-
Polarizer Surface Treatment	Anti-Glare	-
Display Colors	262k	-
Interface	18-Bit-RGB-Interface + 3-Wire-SPI	-
Driver IC	ILI9341V (Ilitek)	-
With or Without Touch Panel	With Projective Capacitive Touch	-
Operating Temperature	-20°C to +70°C	°C
Storage Temperature	-30°C to +80°C	°C
Weight	~ 17	g

Note 1: Exclusive hooks, posts, FFC/FPC tail etc.

3. Absolute Maximum Ratings

V_{SS}=0V, Ta=25°C

Item	Symbol	Min.	Max.	Unit
Supply Voltage	VDD	-0.3	4.6	V
	IOVCC	-0.3	4.6	V
Storage Temperature	T _{STG}	-30	80	°C
Operating Temperature	T _{OP}	-20	70	°C

Note 1: If Ta below 50°C, the maximal humidity is 90%RH, if Ta over 50°C, absolute humidity should be less than 60%RH.

Note 2: The response time will be extremely slow when the operating temperature is around -10°C, and the back ground will become darker at high temperature operating.

4. DC Characteristics

Item	Symbol	Min.	Typ.	Max.	Unit	
Supply Voltage	VDD	2.5	3.3	3.3	V	
	IOVCC	1.65	1.8	3.3	V	
Logic Low input voltage	V _{IL}	GND	-	0.3*IOVCC	V	
Logic High input voltage	V _{IH}	0.7*IOVCC	-	IOVCC	V	
Logic Low output voltage	V _{OL}	GND	-	0.2*IOVCC	V	
Logic High output voltage	V _{OH}	0.8*IOVCC	-	IOVCC	V	
Current Consumption All Black	Logic Analog	I _{CC+ I_{IN}}	-	10	-	mA

5. Backlight Characteristic

5.1. Backlight Characteristics

Item	Symbol	Condition	Min.	Typ.	Max.	Unit
Forward Voltage	V _F	T _a =25 °C, I _F =15mA/LED	2.8	3.2	3.4	V
Forward Current	I _F	T _a =25 °C, V _F =3.2V/LED	-	45	-	mA
Power Dissipation	P _D		-	144	-	mW
Uniformity	Avg		-	80	-	%
LED Lifetime (25°C)	-		-	30000	-	Hrs
Drive Method	Constant Current					
LED Configuration	3 White LEDs in Parallel					

Note: LED life time defined as follows: The final brightness is at 50% of original brightness.
The environmental conducted under ambient air flow, at T_a=25°C±2°C, 60%RH±5%, I_F=15mA.

5.2. Backlighting Circuit

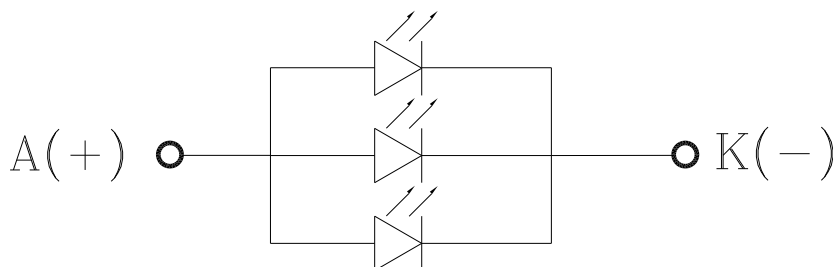

6. Touch Screen Panel Specifications

Item	CTP Description	
1	IC	FT5446 
2	Interface	IIC
3	Operation voltage	2.8~3.3V
4	Interface signal voltage	2.8~3.3V
5	Surface hardness	≥6H
6	Operation temperature	-20°C~+70°C
7	Storage temperature	-30°C~+80°C
8	Strengthened Type	Chemical
9	Transmittance	≥85%
10	Origin of coordinates	T/L
11	Resolution Ratio	240*320

Item	Main layer define	Thickness/materials
1	Lens	0.7mm/Glass
2	Optical Glue	0.2mm 
3	sensor	0.55mm

7. Optical Characteristics

7.1. Optical Characteristics

Ta=25°C, VDD=2.8V, TN LC+ Polarizer

	Item	Symbol	Condition	Specification			Unit	
				Min.	Typ.	Max.		
Backlight On (Transmissive Mode)	Luminance on TFT ($I_f = 15\text{mA/LED}$)	Lv	Normally viewing angle $\theta_x = \phi_y = 0^\circ$	190	240	-	cd/m ²	
	Contrast Ratio(See 6.3)	CR		150	300	-		
	Response Time (See 6.2)	TR+TF		-	25	50	ms	
	Chromaticity Transmissive (See 6.5)	Red	X _R	Center CR≥10	0.574	0.624	0.674	
			Y _R		0.307	0.357	0.407	
		Green	X _G		0.275	0.325	0.375	
			Y _G		0.571	0.621	0.671	
		Blue	X _B		0.096	0.146	0.196	
			Y _B		0.063	0.113	0.163	
	White	X _W	0.233	0.283	0.333			
Y _W		0.286	0.336	0.386				
Viewing Angle (See 6.4)	Horizontal	θ_{x+}	Center CR≥10	-	70	-	Deg.	
		θ_{x-}		-	70	-		
	Vertical	ϕ_{y+}		-	70	-		
		ϕ_{y-}		-	70	-		
NTSC Ratio(Gamut)				-	58	-	%	

7.2. Definition of Response Time

7.2.1. Normally Black Type (Negative)

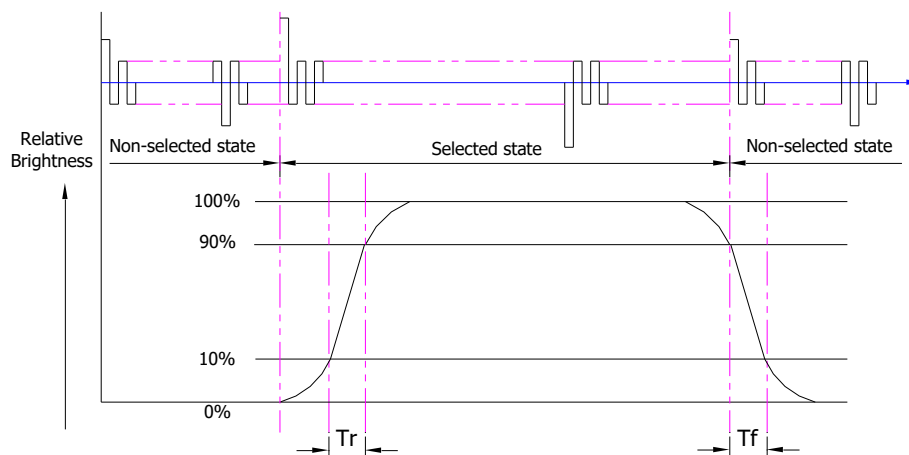

T_r is the time it takes to change from non-selected stage with relative luminance 10% to selected state with relative luminance 90%;

T_f is the time it takes to change from selected state with relative luminance 90% to non-selected state with relative luminance 10%.

Note: Measuring machine: LCD-5100

7.2.2. Normally White Type (Positive)

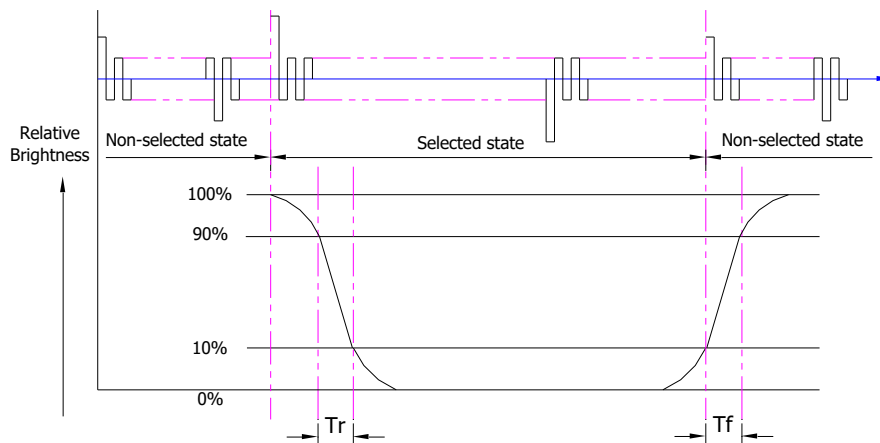

Tr is the time it takes to change from non-selected stage with relative luminance 90% to selected state with relative luminance 10%;

Tf is the time it takes to change from selected state with relative luminance 10% to non-selected state with relative luminance 90%;

Note: Measuring machine: LCD-5100 or EQUI

7.3. Definition of Contrast Ratio

Contrast is measured perpendicular to display surface in reflective and transmissive mode.

The measurement condition is:

Measuring Equipment	Eldim or Equivalent
Measuring Point Diameter	3mm//1mm
Measuring Point Location	Active Area centre point
Test pattern	A: All Pixels white
	B: All Pixel black
Contrast setting	Maximum

Definitions: CR (Contrast) = Luminance of White Pixel / Luminance of Black Pixel

7.4. Definition of Viewing Angles

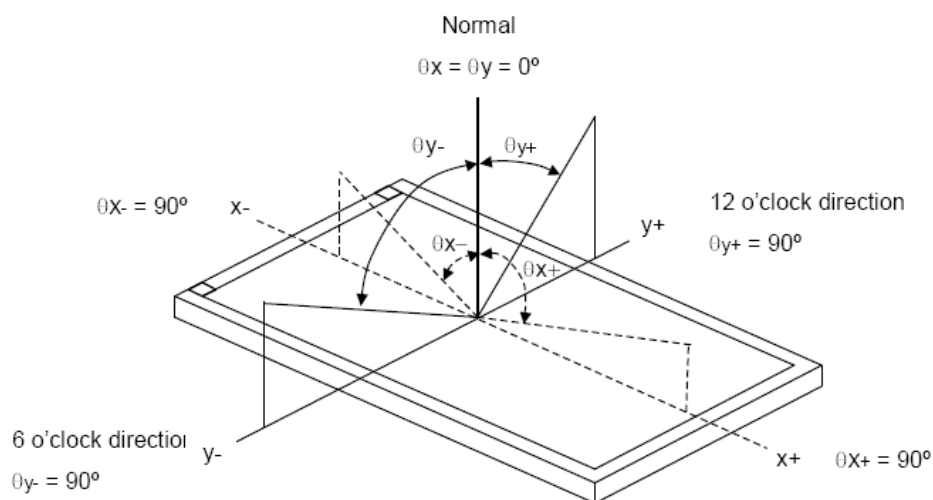

Measuring machine: LCD-5100 or EQUI

7.5. Definition of Color Appearance

R,G,B and W are defined by (x, y) on the IE chromaticity diagram

NTSC=area of RGB triangle/area of NTSC triangleX100%

Measuring picture: Red, Green, Blue and White (Measuring machine: BM-7)

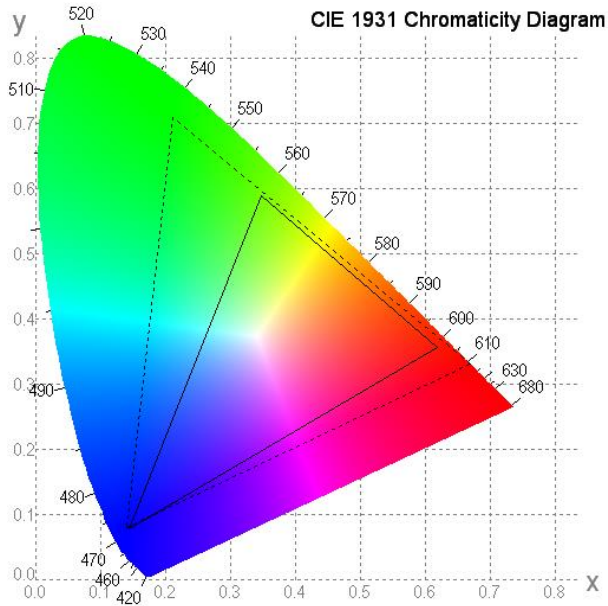

7.6. Definition of Surface Luminance, Uniformity and Transmittance

Using the transmissive mode measurement approach, measure the white screen luminance of the display panel and backlight.

7.6.1. Surface Luminance: $L_v = \text{average} (L_{P1}:L_{P9})$

7.6.2. Uniformity = $\text{Minimal} (L_{P1}:L_{P9}) / \text{Maximal} (L_{P1}:L_{P9}) * 100\%$

7.6.3. Transmittance = $L_v \text{ on LCD} / L_v \text{ on Backlight} * 100\%$

Note: Measuring machine: BM-7

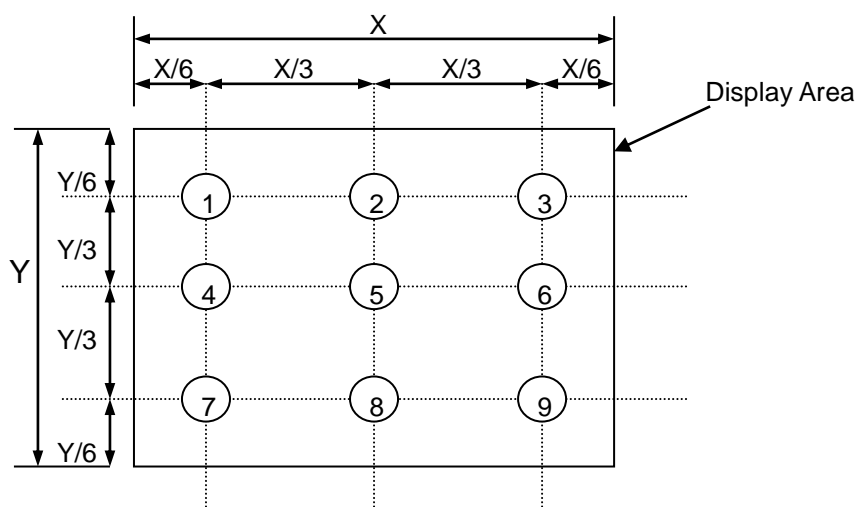

8. Block Diagram and Power Supply

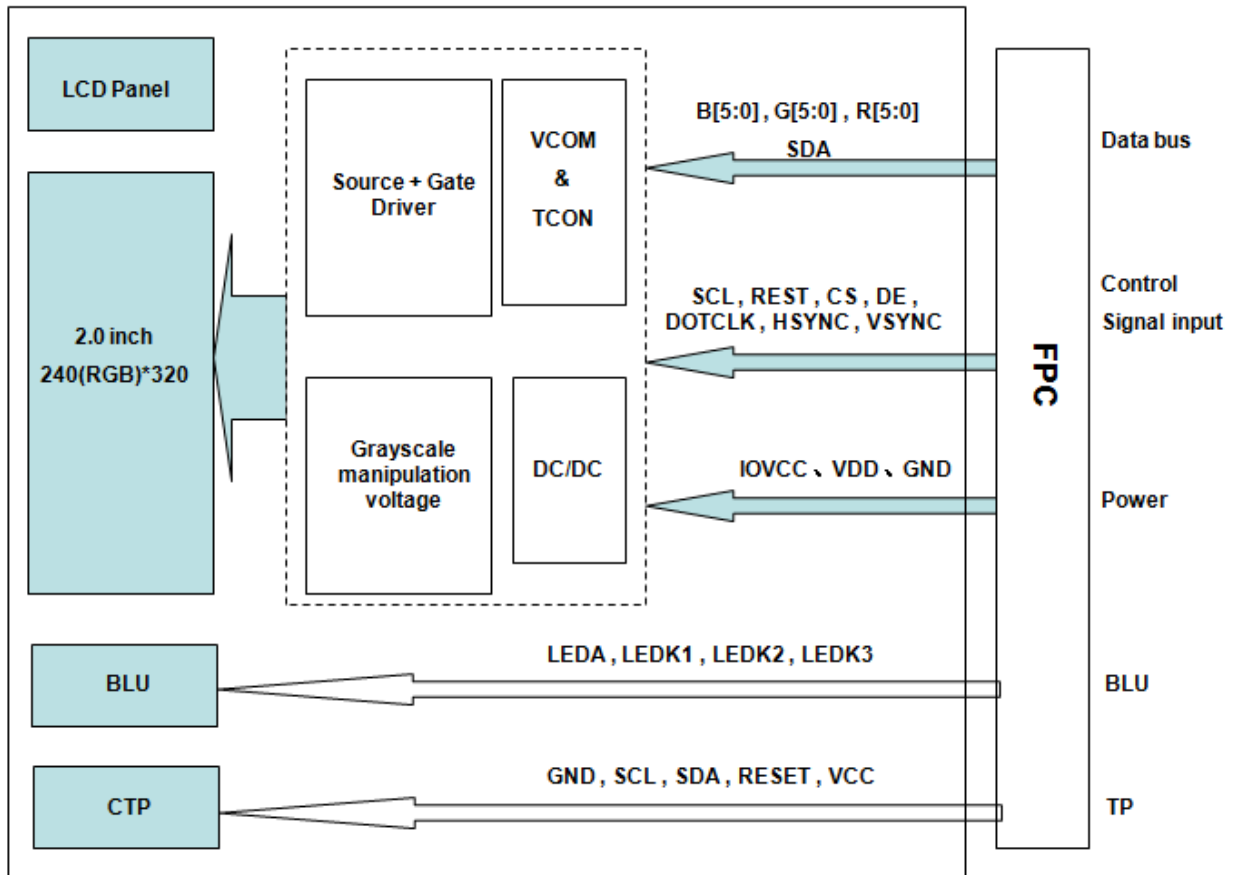

9. Interface Pins Definition**9.1 TFT Pin**

No.	Symbol	Function	Remark
1	GND	Ground.	
2	GND	Ground.	
3	LEDA	LED Anode.	
4	LEDA	LED Anode.	
5	LEDK3	LED Cathode.	
6	LEDK2	LED Cathode.	
7	LEDK1	LED Cathode.	
8	IOVCC	Power Supply Voltage for internal logic circuit	
9	IOVCC	Power Supply Voltage for internal logic circuit	
10	B0	Blue data signal	
11	B1	Blue data signal	
12	B2	Blue data signal	
13	B3	Blue data signal	
14	B4	Blue data signal	
15	B5	Blue data signal	
16	G0	Green data signal	
17	G1	Green data signal	
18	G2	Green data signal	
19	G3	Green data signal	
20	G4	Green data signal	
21	G5	Green data signal	
22	R0	Red data signal	
23	R1	Red data signal	
24	R2	Red data signal	
25	R3	Red data signal	
26	R4	Red data signal	
27	R5	Red data signal	
28	SDA	Serial data input.	
29	SCL	Serial clock.	
30	REST	Reset signal	
31	CS	Chip select signal.	
32	DE	Data enable signal.	
33	DOTCLK	Pixel clock signal in RGB I/F mode	
34	HSYNC	Horizontal sync. Signal in RGB I/F mode	
35	VSYNC	Vertical sync. Signal in RGB I/F mode	
36	VDD	Power supply.	
37	VDD	Power supply.	
38	GND	Ground.	
39	GND	Ground.	

9.2 CTP PIN

No.	Symbol	Function	Remark
1	GND	Ground	
2	SCL	Clock	
3	SDA	Data	
4	INT	Interrupt	
5	RESET	Reset	
6	VCC	Power supply	

10. Timing Characteristics

10.1. Display Serial Interface Timing Characteristics (3-line SPI system)

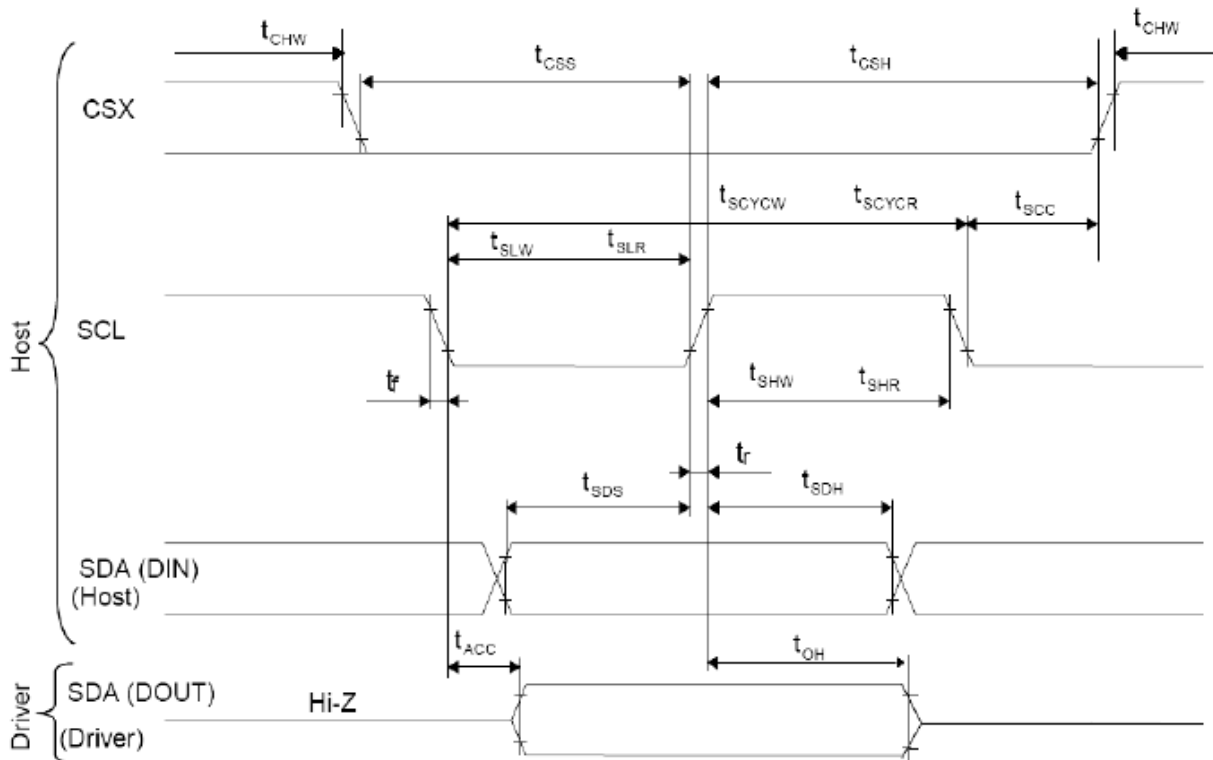

Signal	Symbol	Parameter	min	max	Unit	Description
SCL	tscycw	Serial Clock Cycle (Write)	100	-	ns	
	tshw	SCL "H" Pulse Width (Write)	40	-	ns	
	tslw	SCL "L" Pulse Width (Write)	40	-	ns	
	tscycr	Serial Clock Cycle (Read)	150	-	ns	
	tshr	SCL "H" Pulse Width (Read)	60	-	ns	
	tslr	SCL "L" Pulse Width (Read)	60	-	ns	
SDA / SDI (Input)	tsds	Data setup time (Write)	30	-	ns	
	tsdh	Data hold time (Write)	30	-	ns	
SDA / SDO (Output)	tacc	Access time (Read)	10	-	ns	
	toh	Output disable time (Read)	10	50	ns	
CSX	tsc	SCL-CSX	20	-	ns	
	tchw	CSX "H" Pulse Width	40	-	ns	
	tcss	CSX-SCL Time	60	-	ns	
	tch		65	-	ns	

Note: $T_a = 25\text{ }^\circ\text{C}$, $V_{DDI}=1.65\text{V to }3.3\text{V}$, $V_{CI}=2.5\text{V to }3.3\text{V}$, $AGND=VSS=0\text{V}$

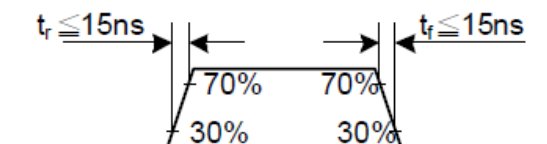

10.2.Parallel 18/16/6-bit RGB Interface Timing Characteristics

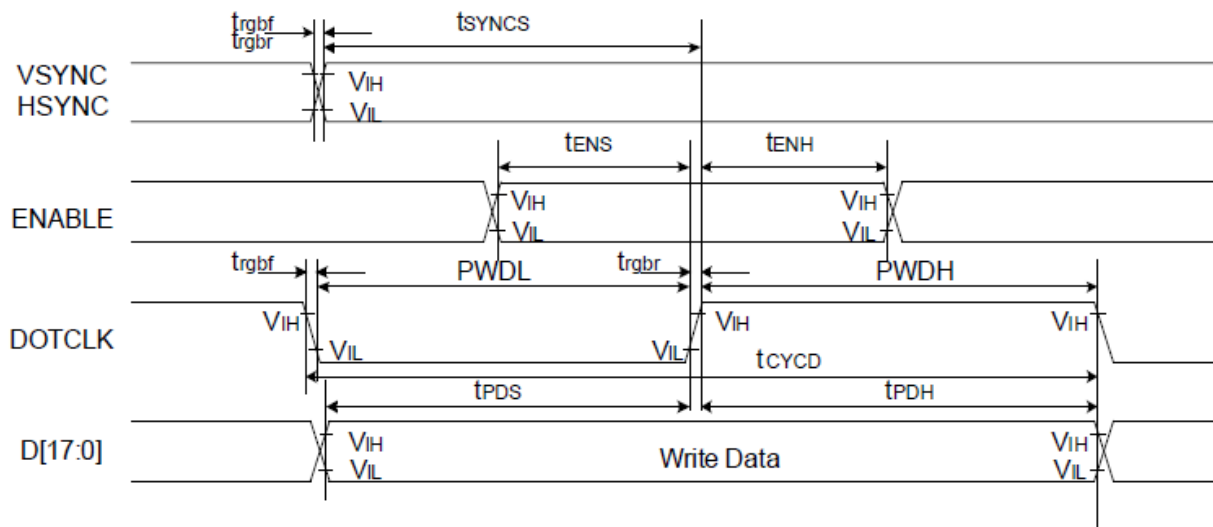

Signal	Symbol	Parameter	min	max	Unit	Description	
VSYNC / HSYNC	t_{SYNCS}	VSYNC/HSYNC setup time	15	-	ns	18/16-bit bus RGB interface mode	
	t_{SYNCH}	VSYNC/HSYNC hold time	15	-	ns		
DE	t_{ENS}	DE setup time	15	-	ns		
	t_{ENH}	DE hold time	15	-	ns		
D[17:0]	t_{POS}	Data setup time	15	-	ns		
	t_{PDH}	Data hold time	15	-	ns		
DOTCLK	$PWDH$	DOTCLK high-level period	15	-	ns		
	$PWDL$	DOTCLK low-level period	15	-	ns		
	t_{CYCD}	DOTCLK cycle time	100	-	ns		
	t_{rgbr}, t_{rgbf}	DOTCLK,HSYNC,VSYNC rise/fall time	-	15	ns		
VSYNC / HSYNC	t_{SYNCS}	VSYNC/HSYNC setup time	15	-	ns		6-bit bus RGB interface mode
	t_{SYNCH}	VSYNC/HSYNC hold time	15	-	ns		
DE	t_{ENS}	DE setup time	15	-	ns		
	t_{ENH}	DE hold time	15	-	ns		
D[17:0]	t_{POS}	Data setup time	15	-	ns		
	t_{PDH}	Data hold time	15	-	ns		
DOTCLK	$PWDH$	DOTCLK high-level pulse period	15	-	ns		
	$PWDL$	DOTCLK low-level pulse period	15	-	ns		
	t_{CYCD}	DOTCLK cycle time	50	-	ns		
	t_{rgbr}, t_{rgbf}	DOTCLK,HSYNC,VSYNC rise/fall time	-	15	ns		

Note: $T_a = -30$ to 70 °C, $V_{DDI} = 1.65V$ to $3.3V$, $V_{CI} = 2.5V$ to $3.3V$, $AGND = V_{SS} = 0V$

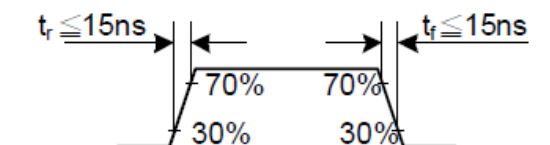

10.3.Reset timing

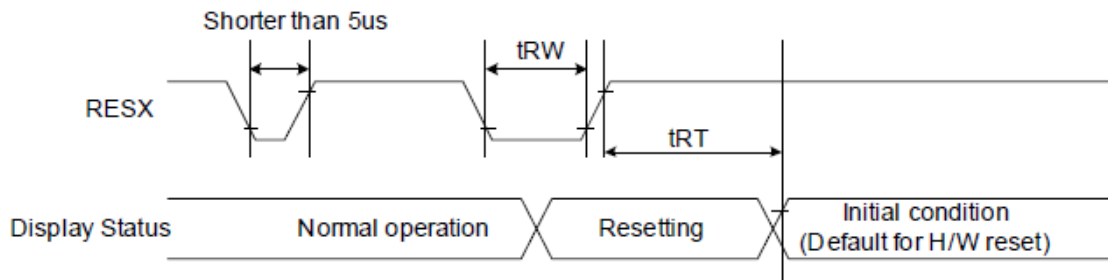

Signal	Symbol	Parameter	Min	Max	Unit
RESX	tRW	Reset pulse duration	10		uS
	tRT	Reset cancel		5 (note 1,5)	mS
				120 (note 1,6,7)	mS

Note 1: The reset cancel includes also required time for loading ID bytes, VCOM setting and other settings from NV memory to registers. This loading is done every time when there is HW reset cancel time (tRT) within 5 ms after a rising edge of RESX.

Note 2: Spike due to an electrostatic discharge on RESX line does not cause irregular system reset according to the table below: -

RESX Pulse	Action
Shorter than 5us	Reset Rejected
Longer than 10us	Reset
Between 5us and 10us	Reset starts

Note 3: During the Resetting period, the display will be blanked (The display is entering blanking sequence, which maximum time is 120 ms, when Reset Starts in Sleep Out –mode. The display remains the blank state in Sleep In -mode.) And then return to Default condition for Hardware Reset.

Note 4: Spike Rejection also applies during a valid reset pulse as shown below:

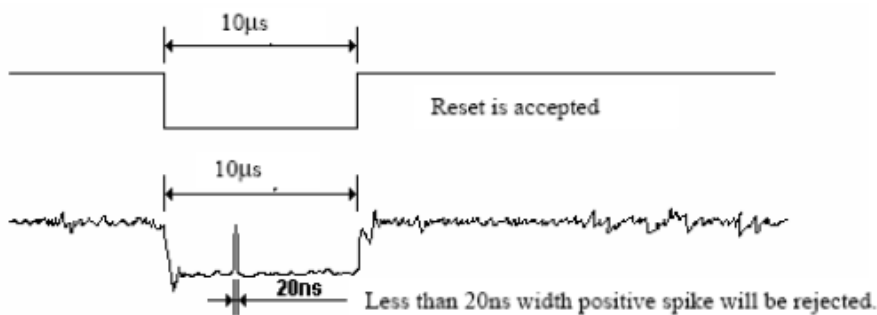

Note 5: When Reset applied during Sleep In Mode.

Note 6: When Reset applied during Sleep Out Mode.

Note 7: It is necessary to wait 5msec after releasing RESX before sending commands. Also Sleep Out command cannot be sent for 120msec.'

11. Quality Assurance

11.1. Purpose

This standard for Quality Assurance assures the quality of LCD module products supplied to customer.

11.2. Standard for Quality Test

11.2.1. Sampling Plan:

GB2828.1-2012

Single sampling, general inspection level II

11.2.2. Sampling Criteria:

Visual inspection: AQL 1.5%

Electrical functional: AQL 0.65%.

11.2.3. Reliability Test:

Detailed requirement refer to Reliability Test Specification.

11.3. Nonconforming Analysis & Disposition

11.3.1. Nonconforming analysis:

11.3.1.1. Customer should provide overall information of non-conforming sample for their complaints.

11.3.1.2. After receipt of detailed information from customer, the analysis of nonconforming parts usually should be finished in one week.

11.3.1.3. If cannot finish the analysis on time, customer will be notified with the progress status.

11.3.2. Disposition of nonconforming:

11.3.2.1. Non-conforming product over PPM level will be replaced.

11.3.2.2. The cause of non-conformance will be analyzed. Corrective action will be discussed and implemented.

11.4. Agreement Items

Shall negotiate with customer if the following situation occurs:

11.4.1. There is any discrepancy in standard of quality assurance.

11.4.2. Additional requirement to be added in product specification.

11.4.3. Any other special problem.

11.5. Standard of the Product Visual Inspection

11.5.1. Appearance inspection:

11.5.1.1. The inspection must be under illumination about 1000 – 1500 lx, and the distance of view must be at 30cm ± 2cm.

11.5.1.2. The viewing angle should be 45° from the vertical line without reflection light or follows customer's viewing angle specifications.

11.5.1.3. Definition of area: A Zone: Active Area, B Zone: Viewing Area,

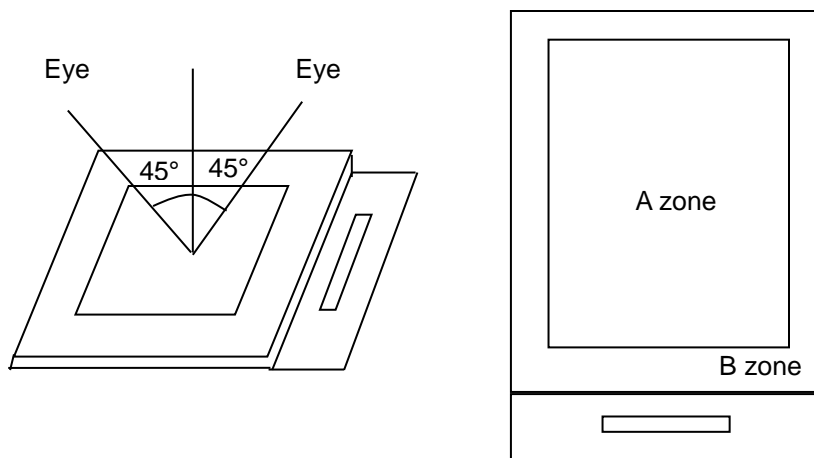

11.5.2. Basic principle:

11.5.2.1. A set of sample to indicate the limit of acceptable quality level must be discussed by both us and customer when there is any dispute happened.

11.5.2.2. New item must be added on time when it is necessary.

11.6. Inspection Specification

No.	Item	Criteria (Unit: mm)																		
01	Black / White spot Foreign material (Round type) Pinholes Stain Particles inside cell. (Minor defect)	<table border="1"> <thead> <tr> <th>Size</th> <th>Area</th> <th>Acc. Qty</th> </tr> </thead> <tbody> <tr> <td>$\phi \leq 0.10$</td> <td></td> <td>Ignore</td> </tr> <tr> <td>$0.10 < \phi \leq 0.15$</td> <td></td> <td>2</td> </tr> <tr> <td>$0.15 < \phi \leq 0.25$</td> <td></td> <td>1</td> </tr> <tr> <td>$0.25 < \phi$</td> <td></td> <td>0</td> </tr> <tr> <td>Total</td> <td></td> <td>2 no include $\phi \leq 0.10$</td> </tr> </tbody> </table> <p>Distance between 2 defects should more than 3mm apart.</p>	Size	Area	Acc. Qty	$\phi \leq 0.10$		Ignore	$0.10 < \phi \leq 0.15$		2	$0.15 < \phi \leq 0.25$		1	$0.25 < \phi$		0	Total		2 no include $\phi \leq 0.10$
Size	Area	Acc. Qty																		
$\phi \leq 0.10$		Ignore																		
$0.10 < \phi \leq 0.15$		2																		
$0.15 < \phi \leq 0.25$		1																		
$0.25 < \phi$		0																		
Total		2 no include $\phi \leq 0.10$																		
02	Electrical Defect (Minor defect)	<table border="1"> <thead> <tr> <th></th> <th>Display Area</th> <th>Total</th> <th></th> </tr> </thead> <tbody> <tr> <td>Bright dot</td> <td>0</td> <td>0</td> <td rowspan="3">Note1</td> </tr> <tr> <td>Dark dot</td> <td>$N \leq 2$</td> <td>$N \leq 2$</td> </tr> <tr> <td>Total dot</td> <td>$N \leq 2$</td> <td>$N \leq 2$</td> </tr> <tr> <td>Mura</td> <td colspan="2">Not visible through 5% ND filters.</td> <td>Note2</td> </tr> </tbody> </table> <p>Remark: 1. Bright dot caused by scratch and foreign object accords to item 1.</p>		Display Area	Total		Bright dot	0	0	Note1	Dark dot	$N \leq 2$	$N \leq 2$	Total dot	$N \leq 2$	$N \leq 2$	Mura	Not visible through 5% ND filters.		Note2
	Display Area	Total																		
Bright dot	0	0	Note1																	
Dark dot	$N \leq 2$	$N \leq 2$																		
Total dot	$N \leq 2$	$N \leq 2$																		
Mura	Not visible through 5% ND filters.		Note2																	

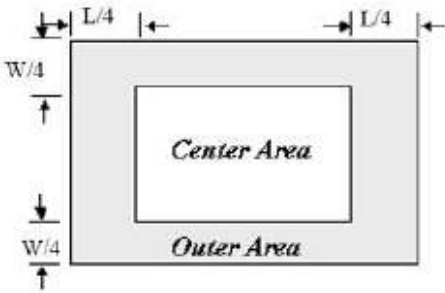
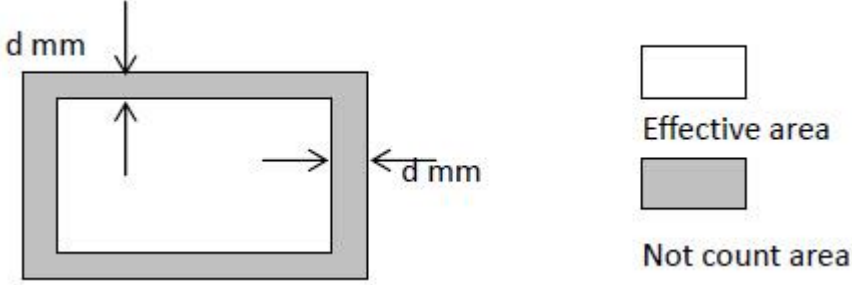
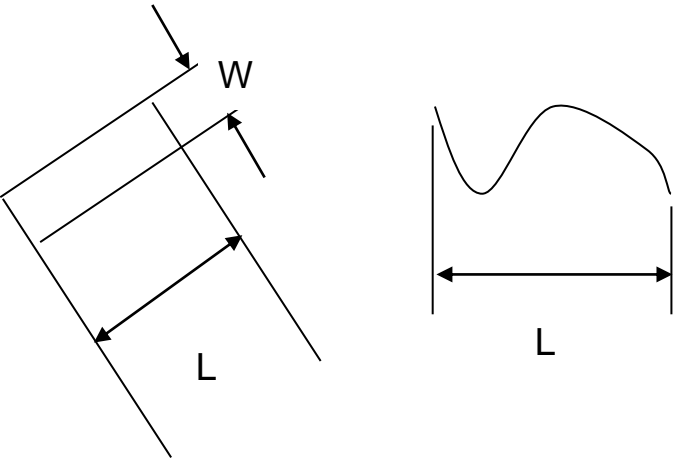
<p>03</p>	<p>Inactive Area (Minor defect)</p>	<p>Line Criteria: $L \leq 1\text{mm}$, $W \leq 0.1\text{mm}$, Dot Criteria: Please refer to Note 1,2&3</p> <p>Note1: Definition of Area</p>  <p>Note 2:</p> <table border="1" data-bbox="523 683 1364 855"> <thead> <tr> <th>Size</th> <th>Inactive dot</th> <th>Center</th> <th>Outer</th> <th>Total</th> <th>Remark</th> </tr> </thead> <tbody> <tr> <td>All</td> <td>$\Phi < 0.2\text{mm}$</td> <td colspan="4">Is not counted</td> </tr> <tr> <td><6"</td> <td>$0.2 \leq \Phi \leq 0.3\text{mm}$ $L \leq 1\text{mm}, W \leq 0.1\text{mm}$</td> <td>$N \leq 1$</td> <td>$N \leq 2$</td> <td>$N \leq 3$</td> <td></td> </tr> </tbody> </table> <p>Note3: Inactive area $D < 0.2\text{mm}$ is not counted without appearance observation.</p> <p>Remark: Effective area is from the POL cutting side to 0.5mm of inside. This is no count area. Other part is effective area. In no count area, any defect can ignore. In effective area, have to judge from above-mentioned specification.</p> 	Size	Inactive dot	Center	Outer	Total	Remark	All	$\Phi < 0.2\text{mm}$	Is not counted				<6"	$0.2 \leq \Phi \leq 0.3\text{mm}$ $L \leq 1\text{mm}, W \leq 0.1\text{mm}$	$N \leq 1$	$N \leq 2$	$N \leq 3$	
Size	Inactive dot	Center	Outer	Total	Remark															
All	$\Phi < 0.2\text{mm}$	Is not counted																		
<6"	$0.2 \leq \Phi \leq 0.3\text{mm}$ $L \leq 1\text{mm}, W \leq 0.1\text{mm}$	$N \leq 1$	$N \leq 2$	$N \leq 3$																
<p>04</p>	<p>Black and White line Scratch Foreign material (Line type) (Minor defect)</p>																			

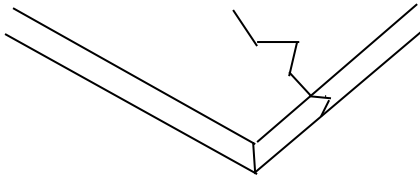
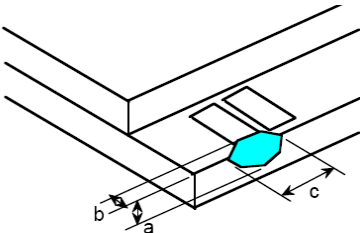
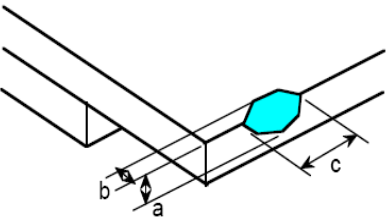
		<table border="1"> <thead> <tr> <th>Length</th> <th>Width</th> <th>Acc. Qty</th> </tr> </thead> <tbody> <tr> <td>/</td> <td>$W \leq 0.03$</td> <td>Ignore</td> </tr> <tr> <td>$L \leq 2.5$</td> <td>$0.03 < W \leq 0.05$</td> <td>3</td> </tr> <tr> <td>$L \leq 2.5$</td> <td>$0.05 < W \leq 0.10$</td> <td>2</td> </tr> <tr> <td>/</td> <td>$0.1 < W$</td> <td>0</td> </tr> <tr> <td colspan="2">Total</td> <td>3</td> </tr> </tbody> </table> <p>Distance between 2 defects should more than 3mm apart. Scratches not viewable through the back of the display are acceptable.</p>	Length	Width	Acc. Qty	/	$W \leq 0.03$	Ignore	$L \leq 2.5$	$0.03 < W \leq 0.05$	3	$L \leq 2.5$	$0.05 < W \leq 0.10$	2	/	$0.1 < W$	0	Total		3
Length	Width	Acc. Qty																		
/	$W \leq 0.03$	Ignore																		
$L \leq 2.5$	$0.03 < W \leq 0.05$	3																		
$L \leq 2.5$	$0.05 < W \leq 0.10$	2																		
/	$0.1 < W$	0																		
Total		3																		
05	Glass Crack (Minor defect)	 <p>Crack is potential to enlarge, any type is not allowed.</p>																		
06	Glass Chipping Pad Area: (Minor defect)	 <table border="1"> <thead> <tr> <th>Length and Width</th> <th>Acc. Qty</th> </tr> </thead> <tbody> <tr> <td>$c > 3.0, b < 1.0$</td> <td>1</td> </tr> <tr> <td>$c < 3.0, b < 1.0$</td> <td>3</td> </tr> <tr> <td colspan="2">$a < \text{Glass Thickness}$</td> </tr> </tbody> </table>	Length and Width	Acc. Qty	$c > 3.0, b < 1.0$	1	$c < 3.0, b < 1.0$	3	$a < \text{Glass Thickness}$											
Length and Width	Acc. Qty																			
$c > 3.0, b < 1.0$	1																			
$c < 3.0, b < 1.0$	3																			
$a < \text{Glass Thickness}$																				
07	Glass Chipping Rear of Pad Area: (Minor defect)	 <table border="1"> <thead> <tr> <th>Length and Width</th> <th>Acc. Qty</th> </tr> </thead> <tbody> <tr> <td>$c > 3.0, b < 1.0$</td> <td>1</td> </tr> <tr> <td>$c < 3.0, b < 1.0$</td> <td>2</td> </tr> <tr> <td>$c < 3.0, b < 0.5$</td> <td>4</td> </tr> <tr> <td colspan="2">$a < \text{Glass Thickness}$</td> </tr> </tbody> </table>	Length and Width	Acc. Qty	$c > 3.0, b < 1.0$	1	$c < 3.0, b < 1.0$	2	$c < 3.0, b < 0.5$	4	$a < \text{Glass Thickness}$									
Length and Width	Acc. Qty																			
$c > 3.0, b < 1.0$	1																			
$c < 3.0, b < 1.0$	2																			
$c < 3.0, b < 0.5$	4																			
$a < \text{Glass Thickness}$																				

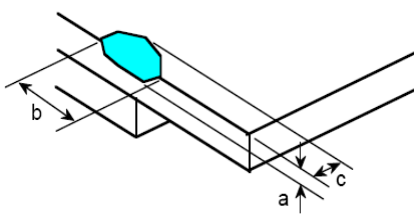
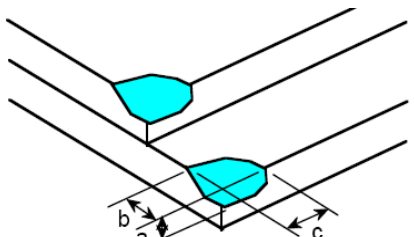
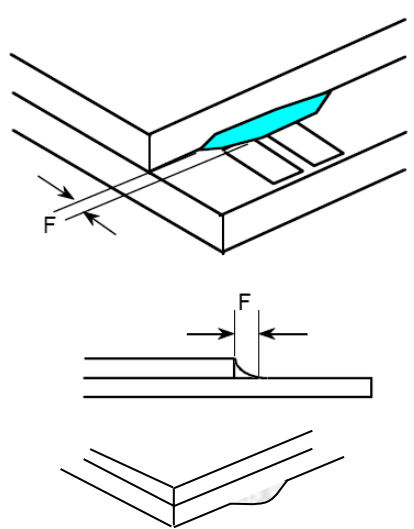
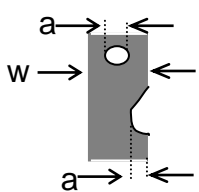
<p>08</p>	<p>Glass Chipping Except Pad Area: (Minor defect)</p> 	<table border="1"> <thead> <tr> <th>Length and Width</th> <th>Acc. Qty</th> </tr> </thead> <tbody> <tr> <td>$c > 3.0, b < 1.0$</td> <td>1</td> </tr> <tr> <td>$c < 3.0, b < 1.0$</td> <td>2</td> </tr> <tr> <td>$c < 3.0, b < 0.5$</td> <td>4</td> </tr> <tr> <td colspan="2" style="text-align: center;">$a < \text{Glass Thickness}$</td> </tr> </tbody> </table>	Length and Width	Acc. Qty	$c > 3.0, b < 1.0$	1	$c < 3.0, b < 1.0$	2	$c < 3.0, b < 0.5$	4	$a < \text{Glass Thickness}$	
Length and Width	Acc. Qty											
$c > 3.0, b < 1.0$	1											
$c < 3.0, b < 1.0$	2											
$c < 3.0, b < 0.5$	4											
$a < \text{Glass Thickness}$												
<p>09</p>	<p>Glass Corner Chipping: (Minor defect)</p> 	<table border="1"> <thead> <tr> <th>Length and Width</th> <th>Acc. Qty</th> </tr> </thead> <tbody> <tr> <td>$c < 3.0, b < 3.0$</td> <td>Ignore</td> </tr> <tr> <td colspan="2" style="text-align: center;">$a < \text{Glass Thickness}$</td> </tr> </tbody> </table>	Length and Width	Acc. Qty	$c < 3.0, b < 3.0$	Ignore	$a < \text{Glass Thickness}$					
Length and Width	Acc. Qty											
$c < 3.0, b < 3.0$	Ignore											
$a < \text{Glass Thickness}$												
<p>10</p>	<p>Glass Burr: (Minor defect)</p> 	<table border="1"> <thead> <tr> <th>Length</th> <th>Acc. Qty</th> </tr> </thead> <tbody> <tr> <td>$F < 1.0$</td> <td>Ignore</td> </tr> </tbody> </table> <p>Glass burr don't affect assemble and module dimension.</p>	Length	Acc. Qty	$F < 1.0$	Ignore						
Length	Acc. Qty											
$F < 1.0$	Ignore											
<p>11</p>	<p>FPC Defect: (Minor defect)</p> 	<p>11.1 Dent, pinhole width $a < w/3$. (w: circuitry width.)</p> <p>11.2 Open circuit is unacceptable.</p> <p>11.3 No oxidation, contamination and distortion.</p>										

12	Bubble on Polarizer (Minor defect)	Diameter		Acc. Qty
		$\varphi \leq 0.20$		Ignore
		$0.20 < \varphi \leq 0.30$		4
		$0.30 < \varphi \leq 0.50$		1
		$0.50 < \varphi$		None
13	Dent on Polarizer (Minor defect)	Diameter		Acc. Qty
		$\varphi \leq 0.20$		Ignore
		$0.20 < \varphi \leq 0.30$		4
		$0.30 < \varphi \leq 0.50$		1
		$0.50 < \varphi$		None
14	Bezel	14.1 No rust, distortion on the Bezel. 14.2 No visible fingerprints, stains or other contamination.		
15	PCB	15.1 No distortion or contamination on PCB terminals. 15.2 All components on PCB must same as documented on the BOM/component layout. 15.3 Follow IPC-A-600F.		
16	Soldering	Follow IPC-A-610C standard		
17	Electrical Defect (Major defect)	The below defects must be rejected. 17.1 Missing vertical / horizontal segment, 17.2 Abnormal Display. 17.3 No function or no display. 17.4 Current exceeds product specifications. 17.5 LCD viewing angle defect. 17.6 No Backlight. 17.7 Dark Backlight. 17.8 Touch Panel no function.		

Remark: LCD Panel Broken shall be rejected. Defect out of LCD viewing area is acceptable.

Inspection Specification for the Capacitive Touch Panel

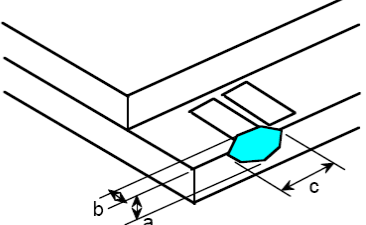
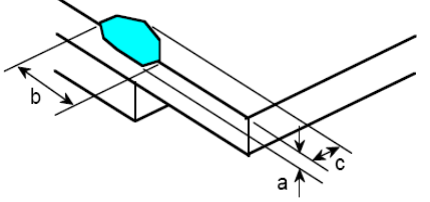
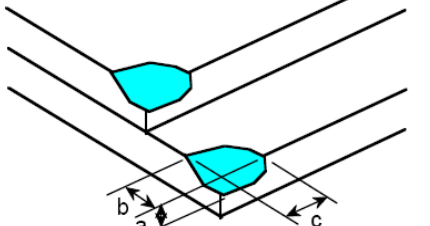
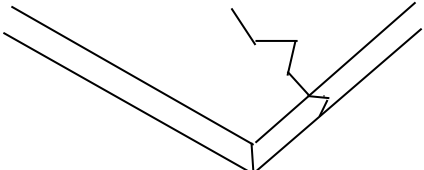
<p>01</p>	<p>Chipping Pad Area(Not include the cover lens): (Minor defect)</p> 	<p>The chip is seriously influence the product's function, any type is not allowed.</p>						
<p>02</p>	<p>Chipping Except Pad Area(Not include the cover lens): (Minor defect)</p> 	<table border="1" data-bbox="880 763 1353 891"> <thead> <tr> <th>Length and Width</th> <th>Acc. Qty</th> </tr> </thead> <tbody> <tr> <td>$c < 1.5, b < 1$</td> <td>$N \leq 5$</td> </tr> <tr> <td colspan="2">$a < 1/2$ Glass Thickness</td> </tr> </tbody> </table>	Length and Width	Acc. Qty	$c < 1.5, b < 1$	$N \leq 5$	$a < 1/2$ Glass Thickness	
Length and Width	Acc. Qty							
$c < 1.5, b < 1$	$N \leq 5$							
$a < 1/2$ Glass Thickness								
<p>03</p>	<p>Corner Chipping(Not include the cover lens): (Minor defect)</p> 	<table border="1" data-bbox="880 1137 1353 1265"> <thead> <tr> <th>Length and Width</th> <th>Acc. Qty</th> </tr> </thead> <tbody> <tr> <td>$c < 1.5, b < 0.5$</td> <td>Ignore</td> </tr> <tr> <td colspan="2">$a < 1/2$ Glass Thickness</td> </tr> </tbody> </table>	Length and Width	Acc. Qty	$c < 1.5, b < 0.5$	Ignore	$a < 1/2$ Glass Thickness	
Length and Width	Acc. Qty							
$c < 1.5, b < 0.5$	Ignore							
$a < 1/2$ Glass Thickness								
<p>04</p>	<p>Crack: (Minor defect)</p>	 <p>Crack is potential to enlarge, any type is not allowed.</p>						
<p>05</p>	<p>Cover lens must be without any chips, cracks or other damage when viewed from the front.</p>							

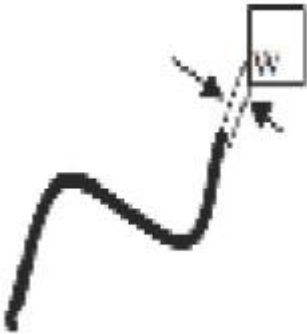
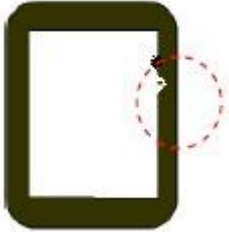
<p>06</p>	<p>Same/Different color spot</p> 	<p>D: Diameter W: width L: length</p> <table border="1" data-bbox="890 230 1342 360"> <thead> <tr> <th>Diameter</th> <th>Acc. Qty</th> </tr> </thead> <tbody> <tr> <td>D < 0.20</td> <td>Ignore</td> </tr> </tbody> </table> <p>Active Area:</p> <table border="1" data-bbox="890 412 1342 629"> <thead> <tr> <th>Diameter</th> <th>Acc. Qty</th> </tr> </thead> <tbody> <tr> <td>0.20 < D ≤ 0.30</td> <td>2</td> </tr> <tr> <td>0.30 < D ≤ 0.50</td> <td>1</td> </tr> <tr> <td>D > 0.5</td> <td>NG</td> </tr> </tbody> </table> <p>Viewing Area :</p> <table border="1" data-bbox="890 680 1342 916"> <thead> <tr> <th>Diameter</th> <th>Acc. Qty</th> </tr> </thead> <tbody> <tr> <td>D < 0.20</td> <td>Ignore</td> </tr> <tr> <td>0.20 < D ≤ 0.5</td> <td>3</td> </tr> <tr> <td>D > 0.5</td> <td>NG</td> </tr> </tbody> </table> <p>Distance between 2 defects should more than 15mm apart.</p>	Diameter	Acc. Qty	D < 0.20	Ignore	Diameter	Acc. Qty	0.20 < D ≤ 0.30	2	0.30 < D ≤ 0.50	1	D > 0.5	NG	Diameter	Acc. Qty	D < 0.20	Ignore	0.20 < D ≤ 0.5	3	D > 0.5	NG
Diameter	Acc. Qty																					
D < 0.20	Ignore																					
Diameter	Acc. Qty																					
0.20 < D ≤ 0.30	2																					
0.30 < D ≤ 0.50	1																					
D > 0.5	NG																					
Diameter	Acc. Qty																					
D < 0.20	Ignore																					
0.20 < D ≤ 0.5	3																					
D > 0.5	NG																					
<p>07</p>	<p>Cover lens line Scratch</p> 	<table border="1" data-bbox="794 1061 1418 1368"> <thead> <tr> <th>Length</th> <th>Width</th> <th>Acc. Qty</th> </tr> </thead> <tbody> <tr> <td>/</td> <td>W ≤ 0.08mm</td> <td>Ignore</td> </tr> <tr> <td>L ≤ 5</td> <td>0.08 < W ≤ 0.15</td> <td>2</td> </tr> <tr> <td>L ≤ 3</td> <td>0.15 < W ≤ 0.20</td> <td>1</td> </tr> <tr> <td>-</td> <td>W > 0.2</td> <td>NG</td> </tr> <tr> <td>L > 5</td> <td>-</td> <td>NG</td> </tr> </tbody> </table> <p>Distance between 2 defects should more than 15mm apart.</p>	Length	Width	Acc. Qty	/	W ≤ 0.08mm	Ignore	L ≤ 5	0.08 < W ≤ 0.15	2	L ≤ 3	0.15 < W ≤ 0.20	1	-	W > 0.2	NG	L > 5	-	NG		
Length	Width	Acc. Qty																				
/	W ≤ 0.08mm	Ignore																				
L ≤ 5	0.08 < W ≤ 0.15	2																				
L ≤ 3	0.15 < W ≤ 0.20	1																				
-	W > 0.2	NG																				
L > 5	-	NG																				
<p>08</p>	<p>Printing sawtooth</p> 	<table border="1" data-bbox="794 1576 1418 1794"> <thead> <tr> <th>Length</th> <th>Width</th> <th>Acc. Qty</th> </tr> </thead> <tbody> <tr> <td>/</td> <td>W ≤ 0.2mm</td> <td>2</td> </tr> <tr> <td>L ≤ 2</td> <td>0.2 < W ≤ 0.3</td> <td>1</td> </tr> <tr> <td>L ≤ 2</td> <td>W > 0.3</td> <td>NG</td> </tr> </tbody> </table>	Length	Width	Acc. Qty	/	W ≤ 0.2mm	2	L ≤ 2	0.2 < W ≤ 0.3	1	L ≤ 2	W > 0.3	NG								
Length	Width	Acc. Qty																				
/	W ≤ 0.2mm	2																				
L ≤ 2	0.2 < W ≤ 0.3	1																				
L ≤ 2	W > 0.3	NG																				

11.7. Classification of Defects

11.7.1. Visual defects (Except no / wrong label) are treated as minor defect and electrical defect is major.

11.7.2. Two minor defects are equal to one major in lot sampling inspection.

11.8. Identification/marketing criteria

Any unit with illegible / wrong /double or no marking/ label shall be rejected.

11.9. Packaging

11.9.1. There should be no damage of the outside carton box, each packaging box should have one identical label.

11.9.2. Modules inside package box should have compliant mark.

11.9.3. All direct package materials shall offer ESD protection

Note1: Bright dot is defined as the defective area of the dot is larger than 50% of one sub-pixel area.

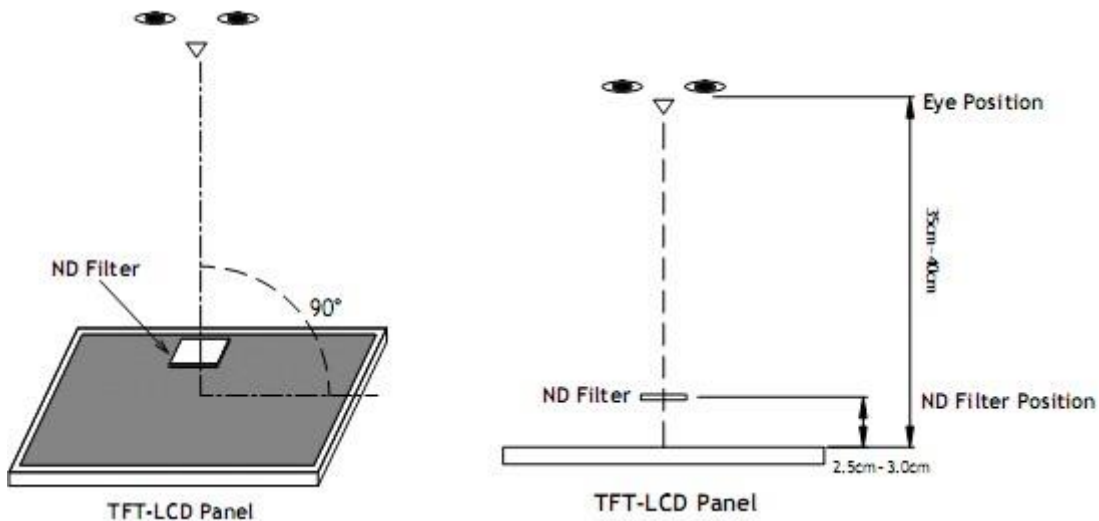

Bright dot: The bright dot size defect at black display pattern. It can be recognized by 2% transparency of filter when the distance between eyes and panel is $350\text{mm} \pm 50\text{mm}$.

Dark dot: Cyan, Magenta or Yellow dot size defect at white display pattern. It can be recognized by 5% transparency of filter when the distance between eyes and panel is $350\text{mm} \pm 50\text{mm}$.

Note2: Mura on display which appears darker / brighter against background brightness on parts of display area.

12. Reliability Specification

No	Item	Condition	Quantity	Criteria
1	High Temperature Operating	+70°C, 96Hrs	2	GB/T2423.2-2008
2	Low Temperature Operating	-20°C, 96Hrs	2	GB/T2423.1-2008
3	High Humidity Storage	+50°C, 90%RH, 96Hrs	2	GB/T2423.3-2016
4	High Temperature Storage	+80°C, 96Hrs	2	GB/T2423.2-2008
5	Low Temperature Storage	-30°C, 96Hrs	2	GB/T2423.1-2008
6	Thermal Cycling Test Storage	-20°C, 60min~+70°C, 60min, 20 cycles.	2	GB/T2423.22-2012
7	Packing vibration	Frequency range:10Hz~50Hz Acceleration of gravity:5G X, Y, Z 30 min for each direction.	2	GB/T5170.14-2009
8	Electrical Static Discharge	Air: ±8KV 150pF/330 Ω 5 times	2	GB/T17626.2-2018
		Contact: ±4KV 150pF/330 Ω 5 times		
9	Drop Test (Packaged)	Height:80 cm,1 corner, 3 edges, 6 surfaces.	2	GB/T2423.8-1995

Note1. No deflection cosmetic and operational function allowable.

Note2. Total current Consumption should be below double of initial value

13. Precautions and Warranty

13.1. Safety

- 13.1.1. The liquid crystal in the LCD is poisonous. Do not put it in your mouth. If the liquid crystal touches your skin or clothes, wash it off immediately using soap and water.
- 13.1.2. Since the liquid crystal cells are made of glass, do not apply strong impact on them. Handle with care.

13.2. Handling

- 13.2.1. Reverse and use within ratings in order to keep performance and prevent damage.
- 13.2.2. Do not wipe the polarizer with dry cloth, as it might cause scratch. If the surface of the LCD needs to be cleaned, wipe it swiftly with cotton or other soft cloth soaked with petroleum IPA, do not use other chemicals.

13.3. Storage

- 13.3.1. Do not store the LCD module beyond the specified temperature ranges.
- 13.3.2. Strong light exposure causes degradation of polarizer and color filter

13.4. Metal Pin (Apply to Products with Metal Pins)

13.4.1. Pins of LCD and Backlight

- 13.4.1.1. Solder tip can touch and press on the tip of Pin LEAD during the soldering

13.4.1.2. Recommended Soldering Conditions

Solder Type: Sn96.3~94-Ag3.3~4.3-Cu0.4~1.1

Maximum Solder Temperature: 370°C

Maximum Solder Time: 3s at the maximum temperature

Recommended Soldering Temp: 350±20°C

Typical Soldering Time: ≤3s

13.4.1.3. Solder Wetting

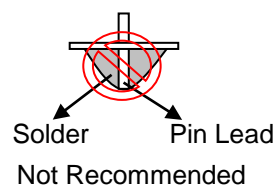
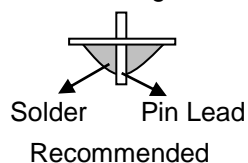

13.4.2. Pins of EL

- 13.4.2.1. Solder tip can touch and press on the tip of EL leads during soldering.
- 13.4.2.2. No Solder Paste on the soldering pad on the motherboard is recommended.

13.4.2.3. Recommended Soldering Conditions

Solder type: Nippon Alimit Leadfree SR-34, size 0.5mm

Recommended Solder Temperature: 270~290°C

Typical Soldering Time: ≤2s

Minimum solder distance from EL lamp (body):2.0mm

- 13.4.2.4. No horizontal press on the EL leads during soldering.

- 13.4.2.5. 180° bend EL leads three times is not allowed.

13.4.2.6. Solder Wetting

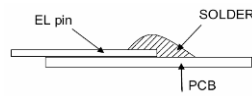

Recommended

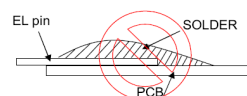

Not Recommended

13.4.2.7. The type of the solder iron:

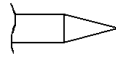

Recommended

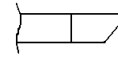

Not Recommended

13.4.2.8. Solder Pad

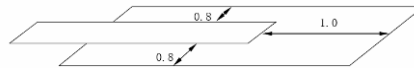

13.5. Operation

- 13.5.1. Do not drive LCD with DC voltage
- 13.5.2. Response time will increase below lower temperature
- 13.5.3. Display may change color with different temperature
- 13.5.4. Mechanical disturbance during operation, such as pressing on the display area, may cause the segments to appear “fractured”.
- 13.5.5. Do not connect or disconnect the LCM to or from the system when power is on.
- 13.5.6. Never use the LCM under abnormal condition of high temperature and high humidity.
- 13.5.7. Module has high frequency circuits. Sufficient suppression to the electromagnetic interface shall be done by system manufacturers. Grounding and shielding methods may be important to minimize the interference.
- 13.5.8. Do not display the fixed pattern for long time (we suggest the time not longer than one hour) because it may develop image sticking due to the TFT structure.

13.6. Static Electricity

- 13.6.1. CMOS LSIs are equipped in this unit, so care must be taken to avoid the electro-static charge, by ground human body, etc.
- 13.6.2. The normal static prevention measures should be observed for work clothes and benches.
- 13.6.3. The module should be kept into anti-static bags or other containers resistant to static for storage.

13.7. Limited Warranty

- 13.7.1. Our warranty liability is limited to repair and/or replacement. We will not be responsible for any consequential loss.
- 13.7.2. If possible, we suggest customer to use up all modules in six months. If the module storage time over twelve months, we suggest that recheck it before the module be used.
- 13.7.3. After the product shipped, any product quality issues must be feedback within three months, otherwise, we will not be responsible for the subsequent or consequential events.

14. Outline Drawing

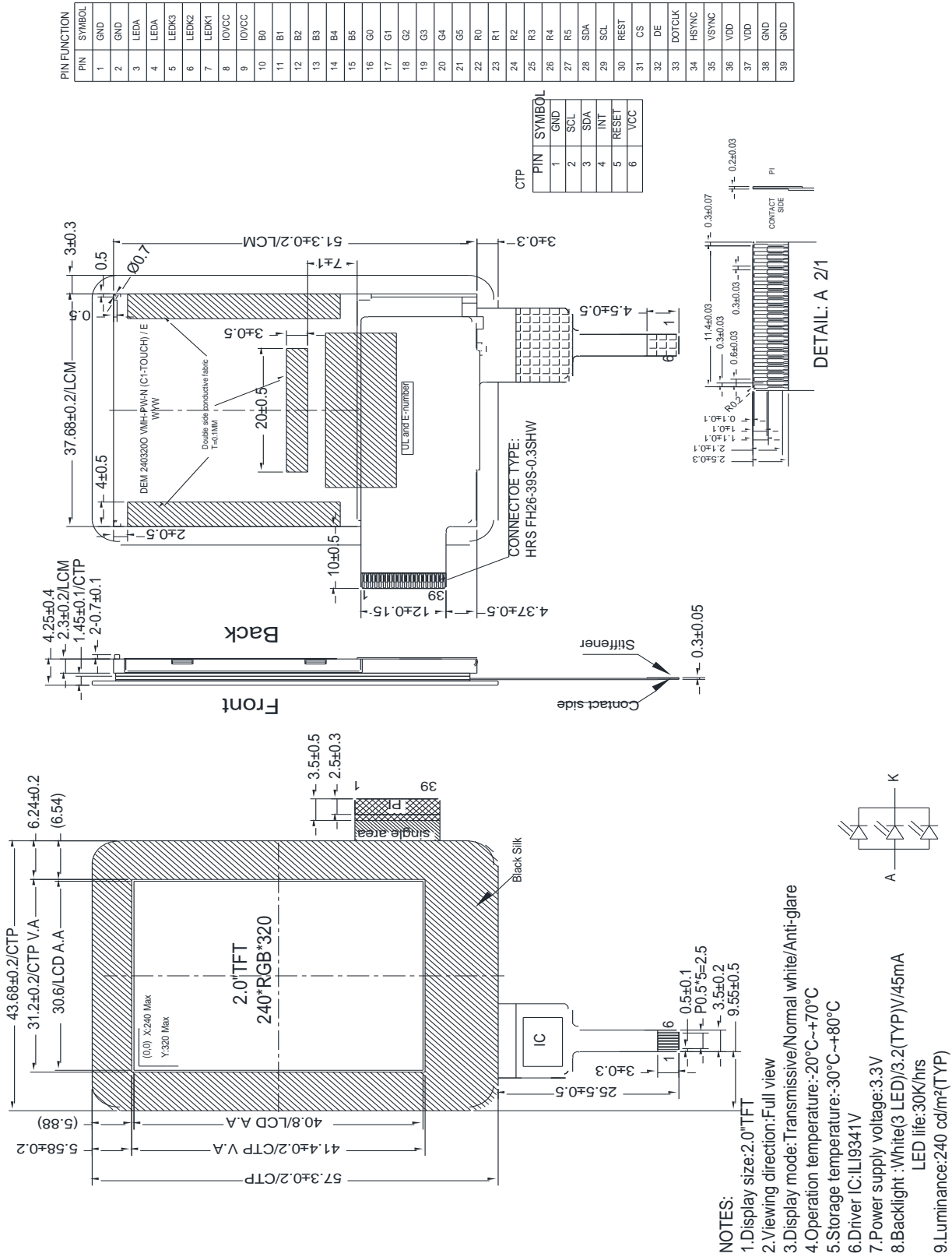

- NOTES:
1. Display size: 2.0" TFT
 2. Viewing direction: Full view
 3. Display mode: Transmissive/Normal white/Anti-glare
 4. Operation temperature: -20°C~+70°C
 5. Storage temperature: -30°C~+80°C
 6. Driver IC: ILI9341V
 7. Power supply voltage: 3.3V
 8. Backlight : White(3 LED)/3.2(TYP)/V45mA
LED life: 30K/hrs
 9. Luminance: 240 cd/m²(TYP)
 10. ROHS must be complied
- * Unspecification tolerance are ±0.2mm
 * The dimension with mark brackets "()" just for reference