

THIS DOCUMENT IS THE PROPERTY OF
KEYSTONE ELECTRONICS CORP. AND
SHALL NOT BE REPRODUCED, DISTRIBUTED
OR USED AS A BASIS FOR MANUFACTURE
WITHOUT PRIOR WRITTEN PERMISSION
FROM KEYSTONE ELECTRONICS CORP.

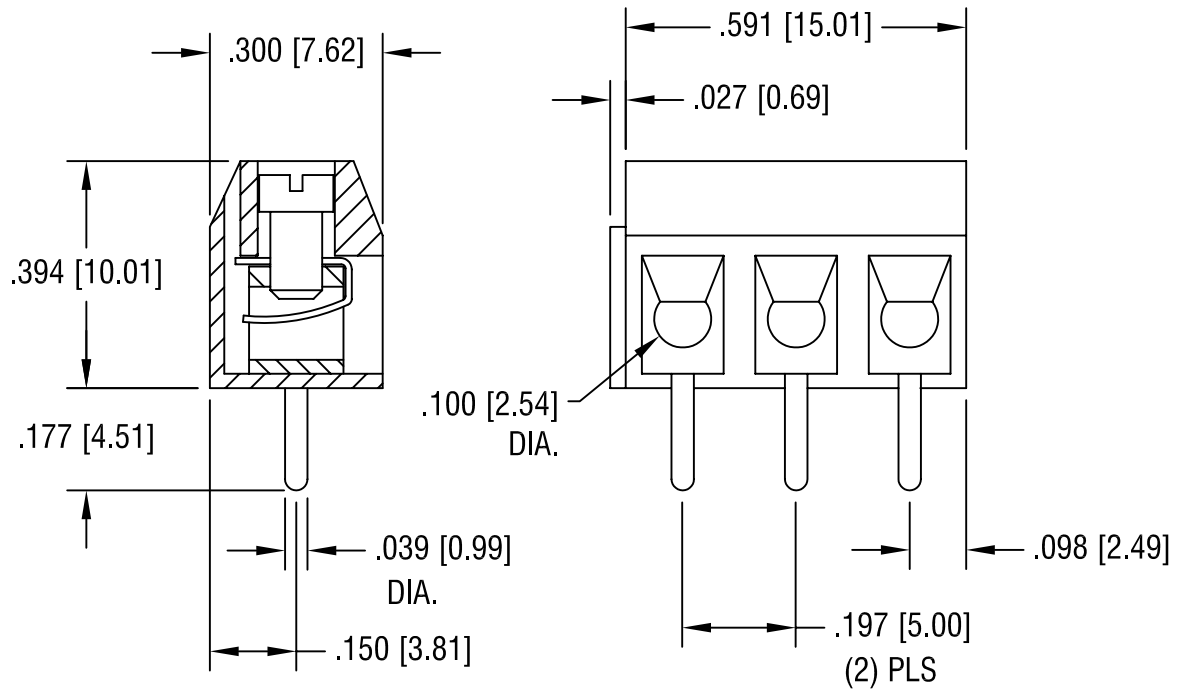

NOTES:

- MAT'L:
HOUSING: BLUE PBT, UL 94V-0
CONTACT: BRASS, TIN PLATE
SCREW, CAPTIVATED: STEEL, ZINC PLATE
- RECOMMENDED MOUNTING HOLE:
.047 [1.19] DIA. (3) PLS

KEYSTONE ELECTRONICS CORP.			
ASTORIA, N.Y. 11105-2017			
PART NAME		5mm PC TERMINAL BLOCK	
MATERIAL		AS NOTED	
FINISH		DRN BY	DATE
AS NOTED		BOONE	7.23.98
		APP'D	SCALE
			3X
TOLERANCES	INCH [MM]	CODE	DWG NO.
DECIMAL	± .005 [± 0.15]	C/M	8719
ANGULAR	± 1°		
UNLESS OTHERWISE SPECIFIED			

DATE	DESCRIPTION	REV.