

## Data sheet | Item number: 2202-1761

3-conductor carrier terminal block; with push-button; for DIN-rail 35 x 15 and 35 x 7.5; 2.5 mm<sup>2</sup>; Push-in CAGE CLAMP®; 2,50 mm<sup>2</sup>; gray

[www.wago.com/2202-1761](http://www.wago.com/2202-1761)

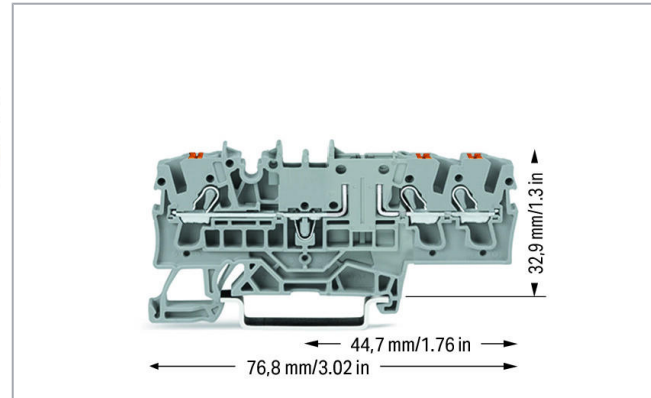
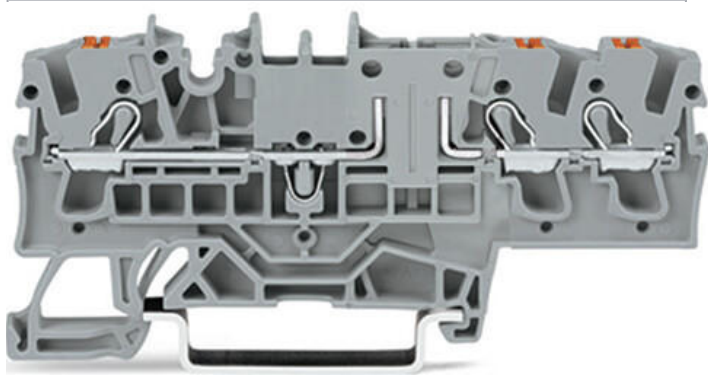

RoHS  Compliant

[BOMcheck.net](https://www.bomcheck.net)

Color: ■

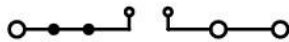

### Data

#### Electrical data

#### Ratings per IEC/EN

Ratings per	IEC/EN 60947-7-1
Nominal voltage (III/3)	400 V
Rated surge voltage (III/3)	6 kV
Rated current	16 A

Subject to changes. Please also observe the further product documentation!

WAGO Kontakttechnik GmbH & Co. KG  
Hansastr. 27  
32423 Minden  
Phone: +49571 887-0 | Fax: +49571 887-169  
Email: [info.de@wago.com](mailto:info.de@wago.com) | Web: [www.wago.com](http://www.wago.com)

Do you have any questions about our products?  
We are always happy to take your call at 01788 568 008.



Legend (ratings)

(III / 3) ≙ Overvoltage category III / Pollution degree 3

### Ratings per UL

Approvals per	UL 1059
Rated voltage UL (Use Group B)	300 V
Rated current UL (Use Group B)	15 A
Rated voltage UL (Use Group C)	300 V
Rated current UL (Use Group C)	15 A

### Ratings per CSA

Approvals per	C22.2 No 158
Rated voltage CSA (Use Group B)	300 V
Rated current CSA (Use Group B)	15 A
Rated voltage CSA (Use Group C)	300 V
Rated current CSA (Use Group C)	15 A

### Connection data

Connection technology	Push-in CAGE CLAMP®
Actuation type	Push-in Push-button Operating tool
Connectable conductor materials	Copper
Nominal cross-section	2.5 mm <sup>2</sup>
Solid conductor	0.25 ... 4 mm <sup>2</sup> / 22 ... 12 AWG
Solid conductor; push-in termination	0.75 ... 4 mm <sup>2</sup> / 18 ... 12 AWG
Fine-stranded conductor	0.25 ... 4 mm <sup>2</sup> / 22 ... 12 AWG
Fine-stranded conductor; with insulated ferrule	1 ... 2.5 mm <sup>2</sup> / 18 ... 14 AWG
Fine-stranded conductor; with ferrule; push-in termination	1 ... 2.5 mm <sup>2</sup> / 18 ... 14 AWG
Note (conductor cross-section)	Depending on the conductor characteristic, a conductor with a smaller cross-section can also be inserted via push-in termination.
Strip length	10 ... 12 mm / 0.39 ... 0.47 inch
Total number of connection points	3
Total number of potentials	2
Number of levels	1
Wiring type	Front-entry wiring
Number of jumper slots	2

Subject to changes. Please also observe the further product documentation!

WAGO Kontakttechnik GmbH & Co. KG  
 Hansastr. 27  
 32423 Minden  
 Phone: +49571 887-0 | Fax: +49571 887-169  
 Email: [info.de@wago.com](mailto:info.de@wago.com) | Web: [www.wago.com](http://www.wago.com)

Do you have any questions about our products?  
 We are always happy to take your call at 01788 568 008.

## Physical data

Width	5.2 mm / 0.205 inch
Height	76.8 mm / 3.024 inch

## Mechanical data

Design	horizontal type
Mounting type	DIN-35 rail
Marking level	Center/side marking

## Material data



Color	gray
Insulation material	Polyamide (PA66)
Weight	8.4 g

## Commercial data

Packaging type	BOX
Country of origin	DE
GTIN	4055143961134
Customs tariff number	85369010000

## Approvals / Certificates

### Ex-Approvals

Logo	Approval	Additional Approval Text	Certificate name
	AEx Underwriters Laboratories Inc.	UL 60079	E185892
	CCCEx CQST/CNEX	CNCA-C23-01	2020312313000288



### UL-Approvals

Logo	Approval	Additional Approval Text	Certificate name
	UL Underwriters Laboratories Inc.	UL 1059	E45172

Subject to changes. Please also observe the further product documentation!





## Required accessories

### End plate





	<b>Item no.: 2002-1791</b> End and intermediate plate; 1 mm thick; gray	<a href="http://www.wago.com/2002-1791">www.wago.com/2002-1791</a>
	<b>Item no.: 2002-1792</b> End and intermediate plate; 1 mm thick; orange	<a href="http://www.wago.com/2002-1792">www.wago.com/2002-1792</a>

## Compatible products















### Push-In type wire jumper

	<b>Item no.: 2009-412</b> Push-in type wire jumper; insulated; 60 mm long; black	<a href="http://www.wago.com/2009-412">www.wago.com/2009-412</a>
	<b>Item no.: 2009-414</b> Push-in type wire jumper; 1.5 mm <sup>2</sup> ; insulated; 110 mm long; black	<a href="http://www.wago.com/2009-414">www.wago.com/2009-414</a>
	<b>Item no.: 2009-414/000-005</b> Push-in type wire jumper; 1.5 mm <sup>2</sup> ; insulated; 110 mm long; black	<a href="http://www.wago.com/2009-414/000-005">www.wago.com/2009-414/000-005</a>
	<b>Item no.: 2009-414/000-006</b> Push-in type wire jumper; insulated; 110 mm long; black	<a href="http://www.wago.com/2009-414/000-006">www.wago.com/2009-414/000-006</a>
	<b>Item no.: 2009-416</b> Push-in type wire jumper; 1.5 mm <sup>2</sup> ; insulated; 250 mm long; black	<a href="http://www.wago.com/2009-416">www.wago.com/2009-416</a>















### ferrule

	<b>Item no.: 216-241</b> Ferrule; Sleeve for 0.5 mm <sup>2</sup> / 20 AWG; insulated; electro-tin plated; electrolytic copper; gastight crimped; acc. to DIN 46228, Part 4/09.90; white	<a href="http://www.wago.com/216-241">www.wago.com/216-241</a>
	<b>Item no.: 216-242</b> Ferrule; Sleeve for 0.75 mm <sup>2</sup> / 18 AWG; insulated; electro-tin plated; electrolytic copper; gastight crimped; acc. to DIN 46228, Part 4/09.90; gray	<a href="http://www.wago.com/216-242">www.wago.com/216-242</a>
	<b>Item no.: 216-243</b> Ferrule; Sleeve for 1 mm <sup>2</sup> / AWG 18; insulated; electro-tin plated; electrolytic copper; gastight crimped; acc. to DIN 46228, Part 4/09.90; red	<a href="http://www.wago.com/216-243">www.wago.com/216-243</a>
	<b>Item no.: 216-244</b> Ferrule; Sleeve for 1.5 mm <sup>2</sup> / AWG 16; insulated; electro-tin plated; electrolytic copper; gastight crimped; acc. to DIN 46228, Part 4/09.90; black	<a href="http://www.wago.com/216-244">www.wago.com/216-244</a>
	<b>Item no.: 216-246</b> Ferrule; Sleeve for 2.5 mm <sup>2</sup> / AWG 14; insulated; electro-tin plated; electrolytic copper; gastight crimped; acc. to DIN 46228, Part 4/09.90; blue	<a href="http://www.wago.com/216-246">www.wago.com/216-246</a>
	<b>Item no.: 216-262</b> Ferrule; Sleeve for 0.75 mm <sup>2</sup> / 18 AWG; insulated; electro-tin plated; electrolytic copper; gastight	<a href="http://www.wago.com/216-262">www.wago.com/216-262</a>

















Subject to changes. Please also observe the further product documentation!

	crimped; acc. to DIN 46228, Part 4/09.90; gray	
	<b>Item no.: 216-263</b> Ferrule; Sleeve for 1 mm <sup>2</sup> / AWG 18; insulated; electro-tin plated; electrolytic copper; gastight crimped; acc. to DIN 46228, Part 4/09.90; red	<a href="http://www.wago.com/216-263">www.wago.com/216-263</a>
	<b>Item no.: 216-264</b> Ferrule; Sleeve for 1.5 mm <sup>2</sup> / AWG 16; insulated; electro-tin plated; electrolytic copper; gastight crimped; acc. to DIN 46228, Part 4/09.90; black	<a href="http://www.wago.com/216-264">www.wago.com/216-264</a>
	<b>Item no.: 216-266</b> Ferrule; Sleeve for 2.5 mm <sup>2</sup> / AWG 14; insulated; electro-tin plated; electrolytic copper; gastight crimped; acc. to DIN 46228, Part 4/09.90; blue	<a href="http://www.wago.com/216-266">www.wago.com/216-266</a>
<b>General accessories</b>		
	<b>Item no.: 2002-401</b> Disconnect plug for carrier terminal blocks; for using a receptacle terminal block as a disconnect terminal block; orange	<a href="http://www.wago.com/2002-401">www.wago.com/2002-401</a>
<b>Jumper</b>		
	<b>Item no.: 2002-400</b> Continuous jumper; 2-way; insulated; light gray	<a href="http://www.wago.com/2002-400">www.wago.com/2002-400</a>
	<b>Item no.: 2002-402</b> Jumper; 2-way; insulated; light gray	<a href="http://www.wago.com/2002-402">www.wago.com/2002-402</a>
	<b>Item no.: 2002-402/000-005</b> Jumper; 2-way; insulated; red	<a href="http://www.wago.com/2002-402/000-005">www.wago.com/2002-402/000-005</a>
	<b>Item no.: 2002-402/000-006</b> Jumper; 2-way; insulated; blue	<a href="http://www.wago.com/2002-402/000-006">www.wago.com/2002-402/000-006</a>
	<b>Item no.: 2002-403</b> Jumper; 3-way; insulated; light gray	<a href="http://www.wago.com/2002-403">www.wago.com/2002-403</a>
	<b>Item no.: 2002-403/000-005</b> Jumper; 3-way; insulated; red	<a href="http://www.wago.com/2002-403/000-005">www.wago.com/2002-403/000-005</a>
	<b>Item no.: 2002-403/000-006</b> Jumper; 3-way; insulated; blue	<a href="http://www.wago.com/2002-403/000-006">www.wago.com/2002-403/000-006</a>
	<b>Item no.: 2002-404</b> Jumper; 4-way; insulated; light gray	<a href="http://www.wago.com/2002-404">www.wago.com/2002-404</a>
	<b>Item no.: 2002-404/000-005</b> Jumper; 4-way; insulated; red	<a href="http://www.wago.com/2002-404/000-005">www.wago.com/2002-404/000-005</a>
	<b>Item no.: 2002-404/000-006</b> Jumper; 4-way; insulated; blue	<a href="http://www.wago.com/2002-404/000-006">www.wago.com/2002-404/000-006</a>







Subject to changes. Please also observe the further product documentation!

	<b>Item no.: 2002-405</b> Jumper; 5-way; insulated; light gray	<a href="http://www.wago.com/2002-405">www.wago.com/2002-405</a>
	<b>Item no.: 2002-405/000-005</b> Jumper; 5-way; insulated; red	<a href="http://www.wago.com/2002-405/000-005">www.wago.com/2002-405/000-005</a>
	<b>Item no.: 2002-405/000-006</b> Jumper; 5-way; insulated; blue	<a href="http://www.wago.com/2002-405/000-006">www.wago.com/2002-405/000-006</a>
	<b>Item no.: 2002-405/011-000</b> Star point jumper; 3-way; insulated; light gray	<a href="http://www.wago.com/2002-405/011-000">www.wago.com/2002-405/011-000</a>
	<b>Item no.: 2002-406</b> Jumper; 6-way; insulated; light gray	<a href="http://www.wago.com/2002-406">www.wago.com/2002-406</a>
	<b>Item no.: 2002-406/000-005</b> Jumper; 6-way; insulated; red	<a href="http://www.wago.com/2002-406/000-005">www.wago.com/2002-406/000-005</a>
	<b>Item no.: 2002-406/000-006</b> Jumper; 6-way; insulated; blue	<a href="http://www.wago.com/2002-406/000-006">www.wago.com/2002-406/000-006</a>
	<b>Item no.: 2002-406/020-000</b> Delta jumper; insulated; light gray	<a href="http://www.wago.com/2002-406/020-000">www.wago.com/2002-406/020-000</a>
	<b>Item no.: 2002-407</b> Jumper; 7-way; insulated; light gray	<a href="http://www.wago.com/2002-407">www.wago.com/2002-407</a>
	<b>Item no.: 2002-407/000-005</b> Jumper; 7-way; insulated; red	<a href="http://www.wago.com/2002-407/000-005">www.wago.com/2002-407/000-005</a>
	<b>Item no.: 2002-407/000-006</b> Jumper; 7-way; insulated; blue	<a href="http://www.wago.com/2002-407/000-006">www.wago.com/2002-407/000-006</a>
	<b>Item no.: 2002-408</b> Jumper; 8-way; insulated; light gray	<a href="http://www.wago.com/2002-408">www.wago.com/2002-408</a>
	<b>Item no.: 2002-408/000-005</b> Jumper; 8-way; insulated; red	<a href="http://www.wago.com/2002-408/000-005">www.wago.com/2002-408/000-005</a>
	<b>Item no.: 2002-408/000-006</b> Jumper; 8-way; insulated; blue	<a href="http://www.wago.com/2002-408/000-006">www.wago.com/2002-408/000-006</a>

Subject to changes. Please also observe the further product documentation!

	<b>Item no.: 2002-409</b> Jumper; 9-way; insulated; light gray	<a href="http://www.wago.com/2002-409">www.wago.com/2002-409</a>
	<b>Item no.: 2002-409/000-005</b> Jumper; 9-way; insulated; red	<a href="http://www.wago.com/2002-409/000-005">www.wago.com/2002-409/000-005</a>
	<b>Item no.: 2002-409/000-006</b> Jumper; 9-way; insulated; blue	<a href="http://www.wago.com/2002-409/000-006">www.wago.com/2002-409/000-006</a>
	<b>Item no.: 2002-410</b> Jumper; 10-way; insulated; light gray	<a href="http://www.wago.com/2002-410">www.wago.com/2002-410</a>
	<b>Item no.: 2002-410/000-005</b> Jumper; 10-way; insulated; red	<a href="http://www.wago.com/2002-410/000-005">www.wago.com/2002-410/000-005</a>
	<b>Item no.: 2002-410/000-006</b> Jumper; 10-way; insulated; blue	<a href="http://www.wago.com/2002-410/000-006">www.wago.com/2002-410/000-006</a>
	<b>Item no.: 2002-423</b> Continuous jumper; from 1 to 3; insulated; light gray	<a href="http://www.wago.com/2002-423">www.wago.com/2002-423</a>
	<b>Item no.: 2002-423/000-005</b> Continuous jumper; from 1 to 3; insulated; red	<a href="http://www.wago.com/2002-423/000-005">www.wago.com/2002-423/000-005</a>
	<b>Item no.: 2002-423/000-006</b> Continuous jumper; from 1 to 3; insulated; blue	<a href="http://www.wago.com/2002-423/000-006">www.wago.com/2002-423/000-006</a>
	<b>Item no.: 2002-433</b> Jumper; from 1 to 3; insulated; light gray	<a href="http://www.wago.com/2002-433">www.wago.com/2002-433</a>
	<b>Item no.: 2002-434</b> Jumper; from 1 to 4; insulated; light gray	<a href="http://www.wago.com/2002-434">www.wago.com/2002-434</a>
	<b>Item no.: 2002-435</b> Jumper; from 1 to 5; insulated; light gray	<a href="http://www.wago.com/2002-435">www.wago.com/2002-435</a>
	<b>Item no.: 2002-436</b> Jumper; from 1 to 6; insulated; light gray	<a href="http://www.wago.com/2002-436">www.wago.com/2002-436</a>
	<b>Item no.: 2002-437</b> Jumper; from 1 to 7; insulated; light gray	<a href="http://www.wago.com/2002-437">www.wago.com/2002-437</a>
	<b>Item no.: 2002-438</b> Jumper; from 1 to 8; insulated; light gray	<a href="http://www.wago.com/2002-438">www.wago.com/2002-438</a>
	<b>Item no.: 2002-439</b> Jumper; from 1 to 9; insulated; light gray	<a href="http://www.wago.com/2002-439">www.wago.com/2002-439</a>

Subject to changes. Please also observe the further product documentation!

	<b>Item no.: 2002-440</b> Jumper; from 1 to 10; insulated; light gray	<a href="http://www.wago.com/2002-440">www.wago.com/2002-440</a>
	<b>Item no.: 2002-472</b> Staggered jumper; 2-way; insulated; light gray	<a href="http://www.wago.com/2002-472">www.wago.com/2002-472</a>
	<b>Item no.: 2002-473</b> Staggered jumper; 3-way; insulated; light gray	<a href="http://www.wago.com/2002-473">www.wago.com/2002-473</a>
	<b>Item no.: 2002-473/011-000</b> Staggered jumper; 2-way; from 1 to 3; insulated; light gray	<a href="http://www.wago.com/2002-473/011-000">www.wago.com/2002-473/011-000</a>
	<b>Item no.: 2002-474</b> Staggered jumper; 4-way; insulated; light gray	<a href="http://www.wago.com/2002-474">www.wago.com/2002-474</a>
	<b>Item no.: 2002-475</b> Staggered jumper; 5-way; insulated; light gray	<a href="http://www.wago.com/2002-475">www.wago.com/2002-475</a>
	<b>Item no.: 2002-475/011-000</b> Staggered jumper; 3-way; insulated; light gray	<a href="http://www.wago.com/2002-475/011-000">www.wago.com/2002-475/011-000</a>
	<b>Item no.: 2002-476</b> Staggered jumper; 6-way; insulated; light gray	<a href="http://www.wago.com/2002-476">www.wago.com/2002-476</a>
	<b>Item no.: 2002-477</b> Staggered jumper; 7-way; insulated; light gray	<a href="http://www.wago.com/2002-477">www.wago.com/2002-477</a>
	<b>Item no.: 2002-477/011-000</b> Staggered jumper; insulated; light gray	<a href="http://www.wago.com/2002-477/011-000">www.wago.com/2002-477/011-000</a>
	<b>Item no.: 2002-478</b> Staggered jumper; 8-way; insulated; light gray	<a href="http://www.wago.com/2002-478">www.wago.com/2002-478</a>
	<b>Item no.: 2002-479</b> Staggered jumper; 9-way; insulated; light gray	<a href="http://www.wago.com/2002-479">www.wago.com/2002-479</a>
	<b>Item no.: 2002-479/011-000</b> Staggered jumper; insulated; light gray	<a href="http://www.wago.com/2002-479/011-000">www.wago.com/2002-479/011-000</a>
	<b>Item no.: 2002-480</b> Staggered jumper; 10-way; insulated; light gray	<a href="http://www.wago.com/2002-480">www.wago.com/2002-480</a>
	<b>Item no.: 2002-481</b> Staggered jumper; 11-way; insulated; light gray	<a href="http://www.wago.com/2002-481">www.wago.com/2002-481</a>
	<b>Item no.: 2002-481/011-000</b> Staggered jumper; insulated; light gray	<a href="http://www.wago.com/2002-481/011-000">www.wago.com/2002-481/011-000</a>
	<b>Item no.: 2002-482</b>	

Subject to changes. Please also observe the further product documentation!





Staggered jumper; 12-way; insulated; light gray

[www.wago.com/2002-482](http://www.wago.com/2002-482)



**Item no.: 210-103**

Wire commoning chain; insulated; black

[www.wago.com/210-103](http://www.wago.com/210-103)



**Item no.: 210-123**

Wire commoning chain; insulated; blue

[www.wago.com/210-123](http://www.wago.com/210-123)

**Carrier rail**



**Item no.: 210-112**

Steel carrier rail; 35 x 7.5 mm; 1 mm thick; 2 m long; slotted; according to EN 60715; "Hole width 25 mm; silver-colored



**Item no.: 210-113**

Steel carrier rail; 35 x 7.5 mm; 1 mm thick; 2 m long; unslotted; according to EN 60715; silver-colored

[www.wago.com/210-113](http://www.wago.com/210-113)



**Item no.: 210-114**

Steel carrier rail; 35 x 15 mm; 1.5 mm thick; 2 m long; unslotted; similar to EN 60715; silver-colored

[www.wago.com/210-114](http://www.wago.com/210-114)



**Item no.: 210-115**

Steel carrier rail; 35 x 7.5 mm; 1 mm thick; 2 m long; slotted; according to EN 60715; "Hole width 18 mm; silver-colored



**Item no.: 210-118**

Steel carrier rail; 35 x 15 mm; 2.3 mm thick; 2 m long; unslotted; according to EN 60715; silver-colored

[www.wago.com/210-118](http://www.wago.com/210-118)



**Item no.: 210-196**

Aluminum carrier rail; 35 x 8.2 mm; 1.6 mm thick; 2 m long; unslotted; similar to EN 60715; silver-colored

[www.wago.com/210-196](http://www.wago.com/210-196)



**Item no.: 210-197**

Steel carrier rail; 35 x 15 mm; 1.5 mm thick; 2 m long; slotted; similar to EN 60715; silver-colored

[www.wago.com/210-197](http://www.wago.com/210-197)



**Item no.: 210-198**

Copper carrier rail; 35 x 15 mm; 2.3 mm thick; 2 m long; unslotted; according to EN 60715; copper-colored

[www.wago.com/210-198](http://www.wago.com/210-198)



**Item no.: 210-504**

Steel carrier rail; 35 x 7.5 mm; 1 mm thick; 2 m long; slotted; galvanized; according to EN 60715; silver-colored

[www.wago.com/210-504](http://www.wago.com/210-504)



**Item no.: 210-505**

Steel carrier rail; 35 x 7.5 mm; 1 mm thick; 2 m long; unslotted; galvanized; according to EN 60715; silver-colored

[www.wago.com/210-505](http://www.wago.com/210-505)



**Item no.: 210-506**

Steel carrier rail; 35 x 15 mm; 1.5 mm thick; 2 m long; unslotted; galvanized; similar to EN 60715; silver-colored

[www.wago.com/210-506](http://www.wago.com/210-506)



**Item no.: 210-508**

Steel carrier rail; 35 x 15 mm; 1.5 mm thick; 2 m long; slotted; galvanized; similar to EN 60715; silver-colored

[www.wago.com/210-508](http://www.wago.com/210-508)

**check**



**Item no.: 210-136**

Test plug; 2 mm Ø; with 500 mm cable; red

[www.wago.com/210-136](http://www.wago.com/210-136)

**plug**

Subject to changes. Please also observe the further product documentation!

WAGO Kontakttechnik GmbH & Co. KG

Hansastr. 27











32423 Minden

Phone: +49571 887-0 | Fax: +49571 887-169

Email: [info.de@wago.com](mailto:info.de@wago.com) | Web: [www.wago.com](http://www.wago.com)

Do you have any questions about our products?

We are always happy to take your call at 01788 568 008.

	<b>Item no.: 2002-800</b> Empty component plug housing; 5.2 mm wide; 2-pole; Type 1; gray	<a href="http://www.wago.com/2002-800">www.wago.com/2002-800</a>
	<b>Item no.: 2002-800/1000-410</b> Component plug; for carrier terminal blocks; 2-pole; with diode 1N4007; anode, left side; 5.2 mm wide; Operating temperature 85°C max.; gray	<a href="http://www.wago.com/2002-800/1000-410">www.wago.com/2002-800/1000-410</a>
	<b>Item no.: 2002-800/1000-411</b> Component plug; for carrier terminal blocks; 2-pole; with diode 1N4007; 5.2 mm wide; Operating temperature 85°C max.; gray	<a href="http://www.wago.com/2002-800/1000-411">www.wago.com/2002-800/1000-411</a>
	<b>Item no.: 2002-800/1000-541</b> Component plug; for carrier terminal blocks; 1-pole; LED (red); 5.2 mm wide; Operating temperature 85°C max.; gray	<a href="http://www.wago.com/2002-800/1000-541">www.wago.com/2002-800/1000-541</a>
	<b>Item no.: 2002-800/1000-542</b> Component plug; for carrier terminal blocks; 1-pole; LED (red); 5.2 mm wide; Operating temperature 85°C max.; gray	<a href="http://www.wago.com/2002-800/1000-542">www.wago.com/2002-800/1000-542</a>
	<b>Item no.: 2002-800/1000-836</b> Component plug; for carrier terminal blocks; 1-pole; LED (red); 5.2 mm wide; Operating temperature 85°C max.; gray	<a href="http://www.wago.com/2002-800/1000-836">www.wago.com/2002-800/1000-836</a>
	<b>Item no.: 2002-810</b> Empty component plug housing; 10.4 mm wide; 2-pole; Type 2; gray	<a href="http://www.wago.com/2002-810">www.wago.com/2002-810</a>
	<b>Item no.: 2002-820</b> Empty component plug housing; 10.4 mm wide; 4-pole; Type 3; gray	<a href="http://www.wago.com/2002-820">www.wago.com/2002-820</a>
	<b>Item no.: 2003-911</b> Double fuse plug; for 5 x 20 mm miniature metric fuse; without blown fuse indication; 10.4 mm wide; gray	<a href="http://www.wago.com/2003-911">www.wago.com/2003-911</a>
	<b>Item no.: 2003-911/1000-923</b> Double fuse plug; for 5 x 20 mm miniature metric fuse; with indicator lamp; 230 V; 10.4 mm wide; gray	<a href="http://www.wago.com/2003-911/1000-923">www.wago.com/2003-911/1000-923</a>
	<b>Item no.: 2004-911</b> Fuse plug; with pull-tab; for miniature metric fuses 5 x 20 mm and 5 x 25 mm; without blown fuse indication; 6.1 mm wide; gray	<a href="http://www.wago.com/2004-911">www.wago.com/2004-911</a>
	<b>Item no.: 2004-911/1000-541</b> Fuse plug; with pull-tab; for 5 x 20 mm miniature metric fuse; with indicator lamp; 12 - 30 V; 6.1 mm wide; gray	<a href="http://www.wago.com/2004-911/1000-541">www.wago.com/2004-911/1000-541</a>
	<b>Item no.: 2004-911/1000-542</b> Fuse plug; with pull-tab; for 5 x 20 mm miniature metric fuse; with indicator lamp; 30 - 65 V; 6.1 mm wide; gray	<a href="http://www.wago.com/2004-911/1000-542">www.wago.com/2004-911/1000-542</a>
	<b>Item no.: 2004-911/1000-836</b> Fuse plug; with pull-tab; for 5 x 20 mm miniature metric fuse; with indicator lamp; 230 V; 6.1 mm wide; gray	<a href="http://www.wago.com/2004-911/1000-836">www.wago.com/2004-911/1000-836</a>













**Item no.: 2004-911/1000-867**

Subject to changes. Please also observe the further product documentation!

 Fuse plug; with pull-tab; for 5 x 20 mm miniature metric fuse; with indicator lamp; 120 V; 6.1 mm wide; gray

[www.wago.com/2004-911/1000-867](http://www.wago.com/2004-911/1000-867)

**Marking accessories**

	<b>Item no.: 2002-121</b> Adaptor; gray	<a href="http://www.wago.com/2002-121">www.wago.com/2002-121</a>
	<b>Item no.: 2002-161</b> Adaptor; gray	<a href="http://www.wago.com/2002-161">www.wago.com/2002-161</a>
	<b>Item no.: 2009-110</b> Marking strips; for Smart Printer; on reel; not stretchable; plain; snap-on type; white	<a href="http://www.wago.com/2009-110">www.wago.com/2009-110</a>
	<b>Item no.: 2009-115</b> WMB-Inline; for Smart Printer; 1500 pieces on roll; stretchable 5 - 5.2 mm; plain; snap-on type; white	<a href="http://www.wago.com/2009-115">www.wago.com/2009-115</a>
	<b>Item no.: 2009-115/000-002</b> WMB-Inline; for Smart Printer; 1500 pieces on roll; stretchable 5 - 5.2 mm; plain; snap-on type; yellow	<a href="http://www.wago.com/2009-115/000-002">www.wago.com/2009-115/000-002</a>
	<b>Item no.: 2009-115/000-005</b> WMB-Inline; for Smart Printer; 1500 pieces on roll; stretchable 5 - 5.2 mm; plain; snap-on type; red	<a href="http://www.wago.com/2009-115/000-005">www.wago.com/2009-115/000-005</a>
	<b>Item no.: 2009-115/000-006</b> WMB-Inline; for Smart Printer; 1500 pieces on roll; stretchable 5 - 5.2 mm; plain; snap-on type; blue	<a href="http://www.wago.com/2009-115/000-006">www.wago.com/2009-115/000-006</a>
	<b>Item no.: 2009-115/000-007</b> WMB-Inline; for Smart Printer; 1500 pieces on roll; stretchable 5 - 5.2 mm; plain; snap-on type; gray	<a href="http://www.wago.com/2009-115/000-007">www.wago.com/2009-115/000-007</a>
	<b>Item no.: 2009-115/000-012</b> WMB-Inline; for Smart Printer; 1500 pieces on roll; stretchable 5 - 5.2 mm; plain; snap-on type; orange	<a href="http://www.wago.com/2009-115/000-012">www.wago.com/2009-115/000-012</a>
	<b>Item no.: 2009-115/000-017</b> WMB-Inline; for Smart Printer; 1500 pieces on roll; stretchable 5 - 5.2 mm; plain; snap-on type; light green	<a href="http://www.wago.com/2009-115/000-017">www.wago.com/2009-115/000-017</a>
	<b>Item no.: 2009-115/000-023</b> WMB-Inline; for Smart Printer; 1500 pieces on roll; stretchable 5 - 5.2 mm; plain; snap-on type; green	<a href="http://www.wago.com/2009-115/000-023">www.wago.com/2009-115/000-023</a>
	<b>Item no.: 2009-115/000-024</b> WMB-Inline; for Smart Printer; 1500 pieces on roll; stretchable 5 - 5.2 mm; plain; snap-on type; violet	<a href="http://www.wago.com/2009-115/000-024">www.wago.com/2009-115/000-024</a>
	<b>Item no.: 2009-145</b> Mini-WSB Inline; for Smart Printer; 1700 pieces on roll; stretchable 5 - 5.2 mm; plain; snap-on type; white	<a href="http://www.wago.com/2009-145">www.wago.com/2009-145</a>

**Item no.: 2009-145/000-002**

Subject to changes. Please also observe the further product documentation!

 Mini-WSB Inline; for Smart Printer; 1700 pieces on roll; stretchable 5 - 5.2 mm; plain; snap-on type; yellow [www.wago.com/2009-145/000-002](http://www.wago.com/2009-145/000-002)

 **Item no.: 2009-145/000-005**  
Mini-WSB Inline; for Smart Printer; 1700 pieces on roll; stretchable 5 - 5.2 mm; plain; snap-on type; red [www.wago.com/2009-145/000-005](http://www.wago.com/2009-145/000-005)

 **Item no.: 2009-145/000-006**  
Mini-WSB Inline; for Smart Printer; 1700 pieces on roll; stretchable 5 - 5.2 mm; plain; snap-on type; blue [www.wago.com/2009-145/000-006](http://www.wago.com/2009-145/000-006)

 **Item no.: 2009-145/000-007**  
Mini-WSB Inline; for Smart Printer; 1700 pieces on roll; stretchable 5 - 5.2 mm; plain; snap-on type; gray [www.wago.com/2009-145/000-007](http://www.wago.com/2009-145/000-007)

 **Item no.: 2009-145/000-012**  
Mini-WSB Inline; for Smart Printer; 1700 pieces on roll; stretchable 5 - 5.2 mm; plain; snap-on type; orange [www.wago.com/2009-145/000-012](http://www.wago.com/2009-145/000-012)

 **Item no.: 2009-145/000-023**  
Mini-WSB Inline; for Smart Printer; 1700 pieces on roll; stretchable 5 - 5.2 mm; plain; snap-on type; green [www.wago.com/2009-145/000-023](http://www.wago.com/2009-145/000-023)

 **Item no.: 2009-145/000-024**  
Mini-WSB Inline; for Smart Printer; 1700 pieces on roll; stretchable 5 - 5.2 mm; plain; snap-on type; violet [www.wago.com/2009-145/000-024](http://www.wago.com/2009-145/000-024)

 **Item no.: 248-501**  
Miniature WSB Quick marking system; plain; Marker width 5 mm; 10 strips with 10 markers per card [www.wago.com/248-501](http://www.wago.com/248-501)

 **Item no.: 248-501/000-002**  
Mini-WSB marking card; as card; not stretchable; plain; snap-on type; yellow [www.wago.com/248-501/000-002](http://www.wago.com/248-501/000-002)

 **Item no.: 248-501/000-005**  
Mini-WSB marking card; as card; not stretchable; plain; snap-on type; red [www.wago.com/248-501/000-005](http://www.wago.com/248-501/000-005)

 **Item no.: 248-501/000-006**  
Mini-WSB marking card; as card; not stretchable; plain; snap-on type; blue [www.wago.com/248-501/000-006](http://www.wago.com/248-501/000-006)

 **Item no.: 248-501/000-007**  
Mini-WSB marking card; as card; not stretchable; plain; snap-on type; gray [www.wago.com/248-501/000-007](http://www.wago.com/248-501/000-007)

 **Item no.: 248-501/000-012**  
Mini-WSB marking card; as card; not stretchable; plain; snap-on type; orange [www.wago.com/248-501/000-012](http://www.wago.com/248-501/000-012)

Subject to changes. Please also observe the further product documentation!



**Item no.: 248-501/000-017**  
Mini-WSB marking card; as card; not stretchable; plain; snap-on type; light green

[www.wago.com/248-501/000-017](http://www.wago.com/248-501/000-017)



**Item no.: 248-501/000-023**  
Mini-WSB marking card; as card; not stretchable; plain; snap-on type; green

[www.wago.com/248-501/000-023](http://www.wago.com/248-501/000-023)



**Item no.: 248-501/000-024**  
Mini-WSB marking card; as card; not stretchable; plain; snap-on type; violet

[www.wago.com/248-501/000-024](http://www.wago.com/248-501/000-024)



**Item no.: 793-501**  
WMB marking card; as card; not stretchable; plain; snap-on type; white

[www.wago.com/793-501](http://www.wago.com/793-501)



**Item no.: 793-501/000-002**  
WMB marking card; as card; not stretchable; plain; snap-on type; yellow

[www.wago.com/793-501/000-002](http://www.wago.com/793-501/000-002)



**Item no.: 793-501/000-005**  
WMB marking card; as card; not stretchable; plain; snap-on type; red

[www.wago.com/793-501/000-005](http://www.wago.com/793-501/000-005)



**Item no.: 793-501/000-006**  
WMB marking card; as card; not stretchable; plain; snap-on type; blue

[www.wago.com/793-501/000-006](http://www.wago.com/793-501/000-006)



**Item no.: 793-501/000-007**  
WMB marking card; as card; not stretchable; plain; snap-on type; gray

[www.wago.com/793-501/000-007](http://www.wago.com/793-501/000-007)



**Item no.: 793-501/000-012**  
WMB marking card; as card; not stretchable; plain; snap-on type; orange

[www.wago.com/793-501/000-012](http://www.wago.com/793-501/000-012)



**Item no.: 793-501/000-017**  
WMB marking card; as card; not stretchable; plain; snap-on type; light green

[www.wago.com/793-501/000-017](http://www.wago.com/793-501/000-017)



**Item no.: 793-501/000-023**  
WMB marking card; as card; not stretchable; plain; snap-on type; green

[www.wago.com/793-501/000-023](http://www.wago.com/793-501/000-023)



**Item no.: 793-501/000-024**  
WMB marking card; as card; not stretchable; plain; snap-on type; violet

[www.wago.com/793-501/000-024](http://www.wago.com/793-501/000-024)



**Item no.: 793-5501**  
WMB marking card; as card; for terminal block width 5 - 17.5 mm; stretchable 5 - 5.2 mm; plain; snap-on type; white













[www.wago.com/793-5501](http://www.wago.com/793-5501)



**Item no.: 793-5501/000-002**  
WMB marking card; as card; for terminal block width 5 - 17.5 mm; stretchable 5 - 5.2 mm; plain; snap-on type; yellow

[www.wago.com/793-5501/000-002](http://www.wago.com/793-5501/000-002)

Subject to changes. Please also observe the further product documentation!

	<b>Item no.: 793-5501/000-005</b> WMB marking card; as card; for terminal block width 5 - 17.5 mm; stretchable 5 - 5.2 mm; plain; snap-on type; red	<a href="http://www.wago.com/793-5501/000-005">www.wago.com/793-5501/000-005</a>
	<b>Item no.: 793-5501/000-006</b> WMB marking card; as card; for terminal block width 5 - 17.5 mm; stretchable 5 - 5.2 mm; plain; snap-on type; blue	<a href="http://www.wago.com/793-5501/000-006">www.wago.com/793-5501/000-006</a>
	<b>Item no.: 793-5501/000-007</b> WMB marking card; as card; for terminal block width 5 - 17.5 mm; stretchable 5 - 5.2 mm; plain; snap-on type; gray	<a href="http://www.wago.com/793-5501/000-007">www.wago.com/793-5501/000-007</a>
	<b>Item no.: 793-5501/000-012</b> WMB marking card; as card; for terminal block width 5 - 17.5 mm; stretchable 5 - 5.2 mm; plain; snap-on type; orange	<a href="http://www.wago.com/793-5501/000-012">www.wago.com/793-5501/000-012</a>
	<b>Item no.: 793-5501/000-014</b> WMB marking card; as card; for terminal block width 5 - 17.5 mm; stretchable 5 - 5.2 mm; plain; snap-on type; brown	<a href="http://www.wago.com/793-5501/000-014">www.wago.com/793-5501/000-014</a>
	<b>Item no.: 793-5501/000-017</b> WMB marking card; as card; for terminal block width 5 - 17.5 mm; stretchable 5 - 5.2 mm; plain; snap-on type; green	<a href="http://www.wago.com/793-5501/000-017">www.wago.com/793-5501/000-017</a>
	<b>Item no.: 793-5501/000-023</b> WMB marking card; as card; for terminal block width 5 - 17.5 mm; stretchable 5 - 5.2 mm; plain; snap-on type; light green	<a href="http://www.wago.com/793-5501/000-023">www.wago.com/793-5501/000-023</a>
	<b>Item no.: 793-5501/000-024</b> WMB marking card; as card; for terminal block width 5 - 17.5 mm; stretchable 5 - 5.2 mm; plain; snap-on type; violet	<a href="http://www.wago.com/793-5501/000-024">www.wago.com/793-5501/000-024</a>
<b>tools</b>		
	<b>Item no.: 210-658</b> Operating tool; Blade: 3.5 x 0.5 mm; with a partially insulated shaft; angled; short; multicoloured	<a href="http://www.wago.com/210-658">www.wago.com/210-658</a>
	<b>Item no.: 210-720</b> Operating tool; Blade: 3.5 x 0.5 mm; with a partially insulated shaft; multicoloured	<a href="http://www.wago.com/210-720">www.wago.com/210-720</a>
<b>Insulation stop</b>		
	<b>Item no.: 2002-171</b> Insulation stop; 0.25 - 0.5 mm <sup>2</sup> ; 5 pieces/strip; light gray	<a href="http://www.wago.com/2002-171">www.wago.com/2002-171</a>
	<b>Item no.: 2002-172</b> Insulation stop; 0.75 - 1 mm <sup>2</sup> ; 5 pieces/strip; dark gray	<a href="http://www.wago.com/2002-172">www.wago.com/2002-172</a>

## Downloads

### Documentation

### Additional Information

Subject to changes. Please also observe the further product documentation!

WAGO Kontakttechnik GmbH & Co. KG  
Hansastr. 27  
32423 Minden  
Phone: +49571 887-0 | Fax: +49571 887-169  
Email: [info.de@wago.com](mailto:info.de@wago.com) | Web: [www.wago.com](http://www.wago.com)

Do you have any questions about our products?  
We are always happy to take your call at 01788 568 008.

## Installation Notes

### Conductor termination

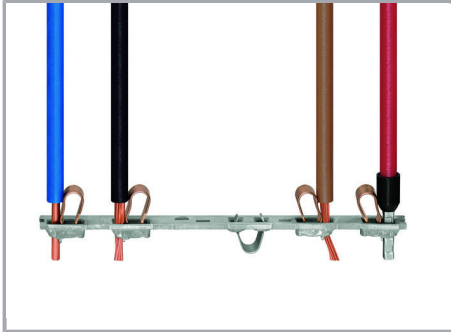

All conductor types at a glance

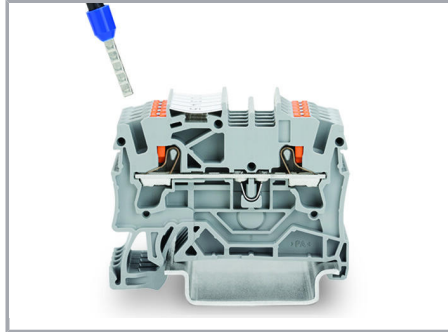

Push-in termination of solid and ferruled conductors

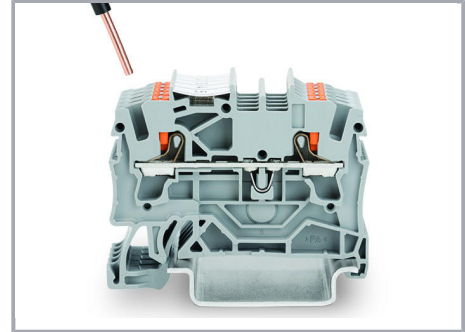

Push-in termination of solid and ferruled conductors



Insert fine-stranded conductors via operating tool.



Removing all conductors via operating tool.

### Commoning

Subject to changes. Please also observe the further product documentation!

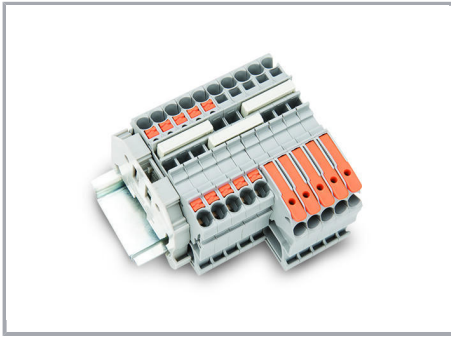

Insert a push-in type jumper bar and push down until it hits the backstop.

### Marking

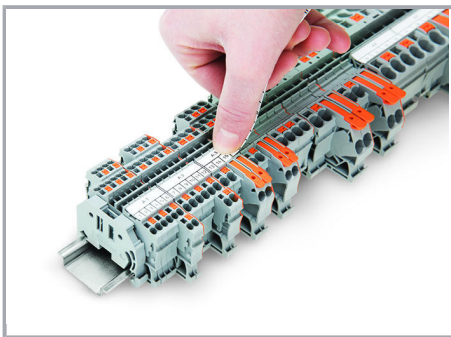

Snapping a marking strip into a marker slot.

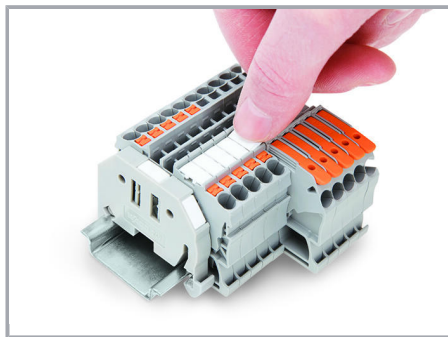

Snapping a marking strip into the marker slot.

### Product family

#### TOPJOB® S

TOPJOB® S: In various industrial applications and modern building installations, WAGO's wide and versatile range of rail-mount terminal blocks provides more than just reliable electrical connections.

[Show all products from the family](#)

Subject to changes. Please also observe the further product documentation!