

## 2J6975BGF

5GNR, Iridium and GNSS Screw Mount

### Key Features

#### Cable 1: 5GNR

- 617-960 MHz
- 1427-2690 MHz
- 3300-5000 MHz
- 5150-5925 MHz

#### Cable 2: Iridium

- 1616-1627 MHz

#### Cable 3: GPS/GLONASS/QZSS/Galileo

- 1575-1606 MHz

Screw Mount

#### Iridium Certified

Anti-Rotation Mounting

Ground Plane Independent

Customizable Cable and Connector

Dimensions 80 × 74 × 25.6 mm

Certificates: IP67, IP69



## 1. Antenna and electrical specifications

Cable 1

Parameters	5G NR Antenna			
Technologies	5G, 4G, 3G and 2G			
Standards	5G NR/4GLTE/FirstNet/CBRS/LPWA/CAT-X/CAT-Mx/CAT-NBx/NB-IoT/3G/2G			
Frequency (MHz)	617-960	1427-2690	3300-5000	5150-5925
Band (MHz)	600, 700, 850, 900	1500, 1600, 1700, 1800, 1900, 2000, 2100, 2300, 2500, 2600	3300, 3500, 3600, 3700, 4500	5200, 5500, 5800
5G NR Bands	n5, n8, 12, n20, n28, n71, n81, n82, n83,	n1, n2, n3, n7, n25, n34, n38, n39, n40, n41, n50, n51, n66, n70, n74, n75, n76, n80, n84, n86	n77, n78, n79	
4GLTE Bands	B5, B6, B8, B12, B13, B14, B17, B18, B19, B20, B26, B27, B28, B29, B44, B67, B68, B71, B85	B1, B2, B3, B4, B7, B9, B10, B11, B21, B23, B24, B25, B30, B32, B33, B34, B35, B36, B37, B38, B39, B40, B41, B45, B50, B51, B65, B66, B69, B70, B74, B75, B76	B22, B42, B43, B48, B49, B52	B46, B47, B252, B255
3GCELL Bands	B5, B6, B8, B12, B13, B14, B19, B20, B26	B1, B2, B3, B4, B7, B9, B10, B11, B21, B25, B32, B33, B34, B35, B36, B37, B38, B39, B40	B22	
2GCELL Bands	710, 750, 810T, 850, 900P, 900E, 900R	1800DCS, 1900PCS		
CDMA CELL Bands	BC0, BC2, BC3, BC7, BC9, BC10, BC12, BC18, BC19	BC1, BC4, BC6, BC8, BC13, BC14, BC15, BC16, BC20, BC21		
Return Loss (dB)	~-8.9	~-9.2	~-8.2	~-7.5
VSWR	~2.6:1	~2.4:1	~2.7:1	~2.5:1
Efficiency (%)	~55.0	~51.2	~25.7	~28.3
Peak Gain (dBi)	~2.3	~5.1	~2.6	~2.7
Average Gain (dB)	~-2.7	~-3.1	~-6.0	~-5.5
Impedance (Ohm)	50			
Polarisation	Linear			
Radiation Pattern	Omni-Directional			
Max. Input Power (W)	25			
Connector Type	SMA-Male Standard (Other Connectors Available)			
Cable Length	300 cm Standard (Any Cable Length Available)			
Cable Type	D302 Standard (Other Cables Available)			

### Antenna Measurement Conditions:

Mounted on 30 x 30 cm Metal Plate

100 cm of D302 Cable

Measured in Certified CTIA 3D Anechoic Chamber

Cable 2

Parameters	Iridium Antenna
<b>Standards</b>	Iridium
<b>Band (MHz)</b>	1621
<b>Frequency (MHz)</b>	1616-1627
<b>Return Loss (dB)</b>	~-12.5
<b>VSWR</b>	~1.6:1
<b>Efficiency (%)</b>	~68.1
<b>Peak Gain (dBic)</b>	~5.2
<b>Average Gain (dB)</b>	~-1.8
<b>Radiation Pattern</b>	Hemispherical
<b>Polarization</b>	RHCP
<b>Connector Type</b>	SMA-Male Standard (Other Connectors Available)
<b>Cable Length</b>	300 cm Standard (Any Cable Length Available)
<b>Cable Type</b>	D302 Standard (Other Cables Available)

Cable 3

Parameters	GNSS Ceramic Active Antenna	
<b>Standards</b>	GPS/QZSS/Galileo	GLONASS
<b>Band (MHz)</b>	1575	1602
<b>Frequency (Mhz)</b>	1575.42	1598-1606
<b>Patch Size (mm)</b>	25 x 25 x 4	
<b>Return Loss (dB)</b>	<=-15.0 dB	
<b>VSWR</b>	<=1.4:1 dB	
<b>Impedance (Ohms)</b>	50	
<b>Radiation Pattern</b>	Hemispherical	
<b>Polarization</b>	RHCP	
<b>Saw Filter Type</b>	Pre-filter	
<b>Active Gain (dB)</b>	28 @ 2.7 V	
<b>Noise Figure (dB)</b>	1.5 Typ	
<b>Voltage (V)</b>	1.5 – 3.6	
<b>Current Consumption (mA)</b>	9 Typ	
<b>Power Consumption (mW)</b>	24.3 Typ	
<b>ESD Protection (kV)</b>	2kV	
<b>Connector Type</b>	SMA-Male Standard (Other Connectors Available)	
<b>Cable Length</b>	300 cm Standard (Any Cable Length Available)	
<b>Cable Type</b>	D100 Standard (Other Cables Available)	

## 2. Mechanical and environmental specifications

Specifications	2J6975BGF
<b>Mounting Type</b>	Screw Mount
<b>Dimensions (mm)</b>	80 x 74 x 25.6
<b>Max. Tighten Torque (Nm)</b>	5 Nm
<b>Radome Type</b>	PC+ASA
<b>Radome Color</b>	Black, White
<b>Operating Temperature (C)</b>	-40 to +85
<b>Storage Temperature (C)</b>	-40 to +85
<b>Substance Compliance</b>	RoHS
<b>Certificates</b>	Iridium Certified, IP67, IP69

### 3. Antenna parameters

Cable 1: 5GNR

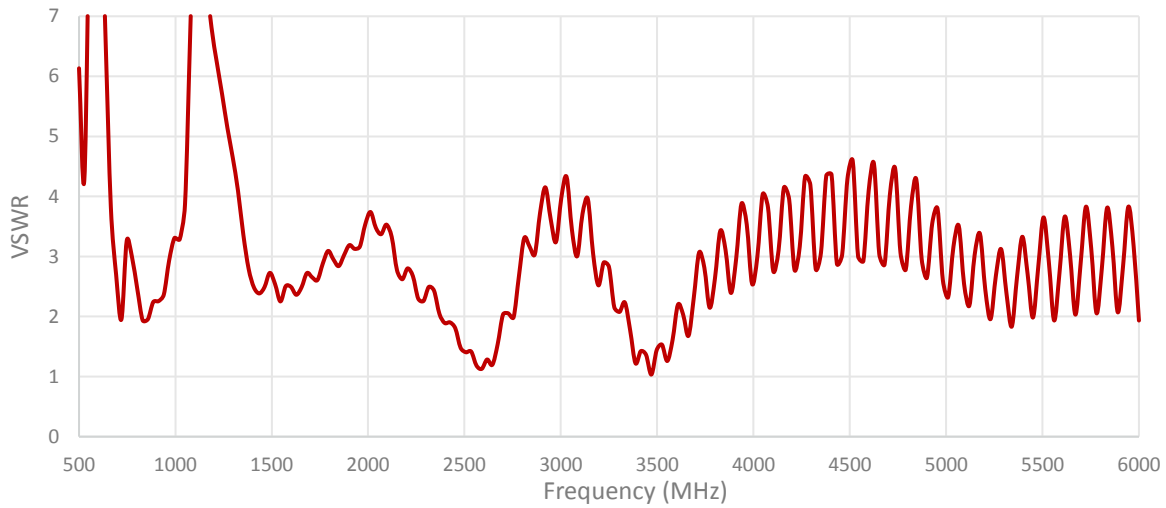
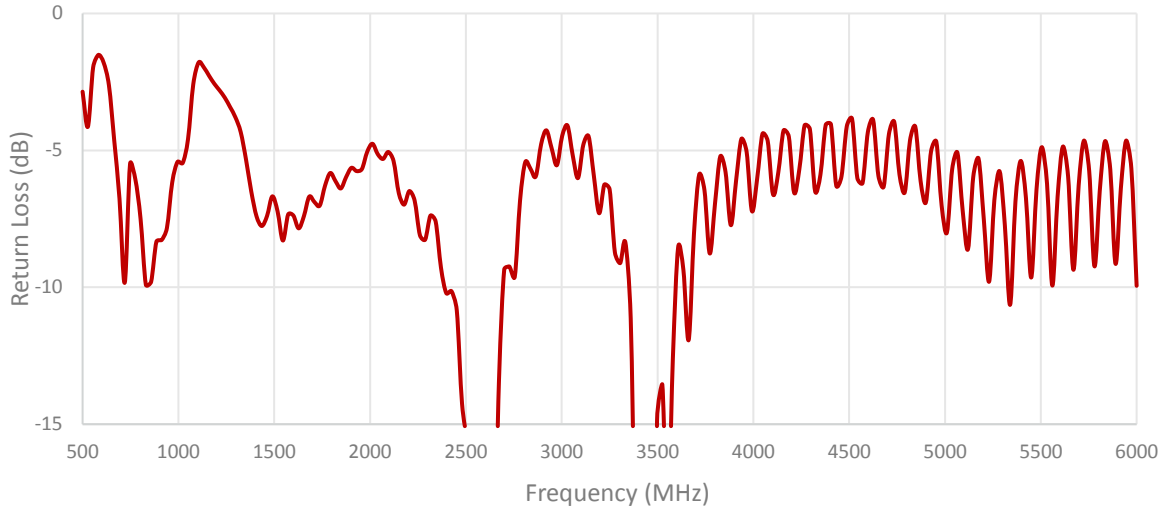

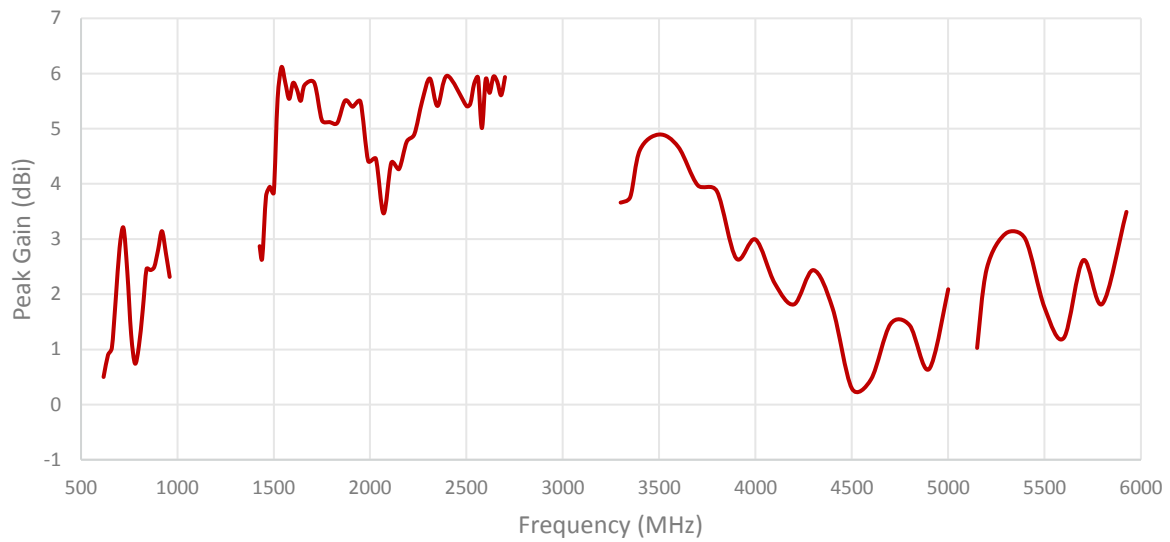
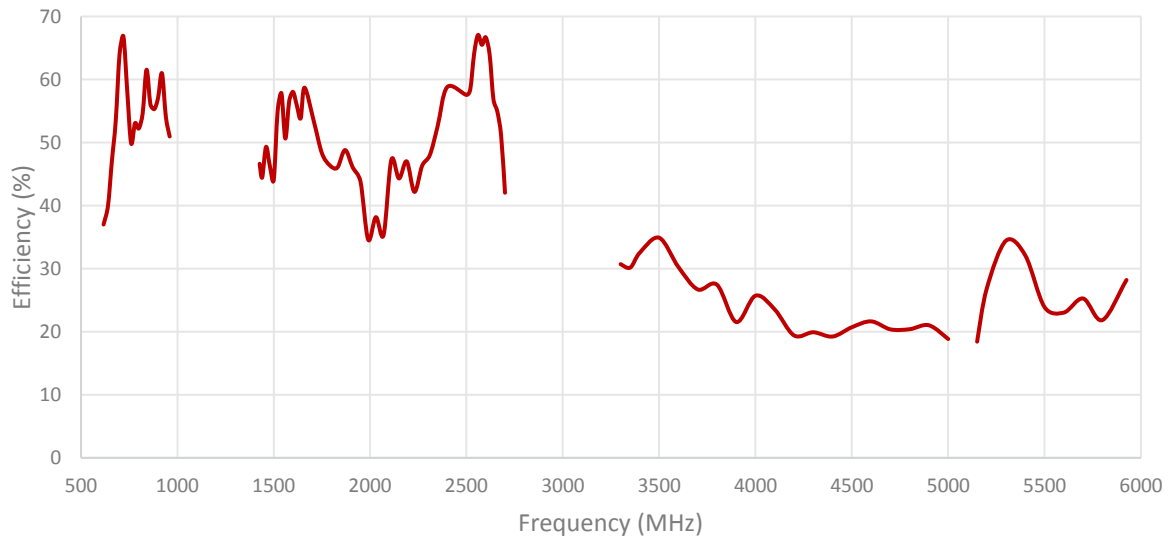

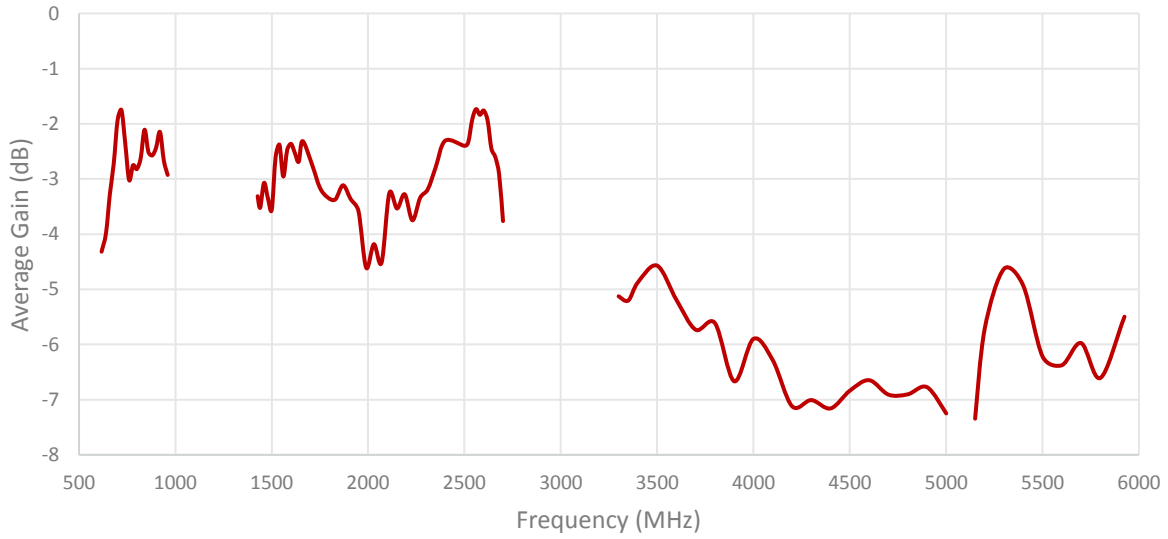

**Cable 2: IRIDIUM**

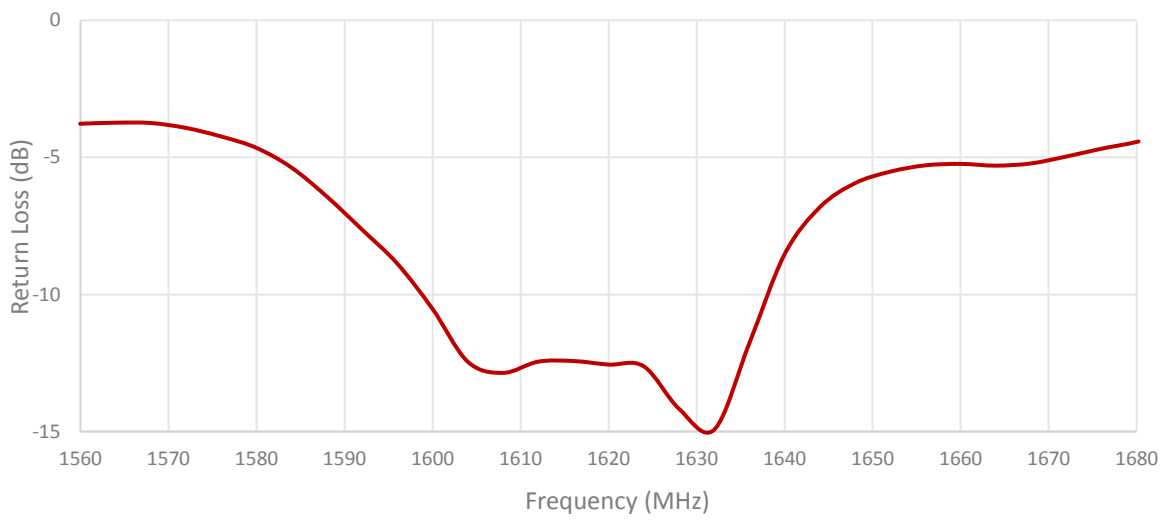

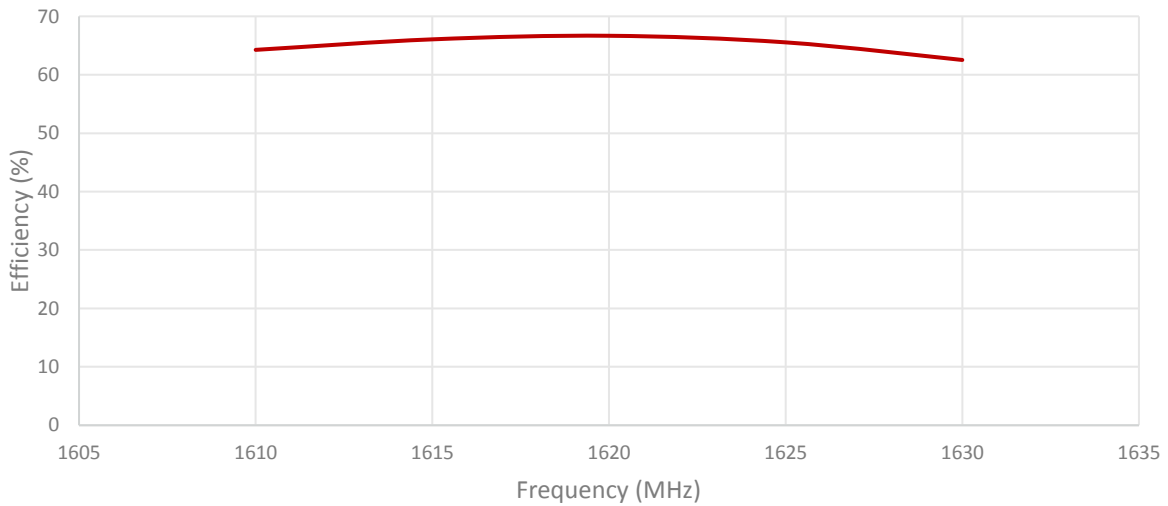
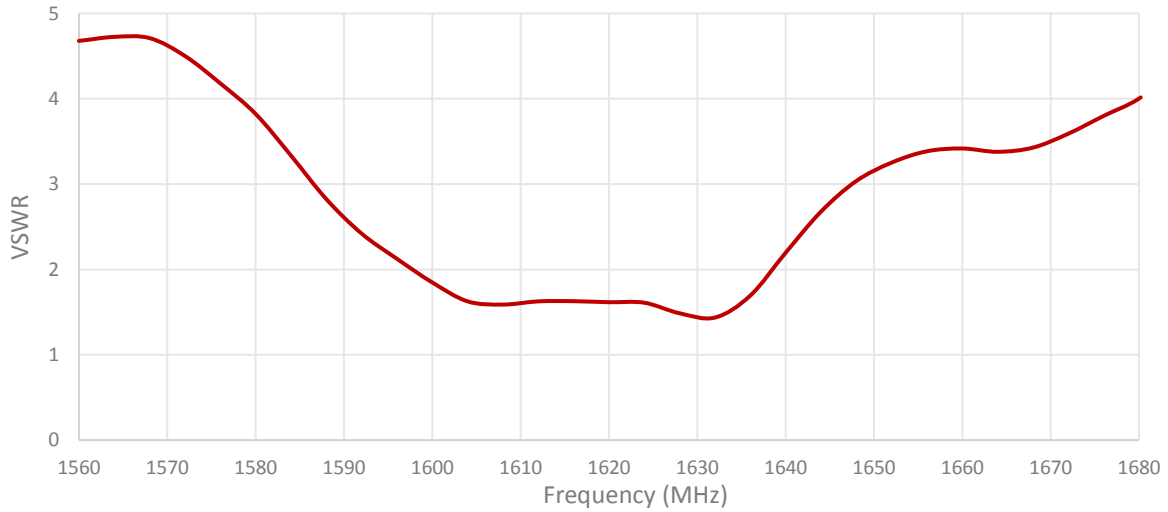



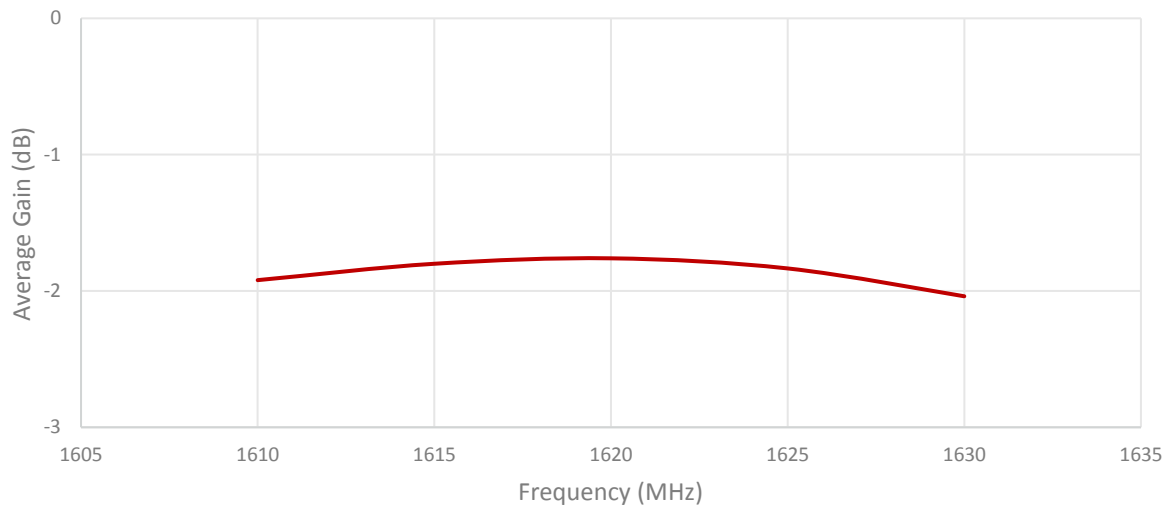
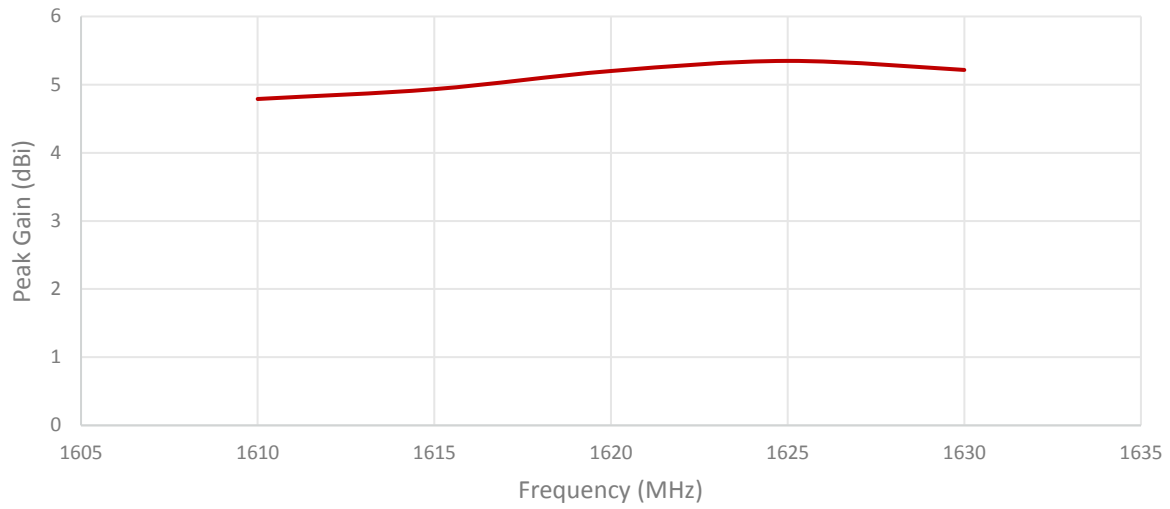

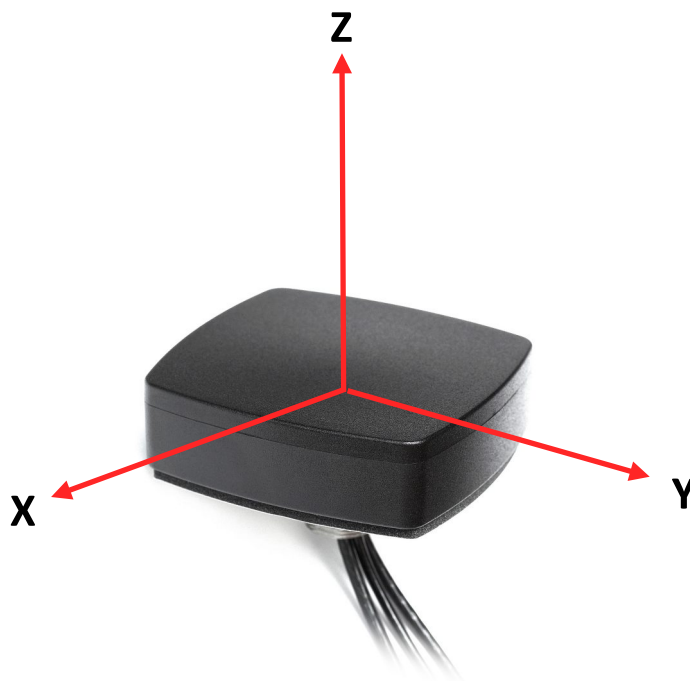

Radiation pattern reference

Cable 1: 5GNR

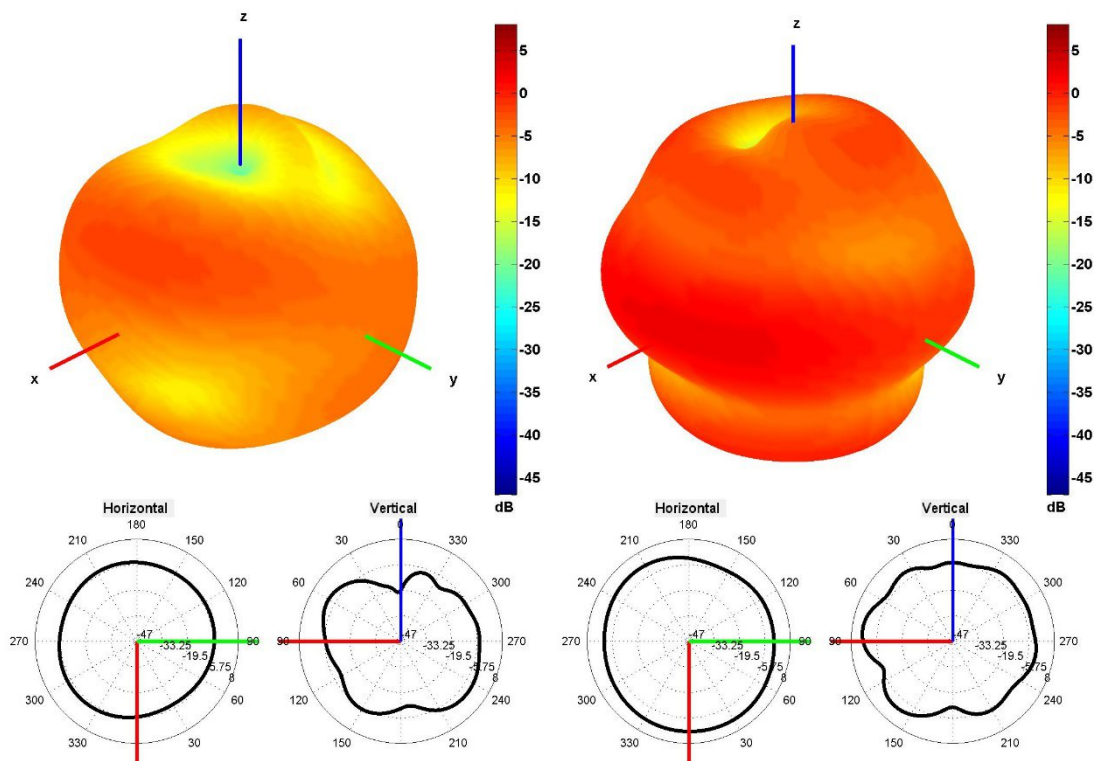

650 and 750 MHz Radiation pattern

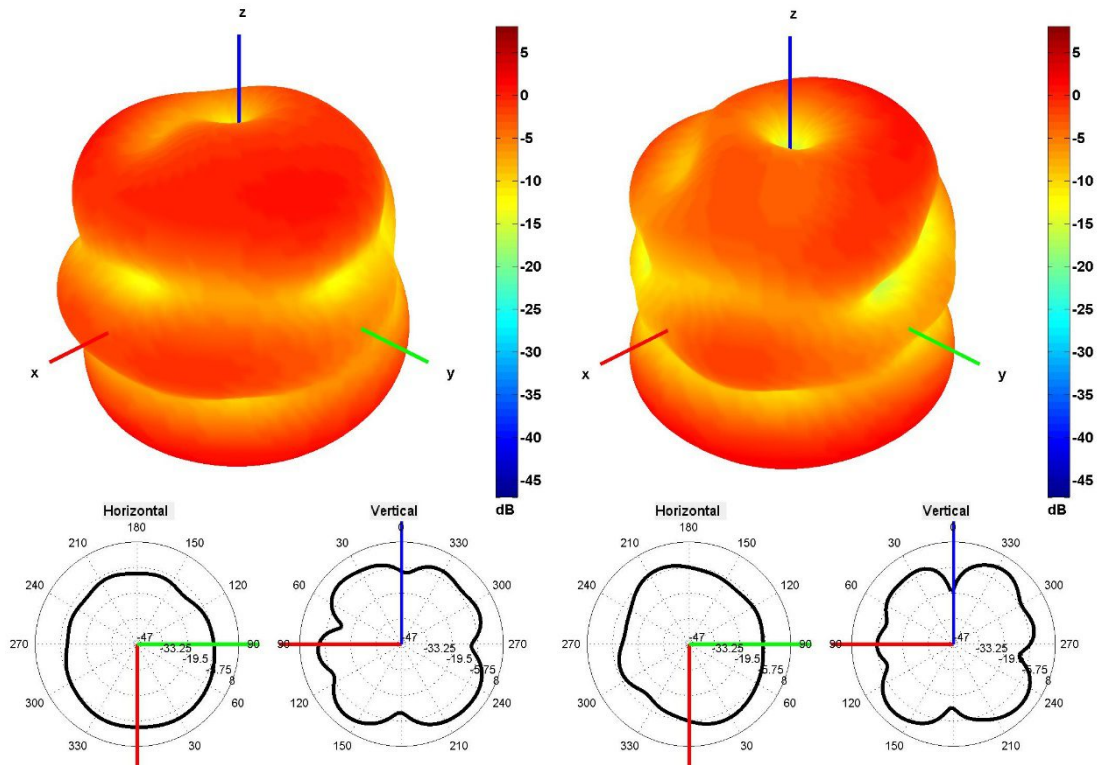

850 and 940 MHz Radiation pattern

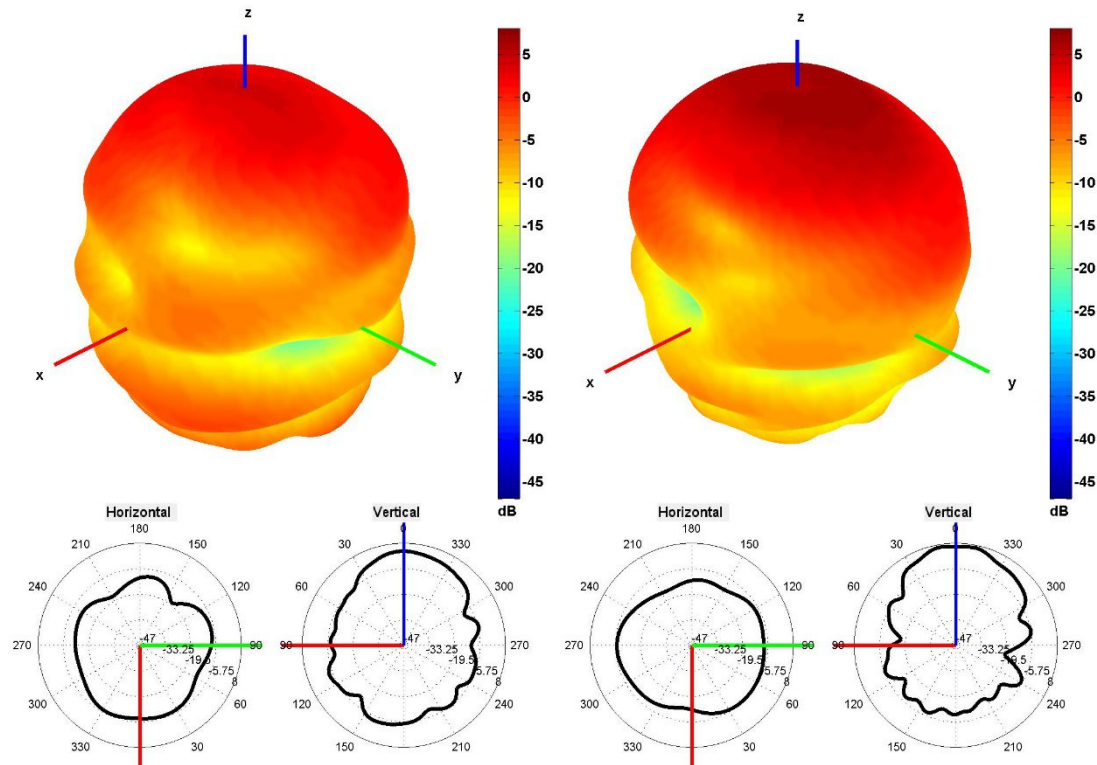

1500 and 1600 MHz Radiation pattern

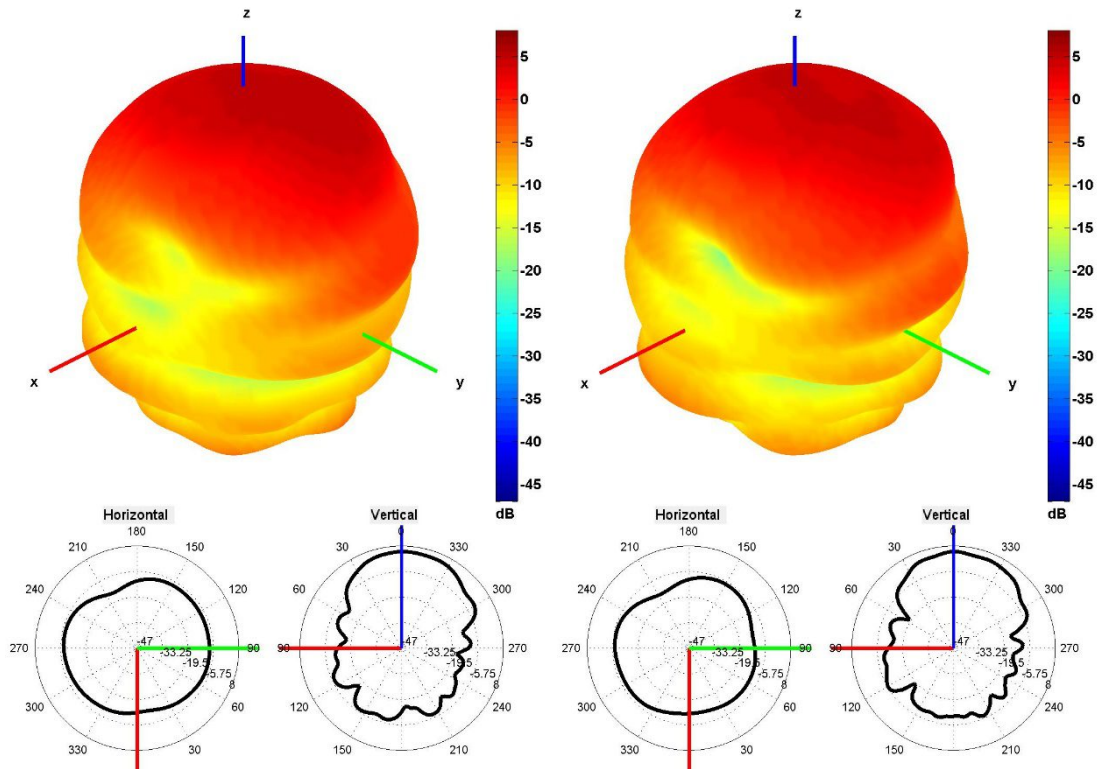

1750 and 1850 MHz Radiation pattern

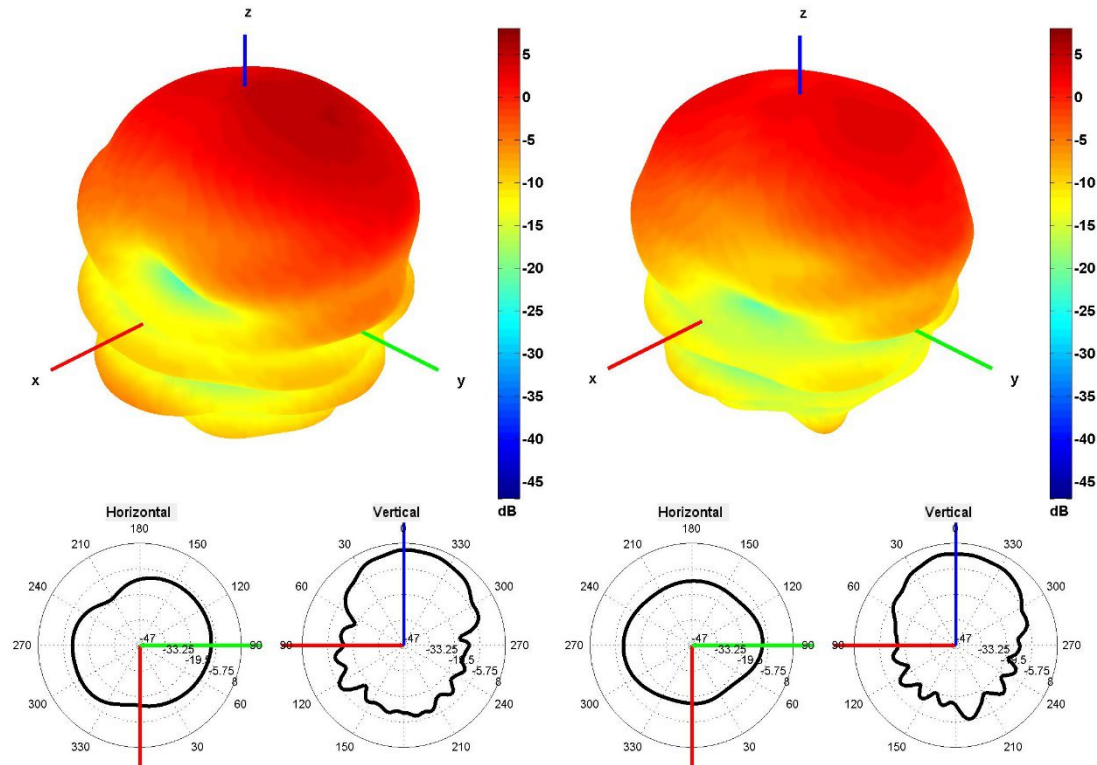

1950 and 2100 MHz Radiation pattern

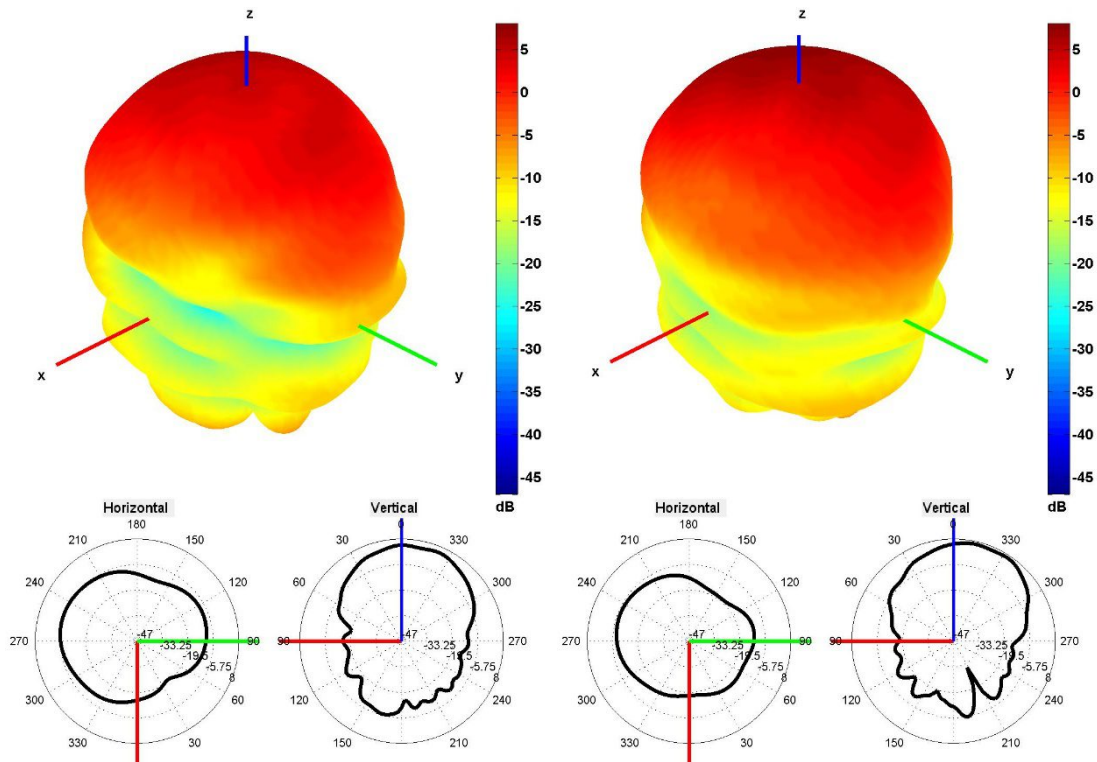

2350 and 2600 MHz Radiation pattern

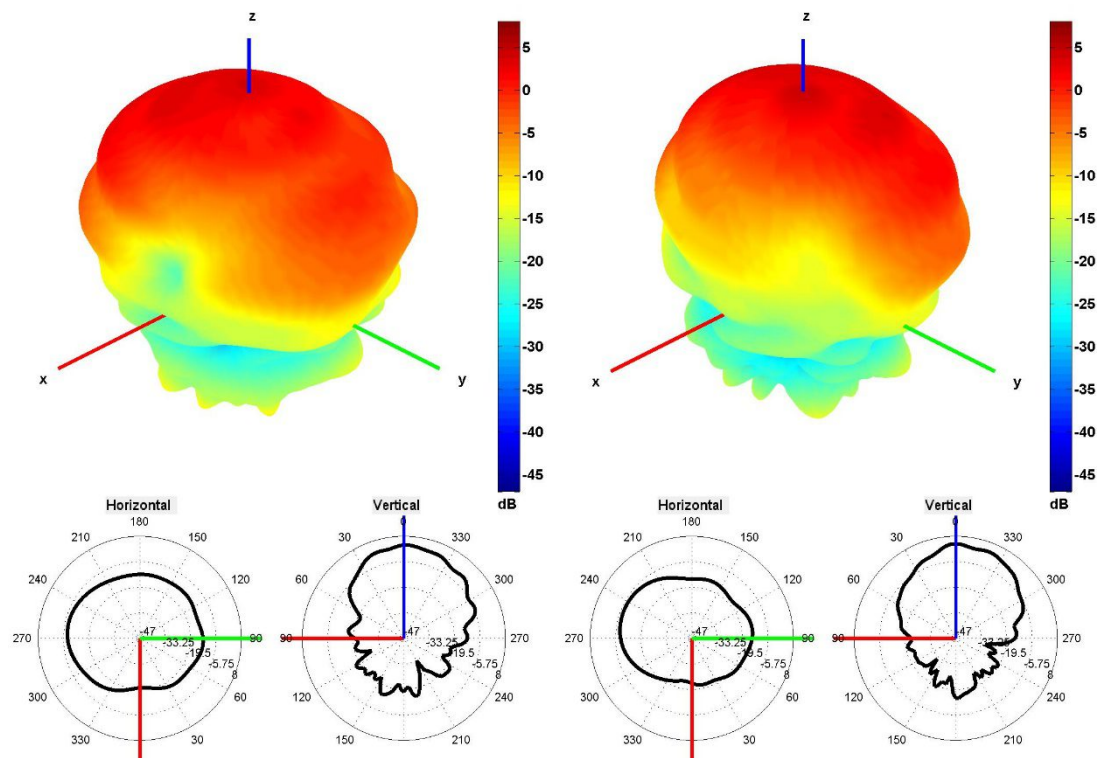

3350 and 3600 MHz Radiation pattern

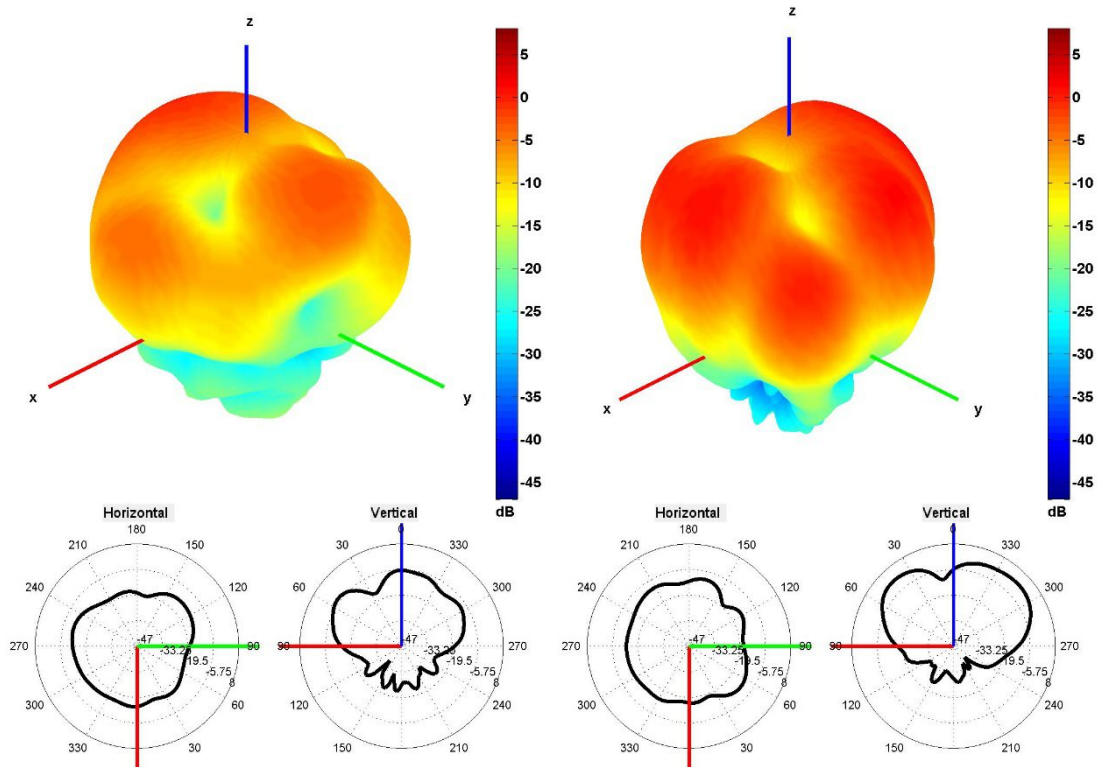

4500 and 5500 MHz Radiation pattern

Cable 2: IRIDIUM

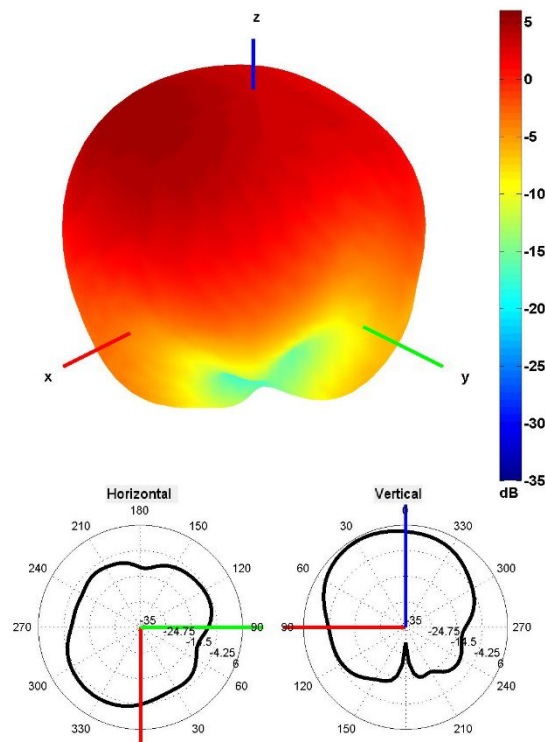

1621 MHz Radiation pattern

## 4. Antenna drawings

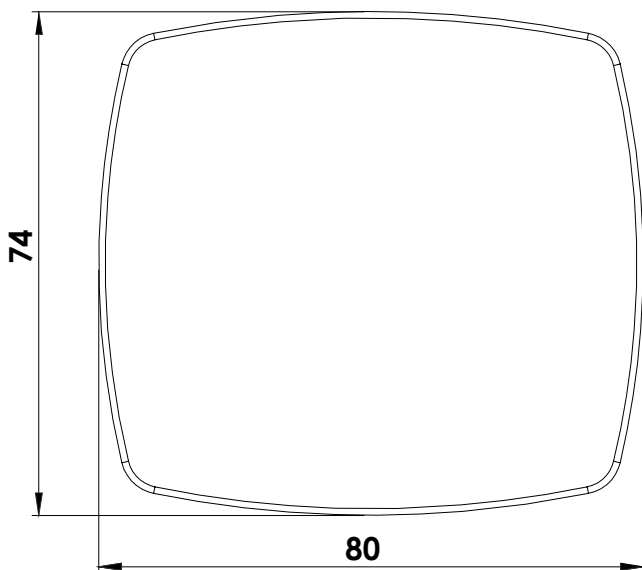
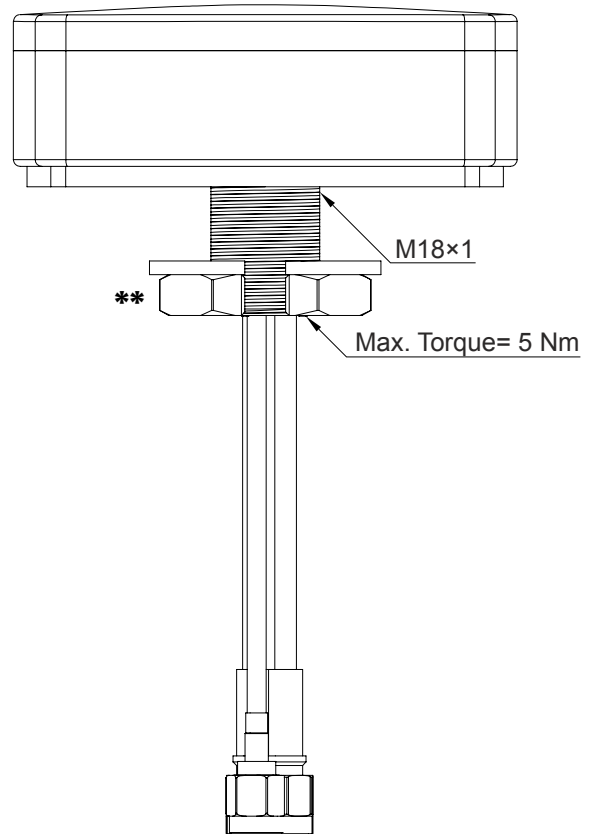
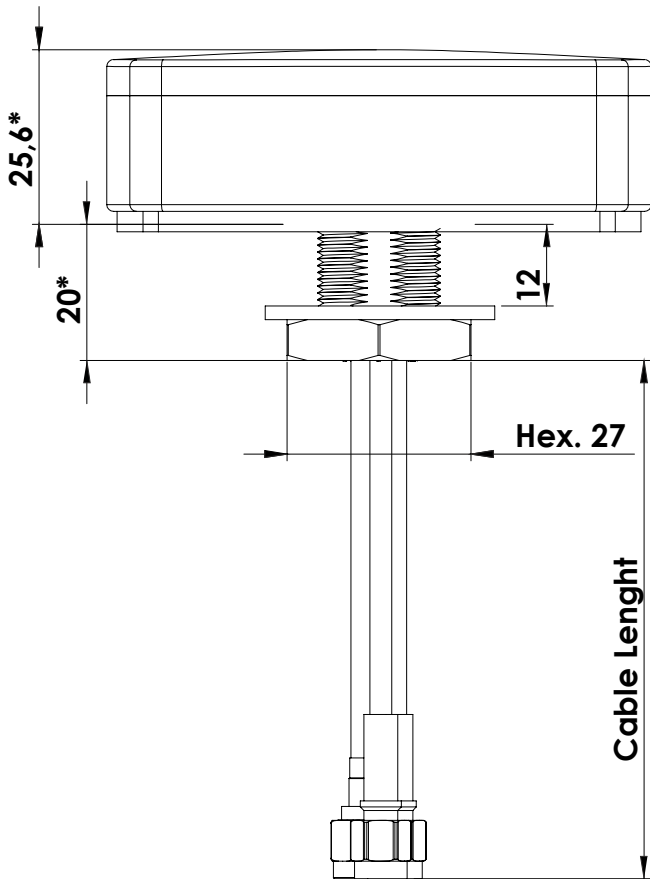

### Mounting hole

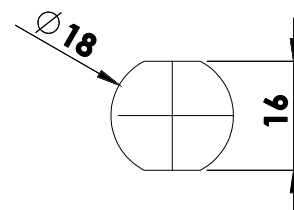

Max. mounting thickness 12mm  
 Note: Dimensions are in millimeters  
 \*Dimensions are after mounting  
 \*\*Max. Torque= 5 Nm

5. Antenna Images

