

回転形モータ駆動ボリューム

Rotary Motor-driven Potentiometers

豊富なバラエティで各種機器をリモートコントロール。
Available in variety for remote control of various equipment.

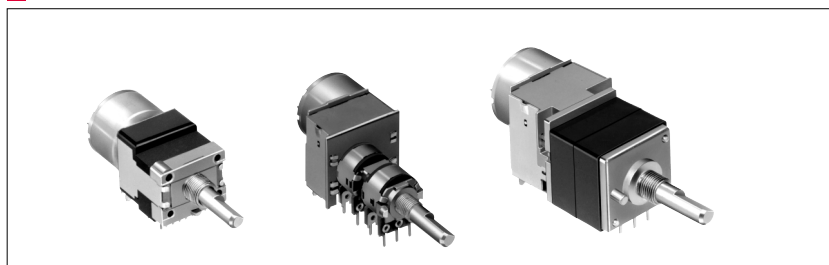

■ 特長

- オーディオ各種機器のボリュームを、リモートコントロール。
- モータ駆動および手動操作可能。

■ 用途

- アンプ、CDプレーヤ、ラジカセなどの音量コントロール用ボリューム

■ Features

- Potentiometers for various audio products can be remote-controlled.
- Permits motor driving and manual operation.

■ Applications

- For volume control in amplifiers, CD players, radio-cassettes, etc.

■ 製品一覧 Products Line

タイプ Type	連数 Number of unit	製品名 Model	モータ仕様 Motor type		モータ 印加電圧 Motor voltage (V DC)	ボリューム回転速度 Potentiometer rotational speed (sec/300°)	動作最大 電流値 Max. operating current (mA)
			シールドケース Sealed case	モータプリント 端子 Motor printed terminal			
16形 16mm size	1軸2連	Single-shaft, dual-unit	なし あり Without With	なし あり Without With	4 to 6 (標準:4.5) (Standard:4.5)	12±3 (4.5V DC)	回転時 At rotation 100 端末スリップ時 At end slip 150 (4.5V DC)
	1軸4連	Single-shaft, quad.-unit					
	1軸5連	Single-shaft, 5-ganged-unit					
	1軸6連	Single-shaft, 6-ganged-unit					
16形 照光式 貫通軸タイプ 16mm size illuminated, through-shaft type	1軸2連	Single-shaft, dual-unit					
	1軸4連	Single-shaft, quad.-unit					
	1軸5連	Single-shaft, 5-ganged-unit					
16形 16mm size	1軸2連	Single-shaft, dual-unit					
	1軸4連	Single-shaft, quad.-unit					
16形 照光式 前面タイプ 16mm size illuminated, front- mounting type	1軸2連	Single-shaft, dual-unit					
	1軸4連	Single-shaft, quad.-unit					
18形 18mm size	1軸2連	Single-shaft, dual-unit					
	1軸4連	Single-shaft, quad.-unit					
27形 27mm size	1軸2連	Single-shaft, dual-unit					
	1軸4連	Single-shaft, quad.-unit					

16形 (RK168シリーズ) 軸の種類 16mm Size (RK168 Series) Shaft Style

Unit : mm

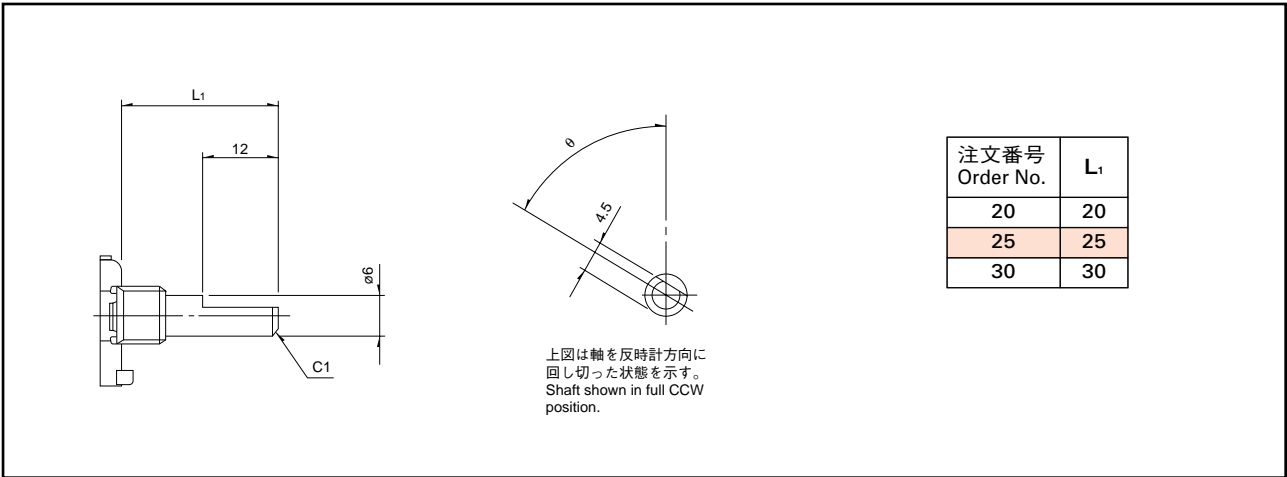

注記 Note

- 部が当社推奨仕様です。
- shows the specification recommended by us.

16形 (RK168シリーズ) 軸受およびシャーシ止め標準寸法 16 Size (RK168 Series) Standard Dimensions of Bushing and Fixing Lug

Unit : mm

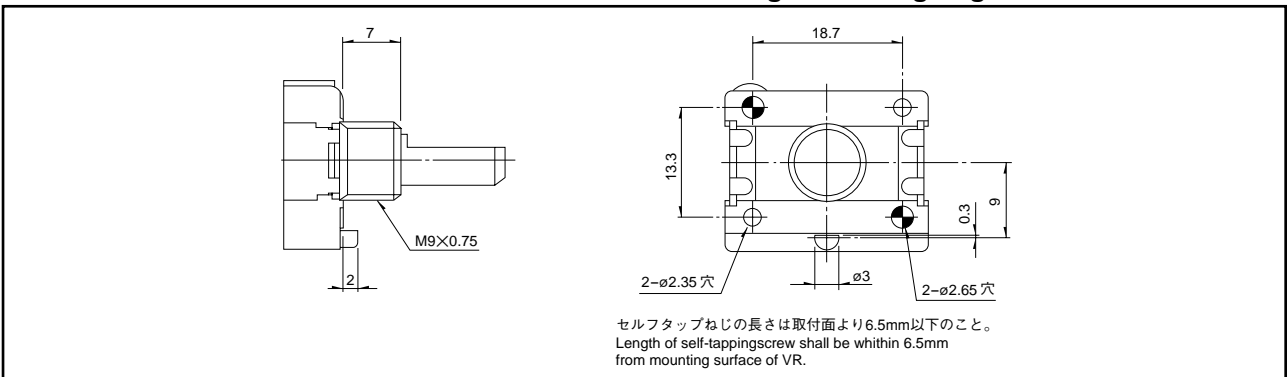

注記 Note

※RK168シリーズ以外の製品の軸、軸受およびシャーシ止めの標準寸法は次のとおりです。

- (1) RK163シリーズ：金属軸16形ボリューム (65ページ) に準じます。
- (2) RK181シリーズ：金属軸18形ボリューム (70ページ) に準じます。
- (3) RK271シリーズ：金属軸27形ボリューム (74ページ) に準じます。

※The standard dimensions of the shaft, shaft bushing and fixing lug of products other than the RK168-Series parts are as follows.

- (1) RK163 Series: They correspond to the Type-16 metallic shaft volume controls. (Refer to P.65.)
- (2) RK181 Series: They correspond to the Type-18 metallic shaft volume controls. (Refer to P.70.)
- (3) RK271 Series: They correspond to the Type-27 metallic shaft volume controls. (Refer to P.74.)

モータプリント端子形状 Style of Printed Terminal for Motor

Unit : mm

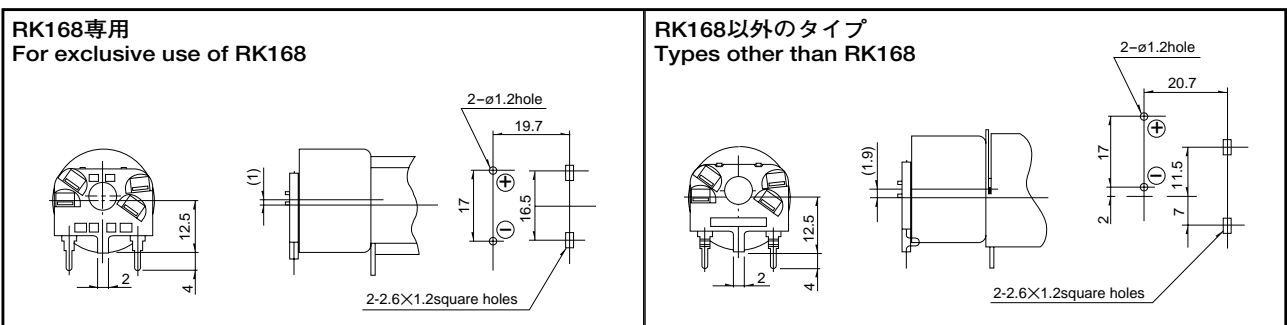

Rotary Motor-driven Potentiometers

P
R
O
T
A
R
Y
O

S
I
D
E

T
R
I
M







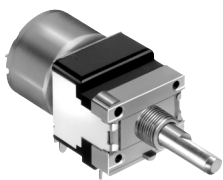

K
S
T
I
C

E
R
O
T
A
R
Y
D

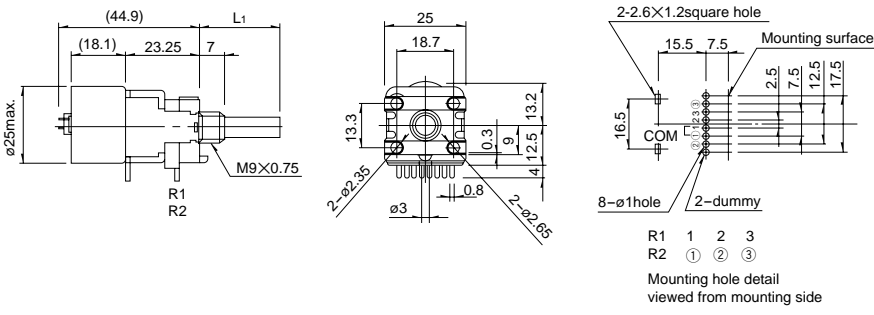
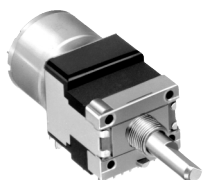
P
O
S
I
T
I
O
N

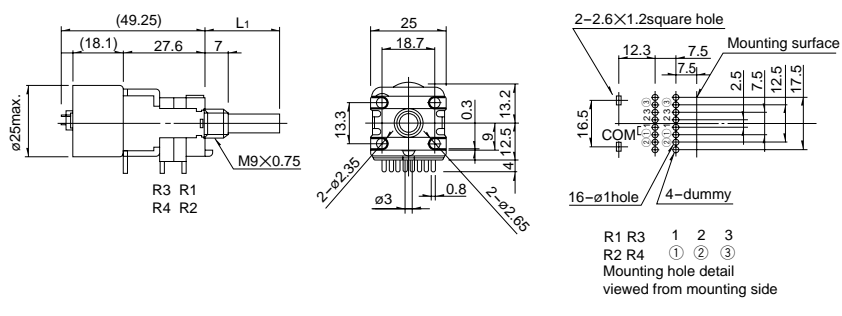
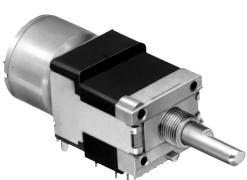
■ 外形図 Dimensions

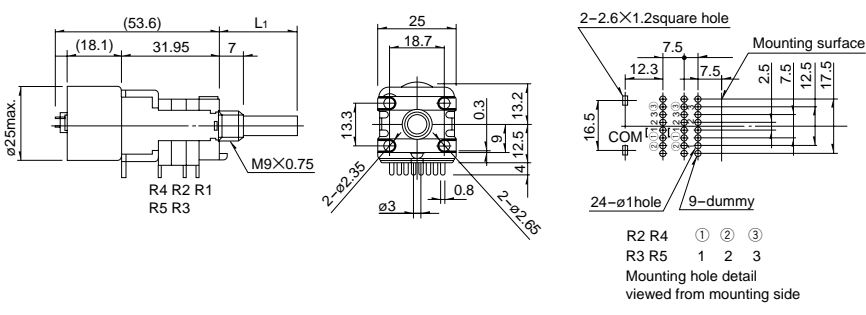
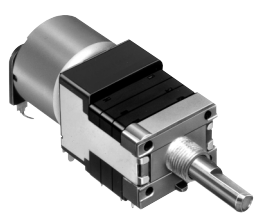
Unit : mm

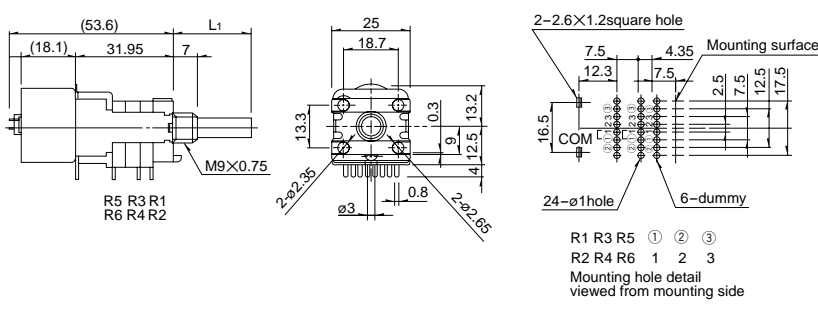





製品名 Model	外形図 Dimensions
16形 16mm size 1軸2連 Single-shaft, dual-unit RK16812MG  最小包装単位 Minimum packing unit 100 pcs. 	
16形 16mm size 1軸4連 Single-shaft, quad.-unit RK16814MG  最小包装単位 Minimum packing unit 100 pcs. 	
16形 16mm size 1軸5連 Single-shaft, 5-ganged-unit RK16815MG  最小包装単位 Minimum packing unit 100 pcs. 	
16形 16mm size 1軸6連 Single-shaft, triple-unit RK16816MG  最小包装単位 Minimum packing unit 100 pcs. 	

注記
NoteOVERSEAS
PRODUCTS
2000

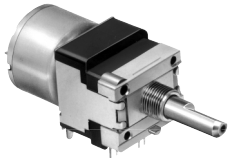
このマークのついている製品は、日本生産のほか、海外生産も行っております(一部の製品については、海外生産のみとなっております)。
 The products with this mark are produced in Japan and overseas. (Some products are produced overseas only.)

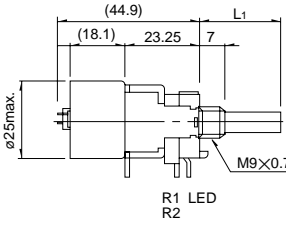
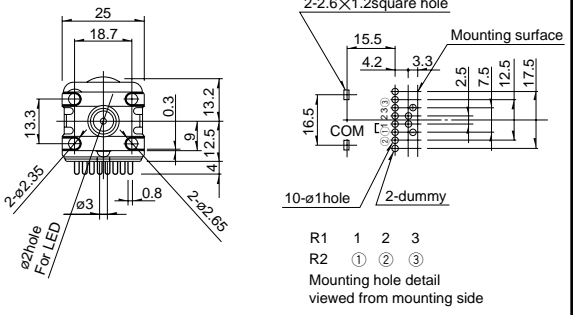
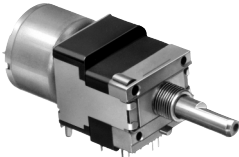
■ 外形図 Dimensions

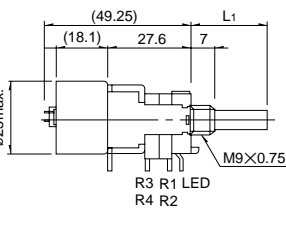
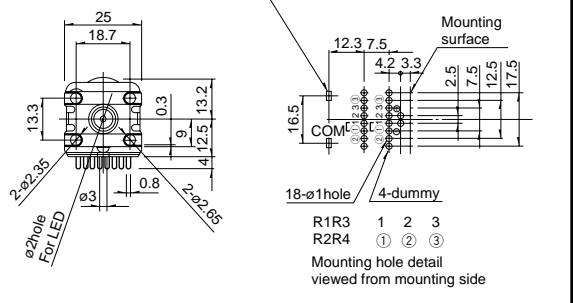
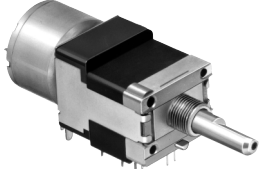
Unit : mm

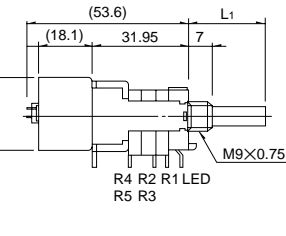
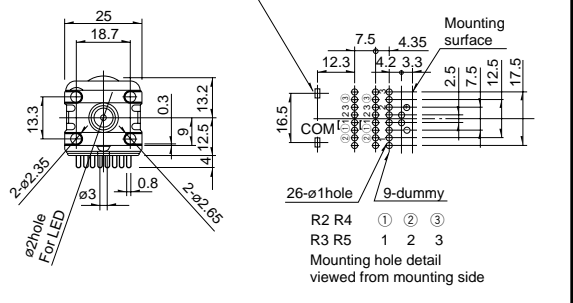
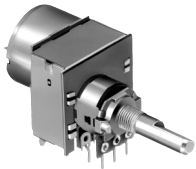
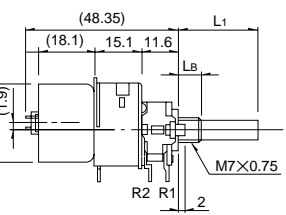
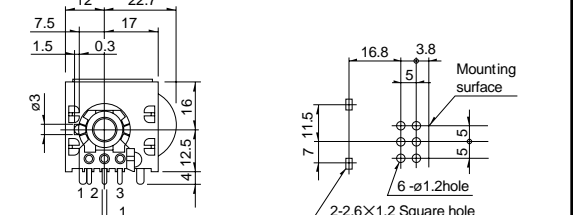
製品名 Model	外形図 Dimensions		
<p>16形 16mm size 1軸2連 Single-shaft, dual-unit 照光式貫通軸タイプ Illuminated, through-shaft type RK16812MGL</p>  <p>最小包装単位 Minimum packing unit 100 pcs.</p> 		 <p>R1 1 2 3 R2 ① ② ③ Mounting hole detail viewed from mounting side</p>	
<p>16形 16mm size 1軸4連 Single-shaft, quad.-unit 照光式貫通軸タイプ Illuminated, through-shaft type RK16814MGL</p>  <p>最小包装単位 Minimum packing unit 100 pcs.</p> 		 <p>R1R3 1 2 3 R2R4 ① ② ③ Mounting hole detail viewed from mounting side</p>	
<p>16形 16mm size 1軸5連 Single-shaft, 5-ganged-unit 照光式貫通軸タイプ Illuminated, through-shaft type RK16815MGL</p>  <p>最小包装単位 Minimum packing unit 100 pcs.</p> 		 <p>R2 R4 ① ② ③ R3 R5 1 2 3 Mounting hole detail viewed from mounting side</p>	
<p>16形 16mm size 1軸2連 Single-shaft, dual-unit RK16312MC</p>  <p>最小包装単位 Minimum packing unit 100 pcs.</p>		 <p>Mounting hole detail viewed from mounting side</p>	

注記
Note



このマークのついている製品は、日本生産のほか、海外生産も行っております（一部の製品については、海外生産のみとなっております）。
The products with this mark are produced in Japan and overseas. (Some products are produced overseas only.)

Rotary Motor-driven Potentiometers

■ 外形図 Dimensions

Unit : mm

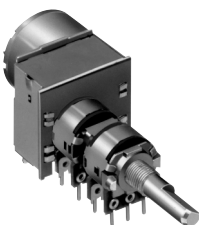
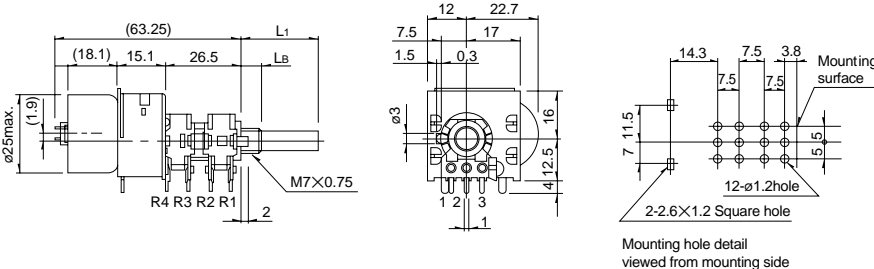
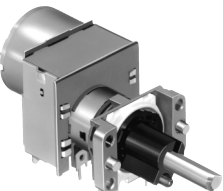
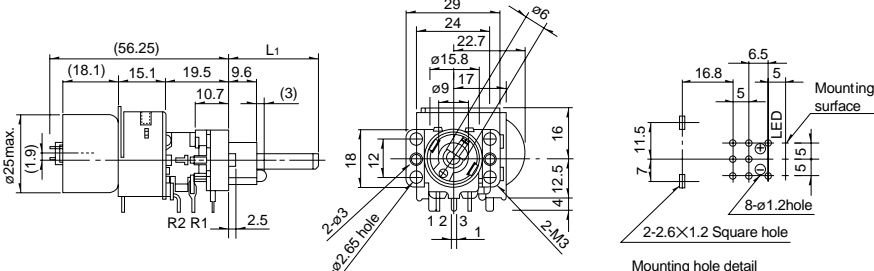
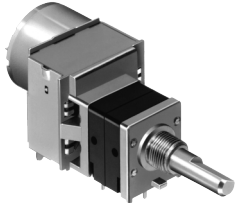
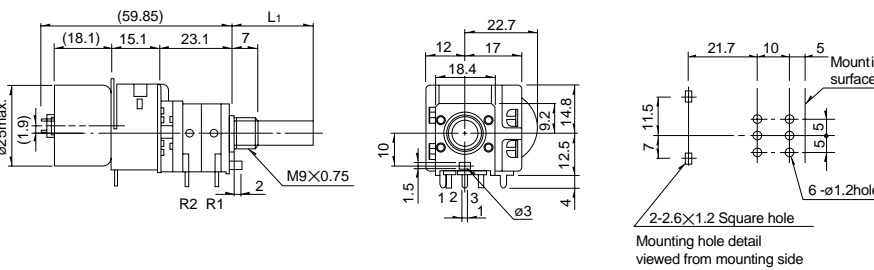
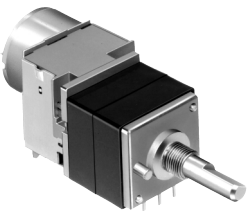
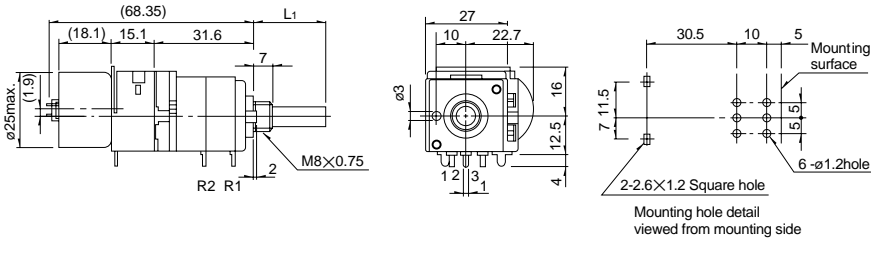
製品名 Model	外形図 Dimensions
<p>16形 16mm size 1軸4連 Single-shaft, quad.-unit RK16314MC</p>  <p>最小包装単位 Minimum packing unit 100 pcs.</p>	 <p>Mounting hole detail viewed from mounting side</p>
<p>16形 16mm size 1軸2連 Single-shaft, dual-unit 照光式前面タイプ Illuminated, through-shaft type RK16312MCL</p>  <p>最小包装単位 Minimum packing unit 100 pcs.</p>	 <p>Mounting hole detail viewed from mounting side</p>
<p>18形 18mm size 1軸2連 Single-shaft, dual-unit RK18112MC</p>  <p>最小包装単位 Minimum packing unit 100 pcs.</p>	 <p>Mounting hole detail viewed from mounting side</p>
<p>27形 27mm size 1軸2連 Single-shaft, dual-unit RK27112MC</p>  <p>最小包装単位 Minimum packing unit 100 pcs.</p>	 <p>Mounting hole detail viewed from mounting side</p>