

2JF1424P

CELLULAR / LTE Flexible Polymer

Key Features

CELLULAR / LTE

- 698-960 MHz
- 1710-2170 MHz
- 2500-2700 MHz

Self-Adhesive

Left-Hand Feed

Small Size

High Performance

Flexible Material

Ground Plane Dependent

Dimensions 40 × 20 × 0.2 mm

Customizable Cable and Connector

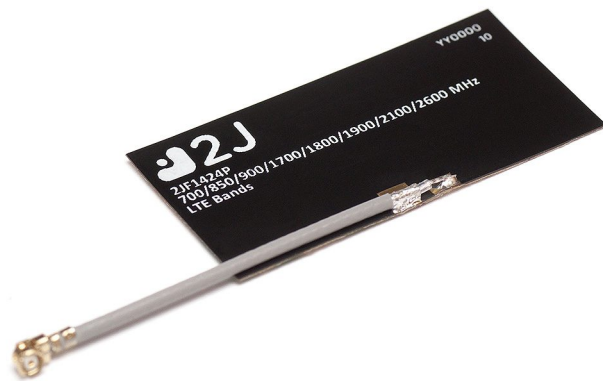

Note: Antenna integration based on Application Note (page 9 - 17).



1. Antenna and electrical specifications

Parameters	CELLULAR / LTE Antenna		
Standards	2G,3G and 4G		
Band (MHz)	700/850/900	1700/1800/1900/2100	2600
Frequency (MHz)	698-960	1710-2170	2500-2700
Return Loss (dB)	~-10.8	~-7.5	~-8.0
VSWR	~2.1:1	~2.5:1	~2.6:1
Efficiency (%)	~69.0	~65.8	~56.3
Peak Gain (dBi)	~4.1	~2.7	~2.2
Average Gain (dB)	~-1.7	~-1.9	~-2.5
Impedance (Ohm)	50		
Polarisation	Linear		
Radiation Pattern	Omni-Directional		
Max. Input Power (W)	25		
Connector Type	U.FL Standard (Other Connectors Available)		
Cable Length	38mm Standard (Other Cable Length Limited - see Application Note)		
Cable Type	1.37mm Mini-Coax Standard (Other Cables Available)		

Antenna Measurement Conditions:

Measure on Free Space on a 110x40 mm Ground plane

38 mm of 1.37 mm Mini-Coax Cable

Measured in Certified CTIA 3D Anechoic

2. Mechanical and environmental specifications

Specifications	2JF1424P
Mounting Type	Self-Adhesive
Dimensions (mm)	40 × 20 × 0.2
Adhesive Type	3M 467MP
Material	Flexible Polymer
Operating Temperature (C)	-40 to +85
Storage Temperature (C)	-40 to +85
Substance Compliance	RoHS

3. Antenna parameters

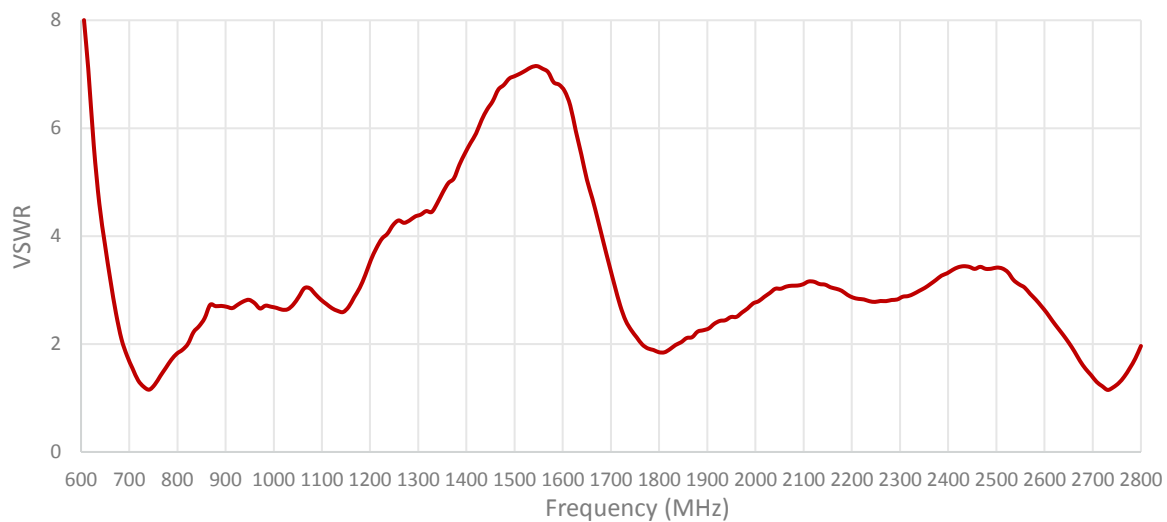
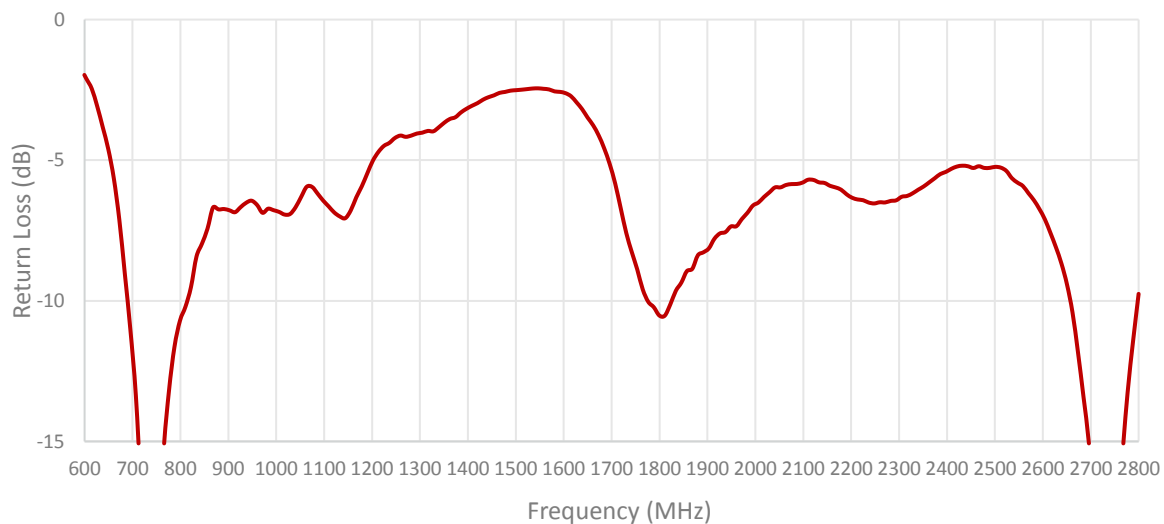

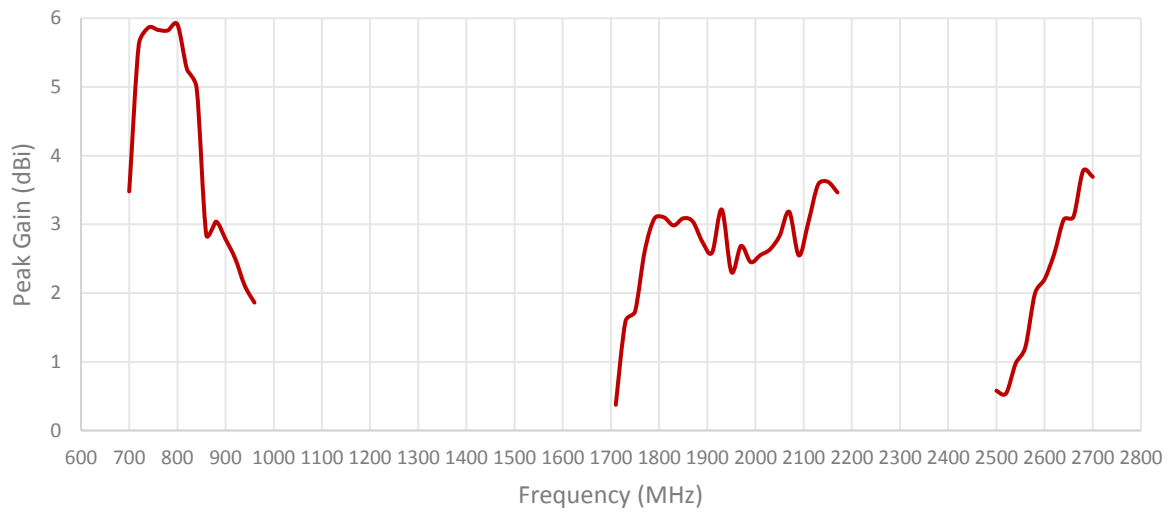
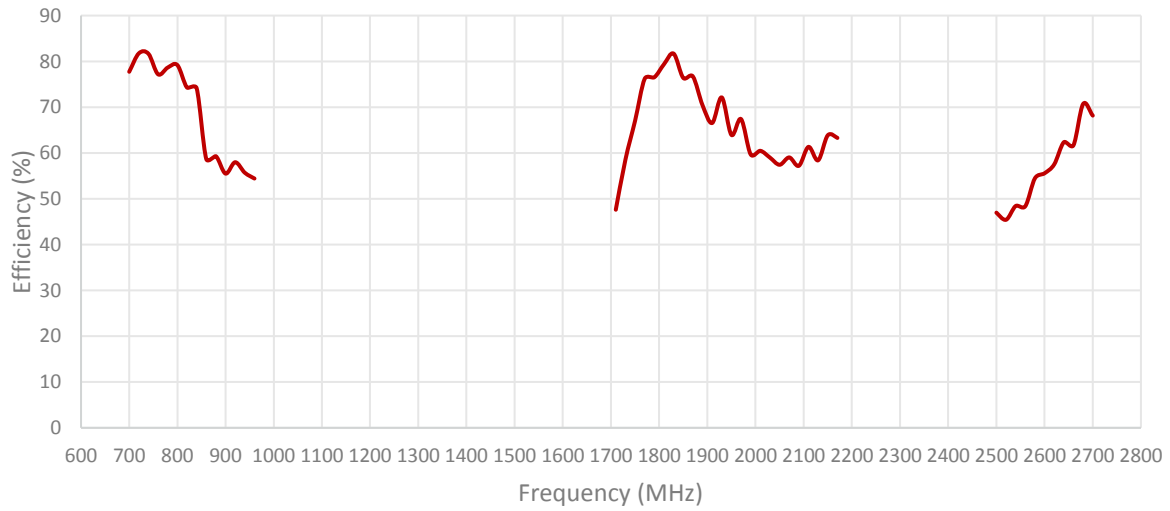

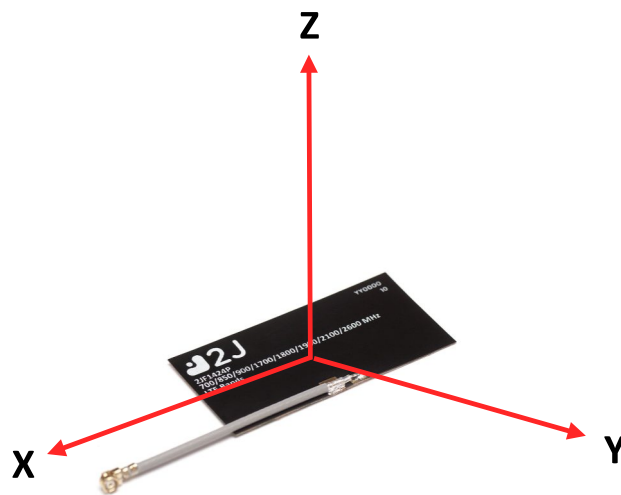
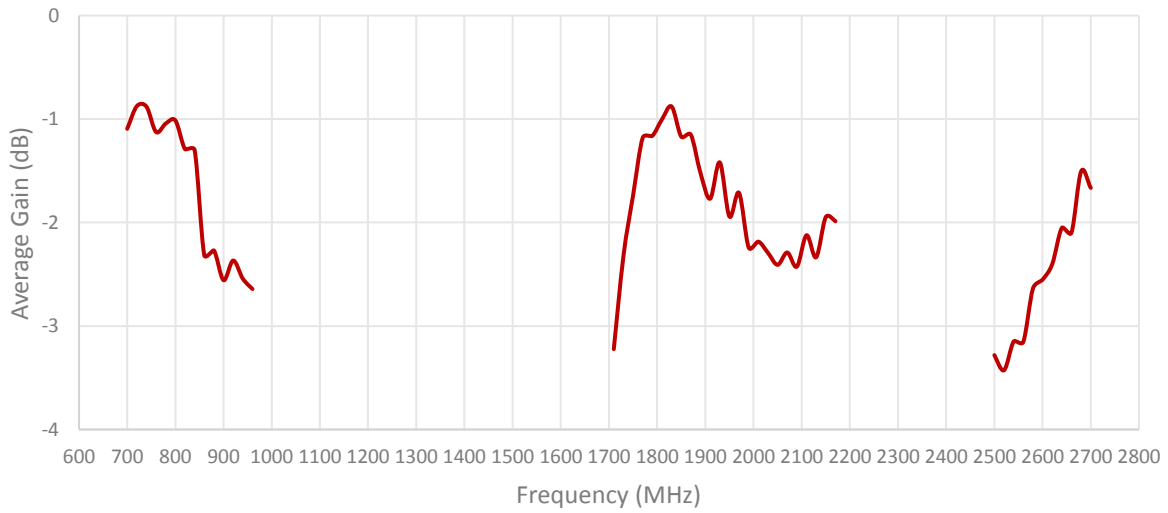

Radiation pattern reference

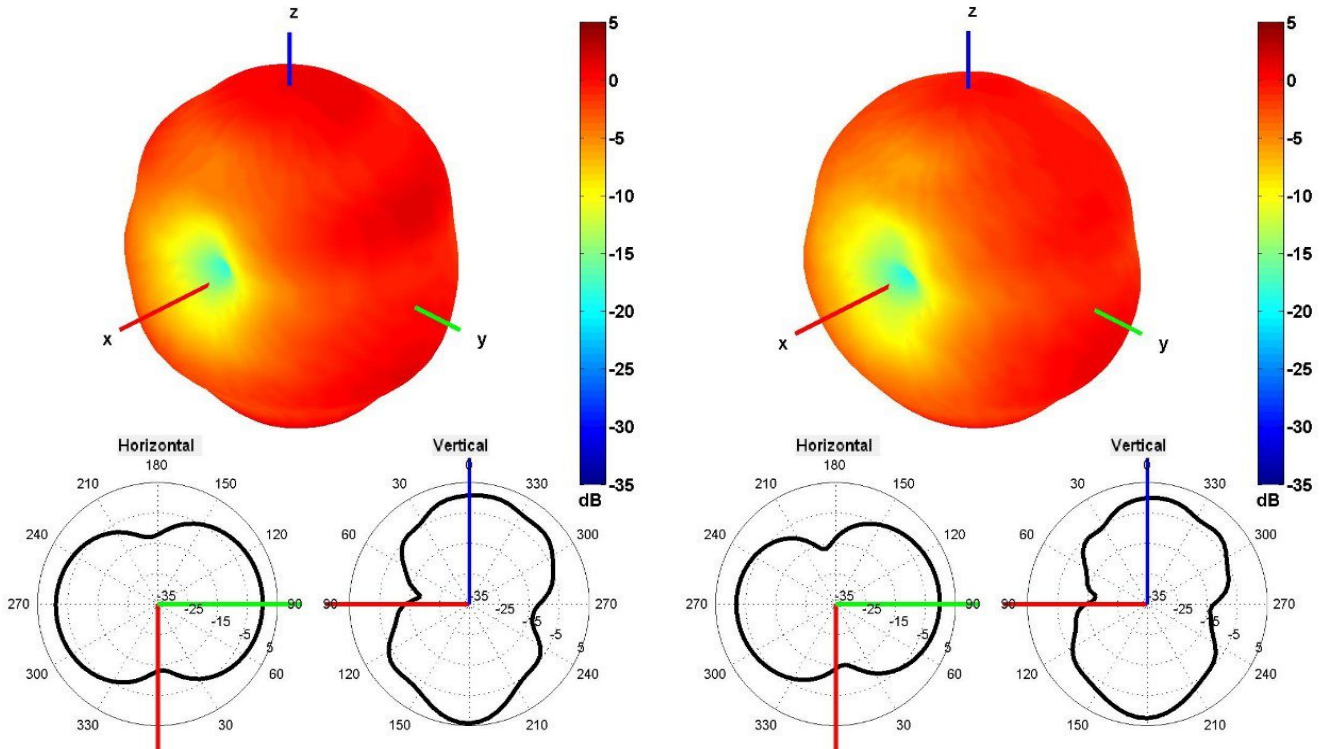

750 and 850 MHz Radiation pattern

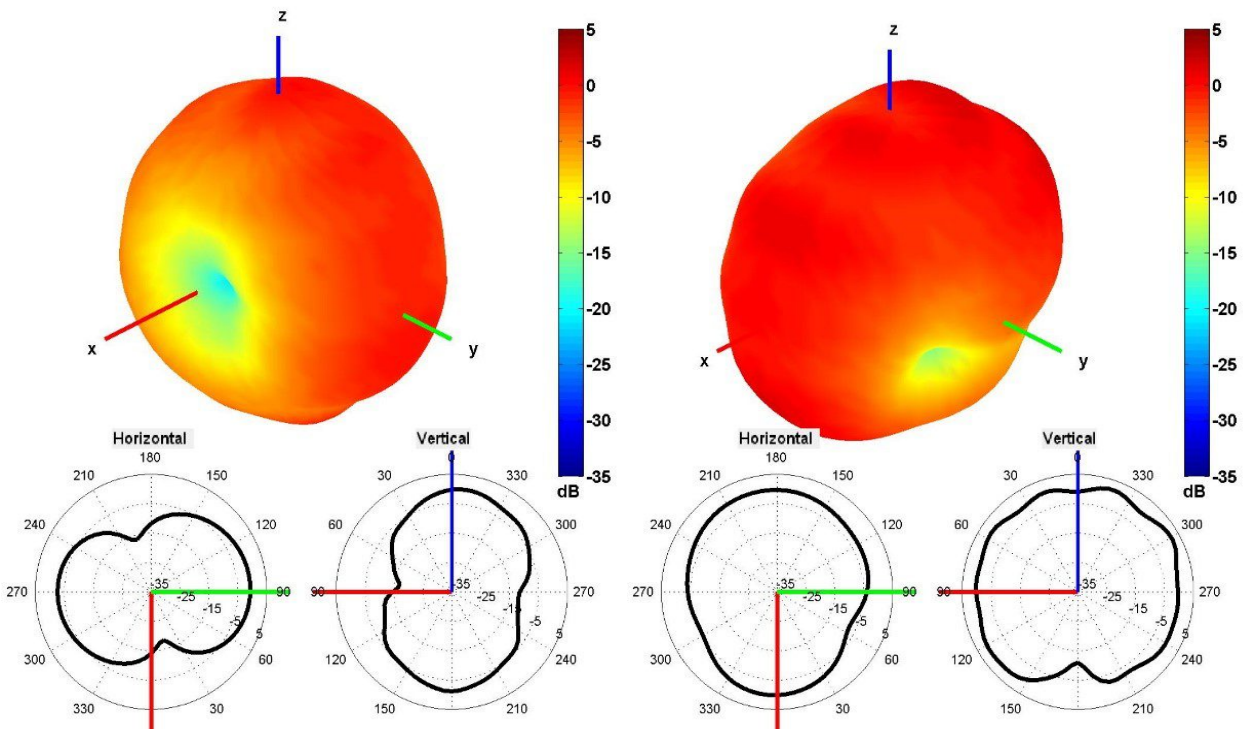

940 and 1750 MHz Radiation pattern

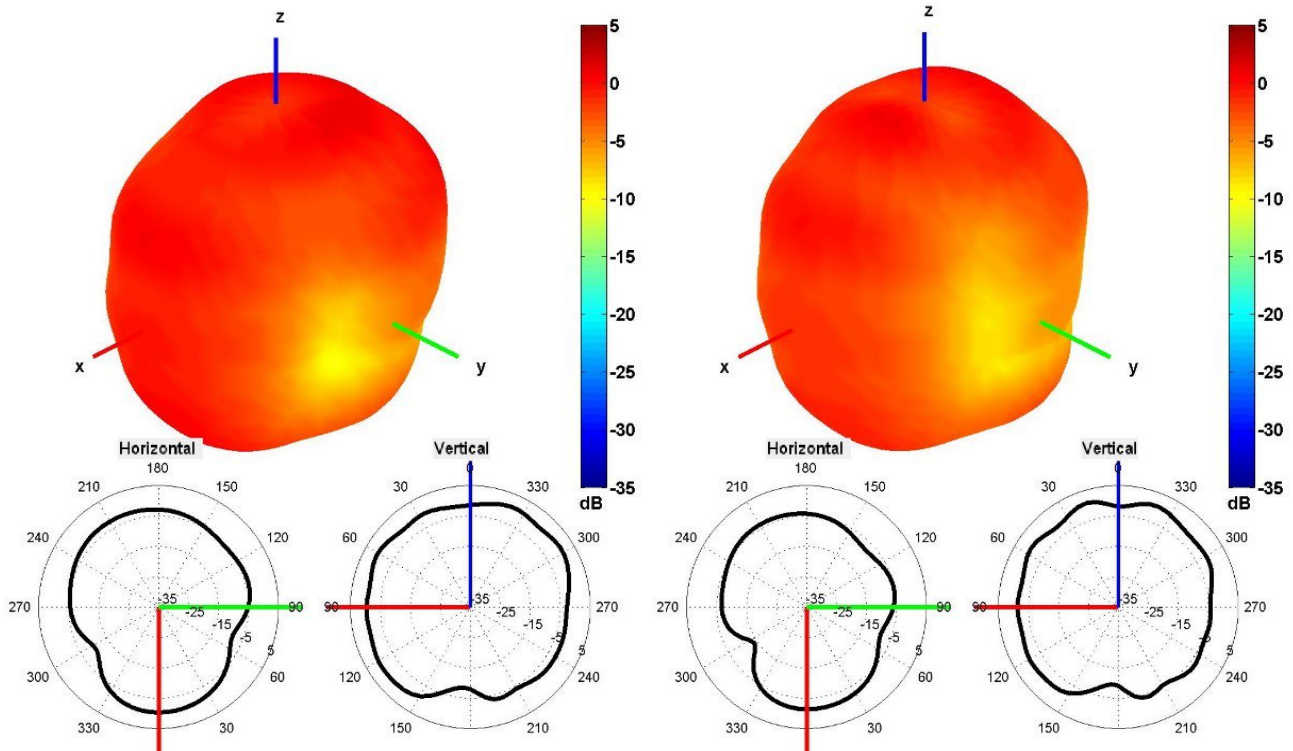

1850 and 1950 MHz Radiation pattern

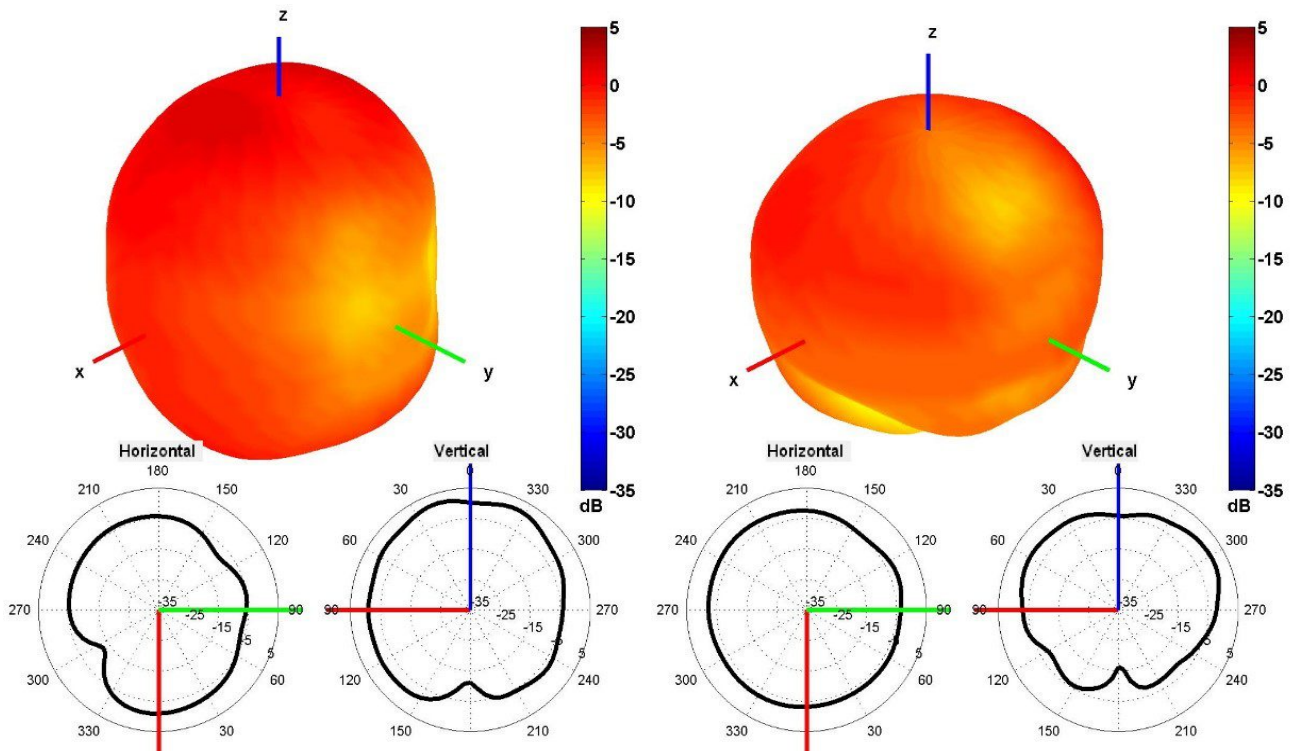

2100 and 2600 MHz Radiation pattern

4. Antenna drawings

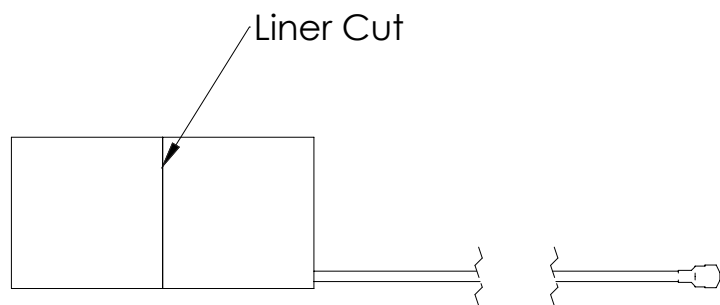
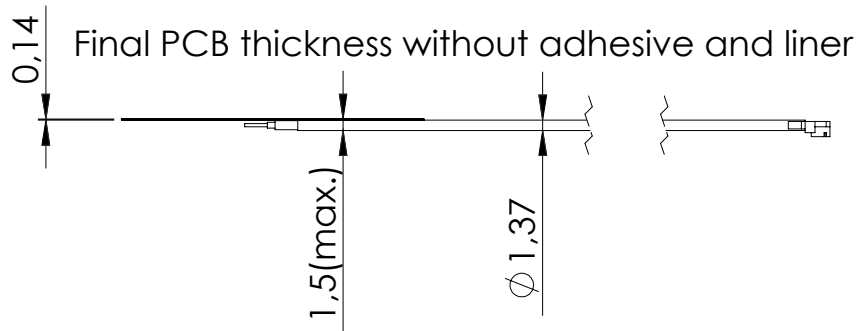
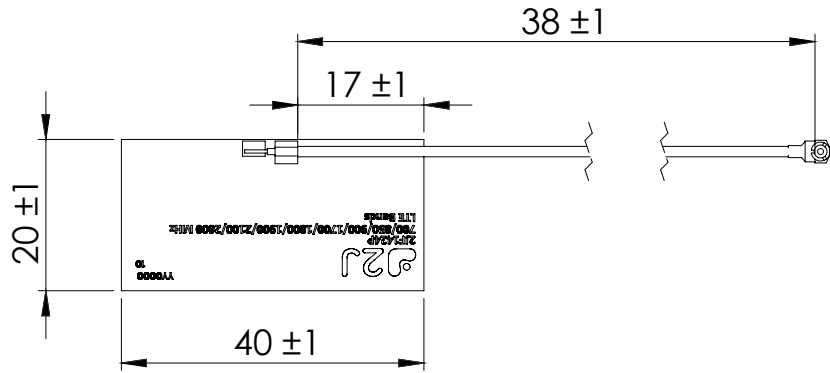

5. Application Note

2JF1424P and 2JF1424Pa

1./ INTRODUCTION

The "Mono-Flexi" Series of high efficiency antennas introduce a new cable bridging between radiation elements and ground plane extension, making it ideal for small device integration into PCB or cellular devices with complicated size restrictions. This creates a lower resonance and optimizes tuning while keeping the antenna dimensions to a minimum with maximum efficiency, especially across low frequency bands.

Some common applications for this antenna are: Cellular Mobile HD4K Video, Consumer Electronics, Laptops / Tablets, Drones, Small OBDII Tracking Systems, etc.

2JF1424P and 2JF1424Pa are compatible with 4G LTE, 3G and 2G standards, covering 698 MHz – 2700 MHz frequencies. With peak gains up to ~4.1 dBi, this antenna maintains excellent maximum efficiency of ~70% while offering constant reliable connectivity. This antenna is the newest solution for high voice, data, and internet connectivity necessary for IoT and device to device quality communications.

2./ ANTENNA SELECTION, LOCATION AND ORIENTATION

Depending on the module model and location on the device's PCB, the Left-Handed Feed, or the Right-Handed Feed Antenna (2JF1424P and 2JF1424Pa respectively) should be selected. This is to have the antenna connector closer to the module of the device. We must remember this antenna is different technology and long cable is not possible to use. The second consideration when selecting the antenna is: if the ground plane is of square form factor, we must position the antenna on the corner of the PCB and the cable routing must point outwards of the ground plane. This is to maximize the current distribution on the antenna and the patented bridging effect on the antenna. Antenna must be mounted on the shortest side of the board when rectangular, if squared, board must be at the corner. See below images.

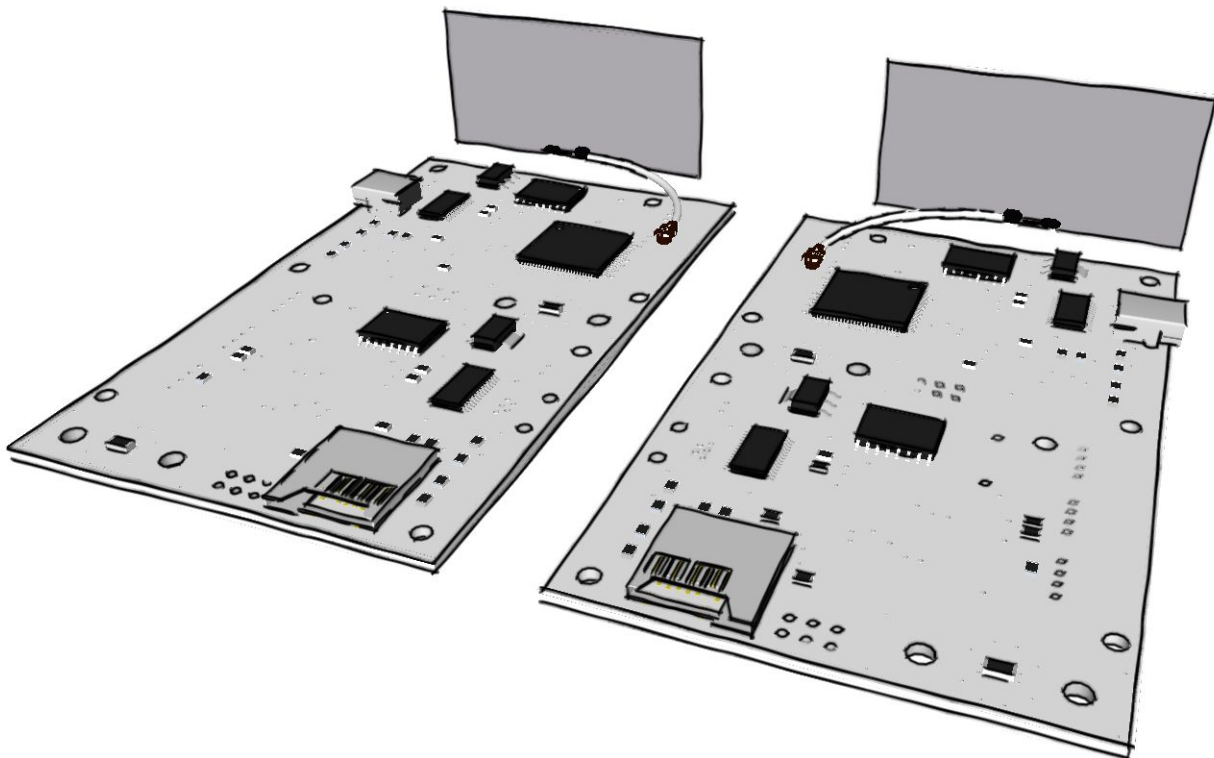

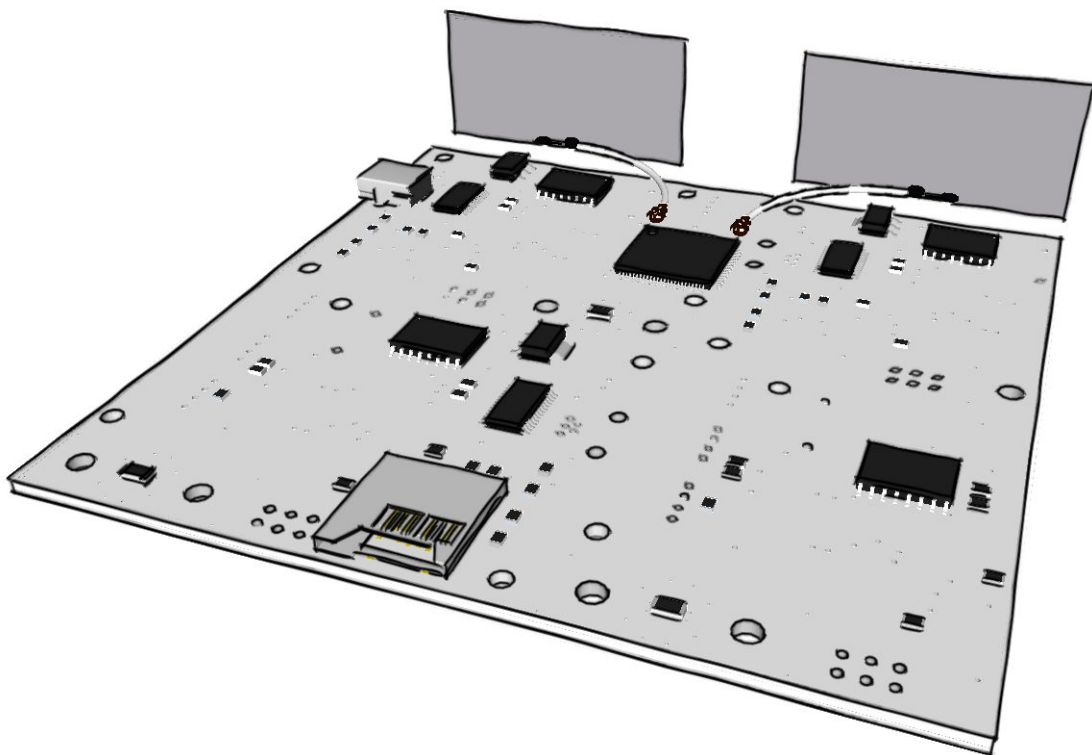
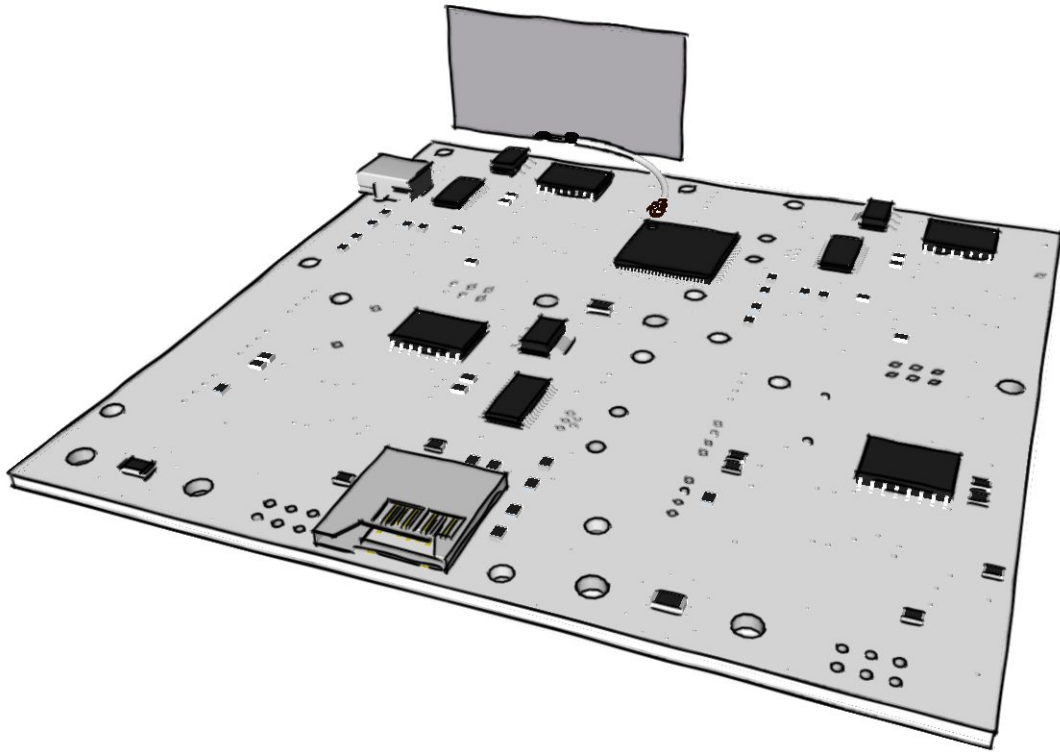

Avoid placing the antennas in front of high-profile metal elements or noisy components such as USB, LAN, power supplies, large inductors, RF connectors, etc. It is essential to keep 10mm distance from the antenna to the edge of the PCB for optimal performance, unless in case by case the distance to ground plane can be reduced to 7mm or increased it up to 15m. The basic rule of thumb for high profile metal objects is to be below the 30 degree line from the edge of the ground plane. See below images.

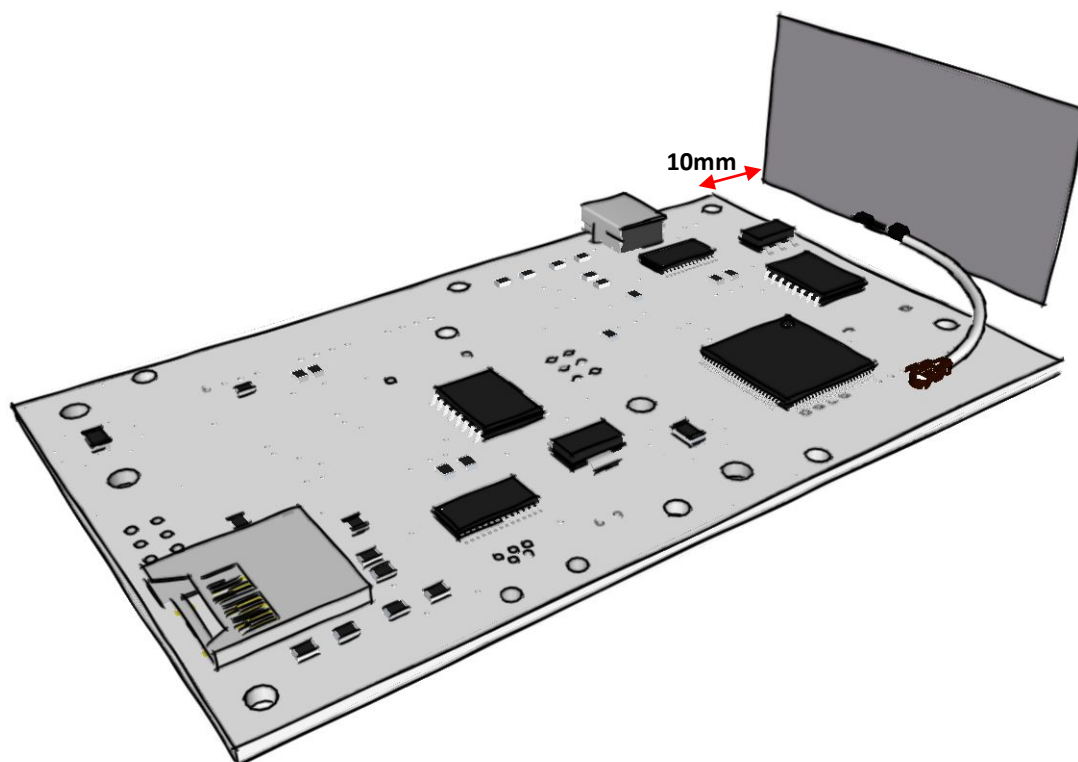
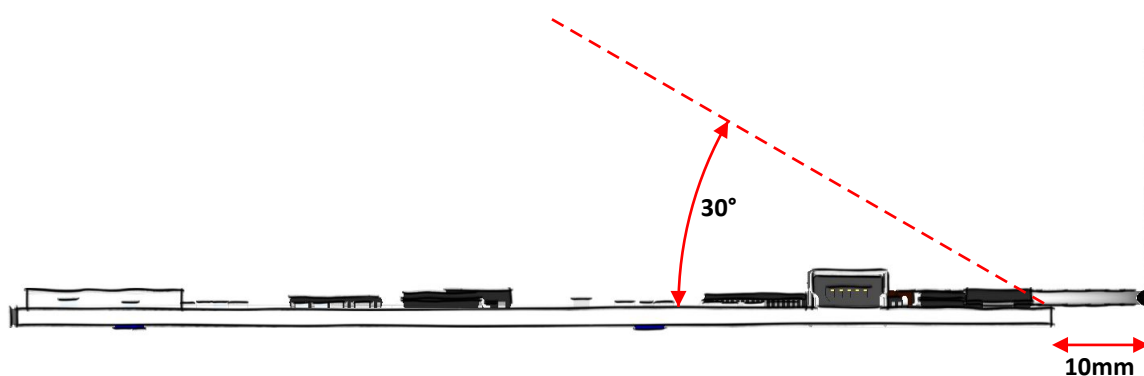

3./ MIMO AND ARRAY SYSTEM

When 2 or more antennas are used in an RF System/Solution, we need to follow certain guidelines to avoid auto-cancellation between the antennas, since each antenna is a resonating element radiating and trapping energy around, and when multiple antennas are collocated this can cause interference and auto-cancelling. We need to select the antennas in cross feed, for the Left Corner we need to install the Right-Handed Feed Antenna (2JF1424Pa) and for the Right Corner we need to install the Left-Handed Feed. The optimal distance between the antennas is 40 mm, can be reduced to 30mm and increase with no limit. Same logic applies when 4x4 Array is needed. Please see image below:

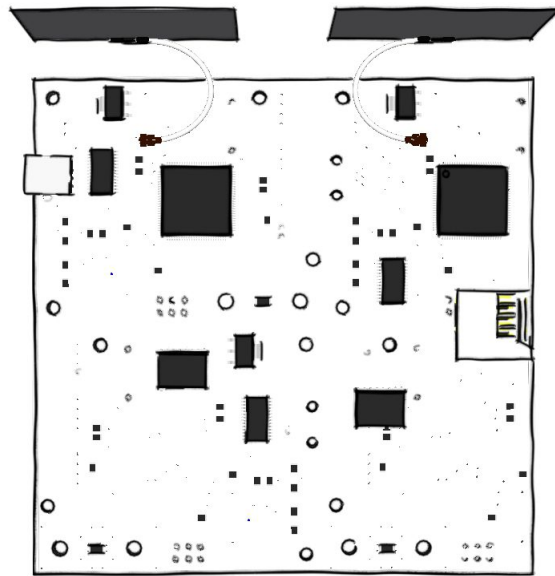

MIMO SYSTEM (Top view)

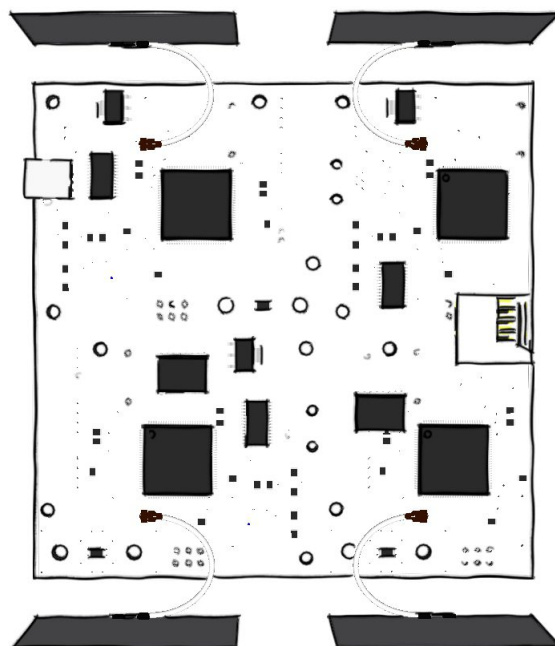

4x4 ARRAY (Top view)

4./ CABLE LENGTH AND ROUTING

Cable plays an important role on the proper functionality of the antenna, the optimal cable length is 38 mm but can be reduced to a minimum of 35mm and a maximum of 50mm, unfortunately this antenna cannot be used with a large RF cable, as the antenna technology embedded into the antenna will not function, and we lose the super high efficiency performance at the small size. The first recommended choice for cable routing is an Inverted L-Shape and second is the Inverted C-Shape; other shapes may be possible on case by case for fine tuning, but the first 2 options should cover the majority of needs. The RF Cable resolution is in 1mm increment for ordering, with +/- 1 mm of tolerance.

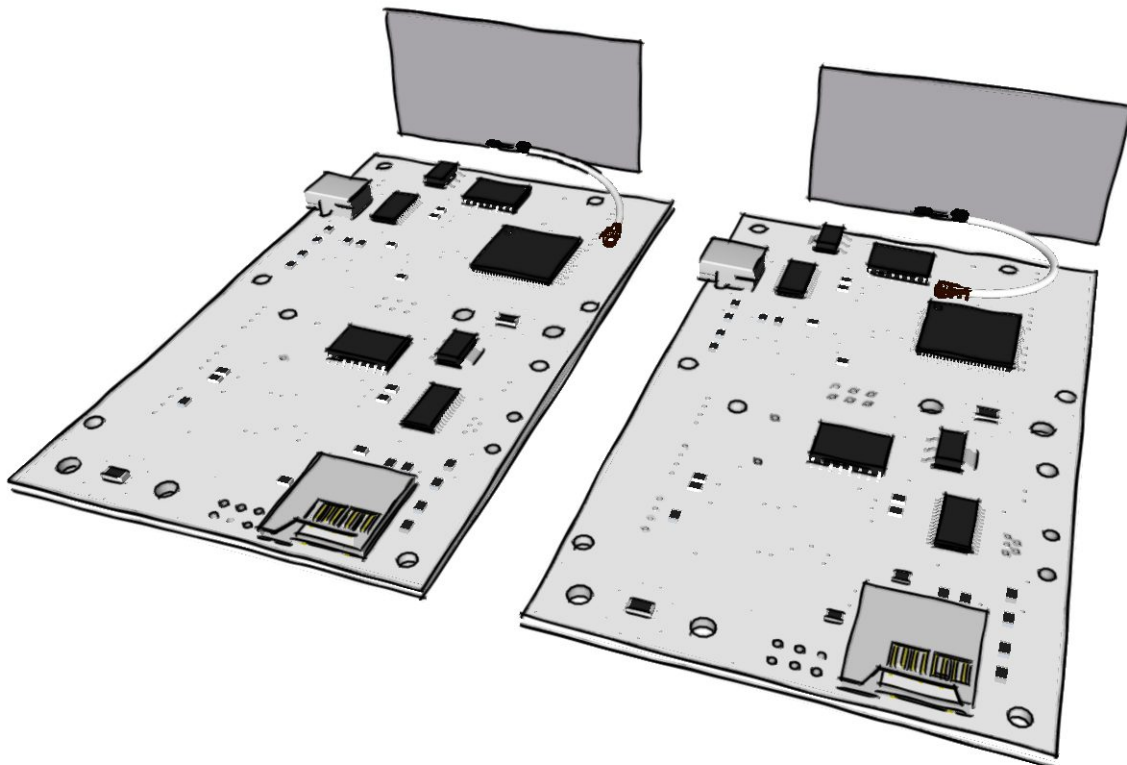

5./ RECOMMENDED MATCHING NETWORK

The starting point is to add a zero ohm resistor on the series component. Most of the cases will not need matching components, but is recommend to add the below network spaces in the case is needed, for a later fine tuning or a filter for spurious emissions if applies. Please use 0402 components size, ideal for RF applications.

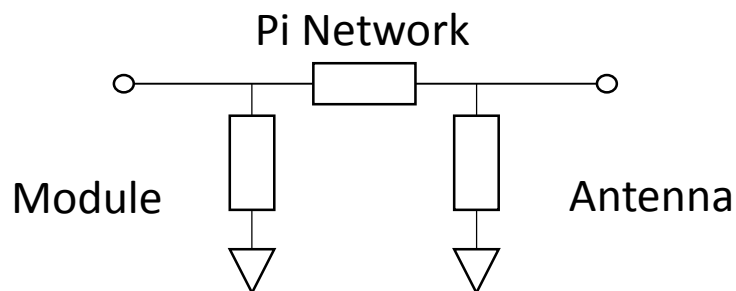

6./ RECOMMENDED TRANSMISSION LINE

For RF devices, 4 or more PCB layers is essential and for better noise immunity we highly recommend the use of CPW-G (Co-Planar Waveguide Grounded) type of transmission line, please ensure during calculation, this is not confused with CPW (Not grounded) and keep in mind to have 3 times the width of the signal track the ground plane pours on each side; this to maintain good signal integrity (likewise for the others). In some cases, Microstrip transmission line can be selected but this introduces difficulties for the antenna grounding and for analysis of the integration measurement in the chamber. The third and more specific configuration is the Strip Line. This kind of transmission line is more common on GNSS applications where the TX line must be inside the PCB ground planes to protect the signal from outside and surface noise.

This transmission line is more specific and difficult to integrate since it may require more PCB layers. Typically, this Tx line is found in cell phone design due to is noise quieting. See images below:

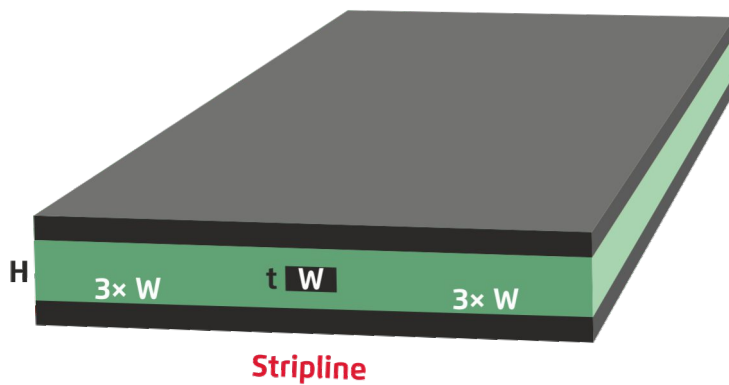
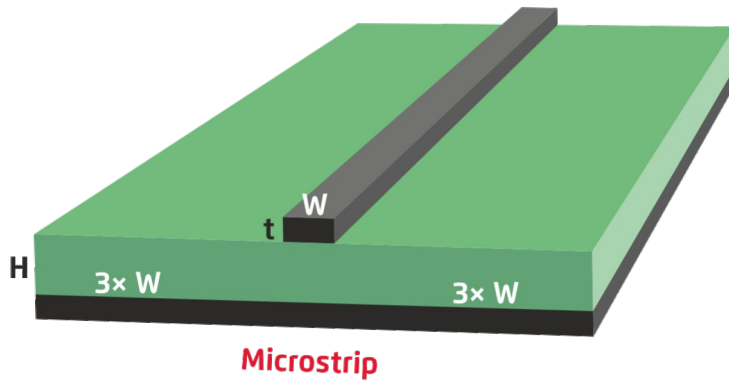
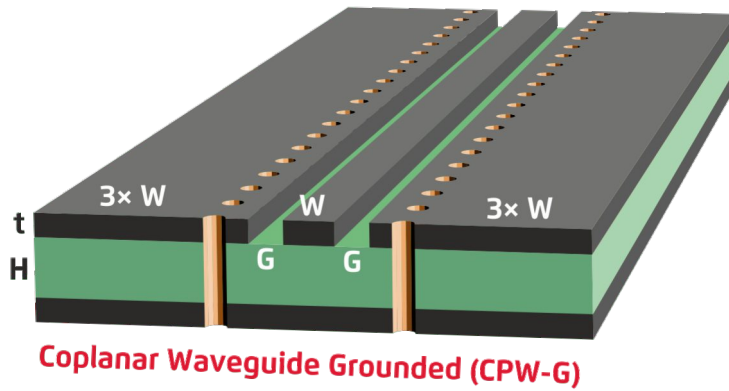

7./ GROUND PLANE VS EFFICIENCY

The below test data shows the performance at different ground plane lengths, across the entire 4GLTE/3G/2G spectrum from 698-960, 1710-2700 MHz. The antenna parameters presented are efficiency, peak gain, and average gain, and this will help to estimate the minimum ground plane needed to pass specific certifications around the world, we measure from optimal ground plane to the minimum possible (from 110 to 40 mm.)

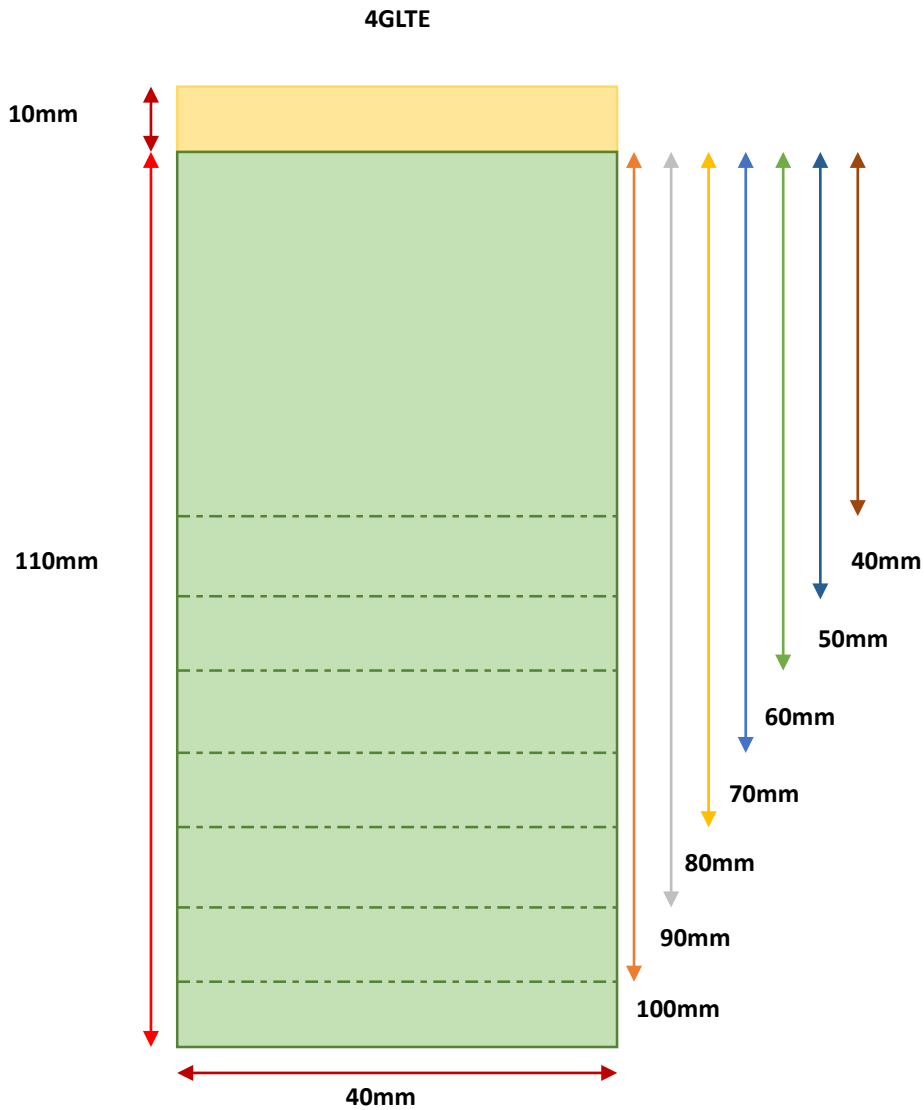

— 2JF1424P-110mm
 — 2JF1424P-100mm
 — 2JF1424P-90mm
 — 2JF1424P-80mm
— 2JF1424P-70mm
 — 2JF1424P-60mm
 — 2JF1424P-50mm
 — 2JF1424P-40mm

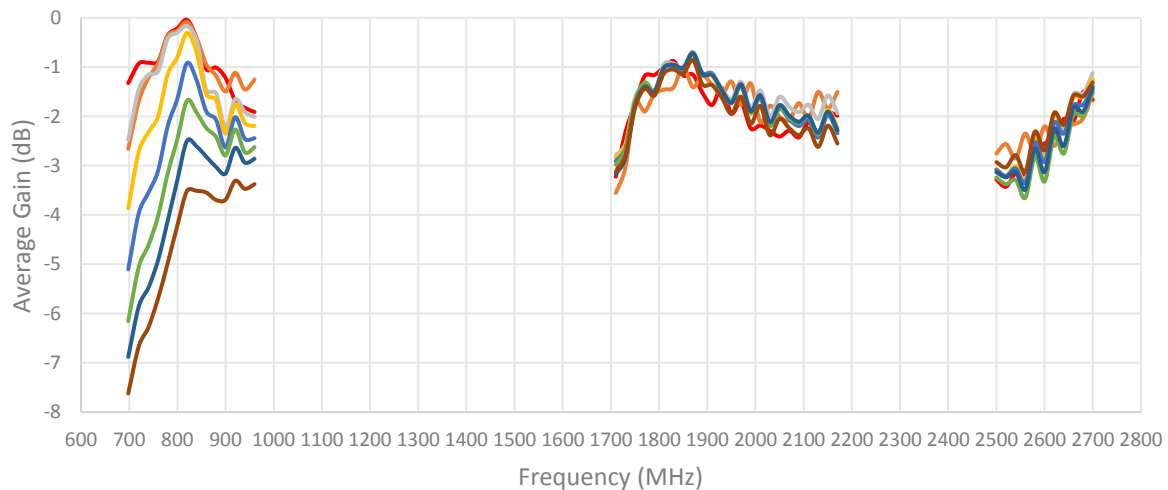
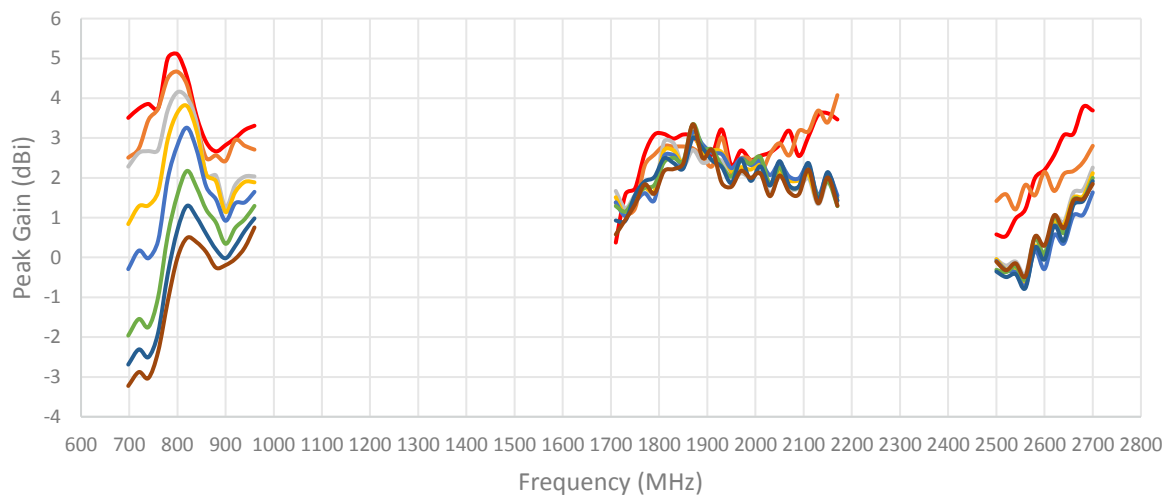
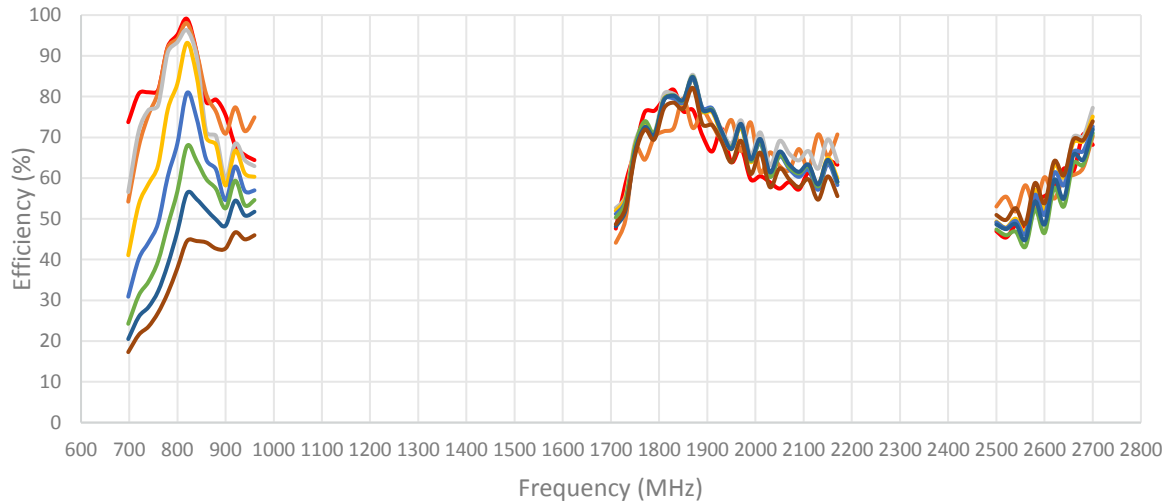

8./ PROHIBITED IMPLEMENTATIONS

- ☒ We cannot utilize this antenna with long RF cable.
- ☒ Cable routing is important, like recommended above.
- ☒ We need to keep minimal distance from PCB ground plane edge.
- ☒ Antenna must be orthogonal to PCB (can be flushed with PCB but still requires distance from PCB ground plane edge).
- ☒ Antenna cannot be mounted above and inside the boundaries of PCB ground plane.
- ☒ Antenna cannot be mounted parallel and inside the boundaries of PCB ground plane.
- ☒ Ground plane edge must be in straight line along the whole PCB edge, where the antenna is mounted, called the prohibited area.
- ☒ On said prohibited area we cannot have ground plane pours, traces, electronic components, etc.
- ☒ Keep clean the entire prohibited area along the whole edge.

6. Antenna Images

