

Data sheet | Item number: 769-219/281-413

1-conductor/1-pin component carrier terminal block; with 2 jumper positions; LED (red); 24 VDC; for DIN-rail 35 x 15 and 35 x 7.5; 4 mm²; CAGE CLAMP®; 4,00 mm²; gray

www.wago.com/769-219_281-413

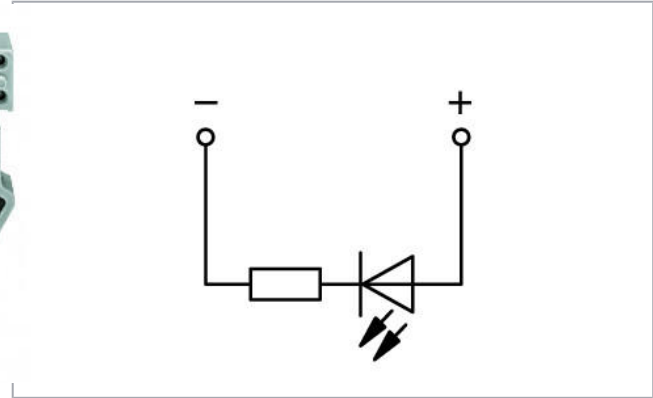
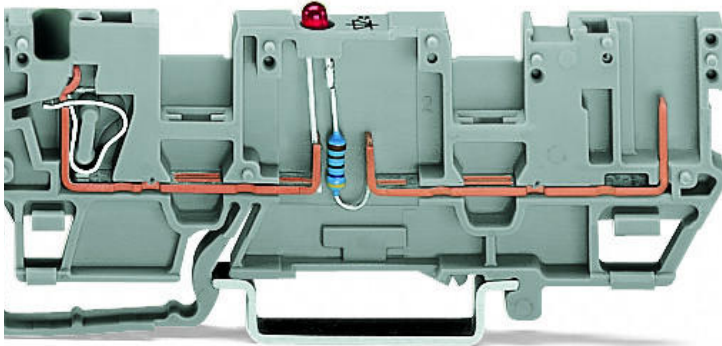

 Picture differs from the item.

RoHS 
Compliant

[BOMcheck.net](https://www.bomcheck.net)

Color: 

Data

Electrical data

Voltage type 1	DC
Nominal voltage	24 V

Ratings per IEC/EN

Rated current	0.025 A
---------------	---------

Connection data

Connection technology	CAGE CLAMP®
Actuation type	Open Tool Slot
Connectable conductor materials	Copper
Nominal cross-section	4 mm ²
Solid conductor	0.08 ... 4 mm ² / 28 ... 12 AWG
Fine-stranded conductor	0.08 ... 4 mm ² / 28 ... 12 AWG

Subject to changes. Please also observe the further product documentation!

WAGO Kontakttechnik GmbH & Co. KG
Hansastr. 27
32423 Minden
Phone: +49571 887-0 | Fax: +49571 887-169
Email: info.de@wago.com | Web: www.wago.com

Do you have any questions about our products?
We are always happy to take your call at +49 (571) 887-44222.



Strip length	8 ... 9 mm / 0.31 ... 0.35 inch
Total number of connection points	1
Total number of potentials	1
Number of levels	1
Wiring type	Front-entry wiring

Physical data

Width	5 mm / 0.197 inch
Height	87.5 mm / 3.445 inch

Mechanical data

Design	horizontal type
Mounting type	DIN-35 rail
Marking level	Center marking

Material data

Color	gray
Insulation material	Polyamide (PA66)
Fire load	0.161 MJ
Weight	8.2 g

Commercial data

Product Group	18 (X-COM-System)
Packaging type	BOX
Country of origin	DE
GTIN	4050821418504
Customs tariff number	85369010000

Approvals / Certificates

Country specific Approvals

Logo	Approval	Additional Approval Text	Certificate name
	CCA DEKRA Certification B.V.	EN 60947	NTR NL-7626
	CSA	C22.2 No. 158	1101144

Subject to changes. Please also observe the further product documentation!

WAGO Kontakttechnik GmbH & Co. KG
 Hansastr. 27
 32423 Minden
 Phone: +49571 887-0 | Fax: +49571 887-169
 Email: info.de@wago.com | Web: www.wago.com

Do you have any questions about our products?
 We are always happy to take your call at +49 (571) 887-44222.



DEKRA Certification B.V.





KEMA/KEUR

DEKRA Certification B.V.

EN 60947



2190419.01

Ship Approvals

Logo	Approval	Additional Approval Text	Certificate name
	ABS American Bureau of Shipping	EN 60947	20- HG1941090- PDA
	DNV GL Det Norske Veritas, Germanischer Lloyd	-	TAE00001V2





Required accessories

End plate

	Item no.: 769-311 End and intermediate plate; 1.1 mm thick; gray	www.wago.com/769-311
	Item no.: 769-312 End and intermediate plate; 1.1 mm thick; orange	www.wago.com/769-312

Compatible products

assembling

	Item no.: 209-106 Mounting carrier; for isolated mounting on DIN 35 rails; gray	www.wago.com/209-106
	Item no.: 249-116 Screwless end stop; 6 mm wide; for DIN-rail 35 x 15 and 35 x 7.5; gray	www.wago.com/249-116
Push-In type wire jumper		
	Item no.: 249-123 Push-in type wire jumper; 0.75 mm ² ; insulated; 180 mm long; black	www.wago.com/249-123
	Item no.: 249-125 Push-in type wire jumper; insulated; 60 mm long; black	www.wago.com/249-125

Subject to changes. Please also observe the further product documentation!



Item no.: 249-126
Push-in type wire jumper; 0.75 mm²; insulated; 110 mm long; black

www.wago.com/249-126



Item no.: 249-127
Push-in type wire jumper; 0.75 mm²; insulated; 250 mm long; black

www.wago.com/249-127

ferrule



Item no.: 216-101
Ferrule; Sleeve for 0.5 mm² / AWG 22; uninsulated; electro-tin plated; silver-colored

www.wago.com/216-101



Item no.: 216-102
Ferrule; Sleeve for 0.75 mm² / AWG 20; uninsulated; electro-tin plated; silver-colored

www.wago.com/216-102



Item no.: 216-103
Ferrule; Sleeve for 1 mm² / AWG 18; uninsulated; electro-tin plated

www.wago.com/216-103



Item no.: 216-104
Ferrule; Sleeve for 1.5 mm² / AWG 16; uninsulated; electro-tin plated; silver-colored

www.wago.com/216-104



Item no.: 216-201
Ferrule; Sleeve for 0.5 mm² / 20 AWG; insulated; electro-tin plated; white

www.wago.com/216-201



Item no.: 216-202
Ferrule; Sleeve for 0.75 mm² / 18 AWG; insulated; electro-tin plated; gray

www.wago.com/216-202



Item no.: 216-203
Ferrule; Sleeve for 1 mm² / AWG 18; insulated; electro-tin plated; red

www.wago.com/216-203



Item no.: 216-204
Ferrule; Sleeve for 1.5 mm² / AWG 16; insulated; electro-tin plated; black

www.wago.com/216-204



Item no.: 216-206
Ferrule; Sleeve for 2.5 mm² / AWG 14; insulated; electro-tin plated; blue

www.wago.com/216-206

Item no.: 216-301
Ferrule; Sleeve for 0.25 mm² / AWG 24; insulated; electro-tin plated; yellow

www.wago.com/216-301



Item no.: 216-302
Ferrule; Sleeve for 0.34 mm² / 22 AWG; insulated; electro-tin plated; green

www.wago.com/216-302

check



Item no.: 210-136
Test plug; 2 mm Ø; with 500 mm cable; red

www.wago.com/210-136



Item no.: 210-137
Test plug; 2.3 mm Ø; with 500 mm cable; yellow

www.wago.com/210-137



Item no.: 280-404
Test plug adapter; 5 mm wide; for test plug (2.3 mm Ø); suitable for 1.5 mm² - 4 mm² tbs; gray

www.wago.com/280-404



Item no.: 280-418
Test plug module; modular; suitable for all WAGO 280 and 780 Series rail-mounted terminal blocks with jumper slots in the current bar; gray

www.wago.com/280-418

Subject to changes. Please also observe the further product documentation!





Item no.: 280-419
Spacer module; modular; bridging commoned terminal blocks; gray

www.wago.com/280-419

Carrier rail

	Item no.: 210-112 Steel carrier rail; 35 x 7.5 mm; 1 mm thick; 2 m long; slotted; according to EN 60715; "Hole width 25 mm; silver-colored	www.wago.com/210-112
	Item no.: 210-113 Steel carrier rail; 35 x 7.5 mm; 1 mm thick; 2 m long; unslotted; according to EN 60715; silver-colored	www.wago.com/210-113
	Item no.: 210-114 Steel carrier rail; 35 x 15 mm; 1.5 mm thick; 2 m long; unslotted; similar to EN 60715; silver-colored	www.wago.com/210-114
	Item no.: 210-115 Steel carrier rail; 35 x 7.5 mm; 1 mm thick; 2 m long; slotted; according to EN 60715; "Hole width 18 mm; silver-colored	www.wago.com/210-115
	Item no.: 210-118 Steel carrier rail; 35 x 15 mm; 2.3 mm thick; 2 m long; unslotted; according to EN 60715; silver-colored	www.wago.com/210-118
	Item no.: 210-196 Aluminum carrier rail; 35 x 8.2 mm; 1.6 mm thick; 2 m long; unslotted; similar to EN 60715; silver-colored	www.wago.com/210-196
	Item no.: 210-197 Steel carrier rail; 35 x 15 mm; 1.5 mm thick; 2 m long; slotted; similar to EN 60715; silver-colored	www.wago.com/210-197
	Item no.: 210-198 Copper carrier rail; 35 x 15 mm; 2.3 mm thick; 2 m long; unslotted; according to EN 60715; copper-colored	www.wago.com/210-198
	Item no.: 210-504 Steel carrier rail; 35 x 7.5 mm; 1 mm thick; 2 m long; slotted; galvanized; according to EN 60715; silver-colored	www.wago.com/210-504
	Item no.: 210-505 Steel carrier rail; 35 x 7.5 mm; 1 mm thick; 2 m long; unslotted; galvanized; according to EN 60715; silver-colored	www.wago.com/210-505
	Item no.: 210-506 Steel carrier rail; 35 x 15 mm; 1.5 mm thick; 2 m long; unslotted; galvanized; similar to EN 60715; silver-colored	www.wago.com/210-506
	Item no.: 210-508 Steel carrier rail; 35 x 15 mm; 1.5 mm thick; 2 m long; slotted; galvanized; similar to EN 60715; silver-colored	www.wago.com/210-508

Insulation stop

	Item no.: 769-470 Insulation stop; 0.08 - 0.2 mm ² "s" (0.14 mm ² "f-st"); 5 pieces/strip; white	www.wago.com/769-470
	Item no.: 769-471 Insulation stop; 0.25 - 0.5 mm ² ; 5 pieces/strip; light gray	www.wago.com/769-471
	Item no.: 769-472 Insulation stop; 0.75 - 1 mm ² ; 5 pieces/strip; dark gray	www.wago.com/769-472

tools

Subject to changes. Please also observe the further product documentation!



Item no.: 210-720
Operating tool; Blade: 3.5 x 0.5 mm; with a partially insulated shaft; multicoloured

www.wago.com/210-720

Coding



Item no.: 769-435
Coding pin; for coding of female plugs; for carrier terminal blocks / male connectors; orange

www.wago.com/769-435

End plate



Item no.: 769-314
Separator plate; 1.1 mm thick; oversized; orange

www.wago.com/769-314

protection



Item no.: 769-438
Pin cover; with marker slot for miniature WSB; gray

www.wago.com/769-438



Item no.: 769-439
Pin cover; with marker slot for miniature WSB; orange

www.wago.com/769-439

Jumper



Item no.: 280-402
Jumper; insulated; gray

www.wago.com/280-402



Item no.: 280-409
Jumper; insulated; gray

www.wago.com/280-409



Item no.: 780-452
Staggered jumper; from 1 to 2; insulated; gray

www.wago.com/780-452



Item no.: 780-453
Staggered jumper; from 1 to 3; insulated; gray

www.wago.com/780-453



Item no.: 780-454
Staggered jumper; from 1 to 4; insulated; gray

www.wago.com/780-454



Item no.: 780-455
Staggered jumper; from 1 to 5; insulated; gray

www.wago.com/780-455



Item no.: 780-456
Staggered jumper; from 1 to 6; insulated; gray

www.wago.com/780-456



Item no.: 780-457
Staggered jumper; from 1 to 7; insulated; gray

www.wago.com/780-457



Item no.: 780-458
Staggered jumper; from 1 to 8; insulated; gray

www.wago.com/780-458

Female plug



Item no.: 769-101
1-conductor female plug; 4 mm²; 1-pole; 4,00 mm²; gray















www.wago.com/769-101



Item no.: 769-101/000-006
1-conductor female plug; 4 mm²; 1-pole; 4,00 mm²; blue

www.wago.com/769-101/000-006

Subject to changes. Please also observe the further product documentation!

	Item no.: 769-101/000-016 1-conductor female plug; 4 mm ² ; 1-pole; 4,00 mm ² ; green-yellow	www.wago.com/769-101/000-016
	Item no.: 769-101/022-000 1-conductor female plug; angled; 4 mm ² ; 1-pole; 4,00 mm ² ; gray	www.wago.com/769-101/022-000
	Item no.: 769-101/022-016 1-conductor female plug; angled; 4 mm ² ; 1-pole; 4,00 mm ² ; green-yellow	www.wago.com/769-101/022-016
	Item no.: 769-102 1-conductor female plug; 4 mm ² ; 2-pole; 4,00 mm ² ; gray	www.wago.com/769-102
	Item no.: 769-102/000-006 1-conductor female plug; 4 mm ² ; 2-pole; 4,00 mm ² ; blue	www.wago.com/769-102/000-006
	Item no.: 769-102/000-036 1-conductor female plug; 4 mm ² ; 2-pole; 4,00 mm ² ; gray, green-yellow	www.wago.com/769-102/000-036
	Item no.: 769-102/000-037 1-conductor female plug; 4 mm ² ; 2-pole; 4,00 mm ² ; green-yellow, gray	www.wago.com/769-102/000-037
	Item no.: 769-102/022-000 1-conductor female plug; angled; 4 mm ² ; 2-pole; 4,00 mm ² ; gray	www.wago.com/769-102/022-000
	Item no.: 769-103 1-conductor female plug; 4 mm ² ; 3-pole; 4,00 mm ² ; gray	www.wago.com/769-103
	Item no.: 769-103/000-006 1-conductor female plug; 4 mm ² ; 3-pole; 4,00 mm ² ; blue	www.wago.com/769-103/000-006
	Item no.: 769-103/000-036 1-conductor female plug; 4 mm ² ; 3-pole; 4,00 mm ² ; gray, green-yellow	www.wago.com/769-103/000-036
	Item no.: 769-103/000-037 1-conductor female plug; 4 mm ² ; 3-pole; 4,00 mm ² ; green-yellow, gray	www.wago.com/769-103/000-037
	Item no.: 769-103/000-038 1-conductor female plug; 4 mm ² ; 3-pole; 4,00 mm ² ; gray, blue, green-yellow	www.wago.com/769-103/000-038
	Item no.: 769-103/000-039 1-conductor female plug; 4 mm ² ; 3-pole; 4,00 mm ² ; green-yellow, blue, gray	www.wago.com/769-103/000-039

Subject to changes. Please also observe the further product documentation!



Item no.: 769-103/022-000
1-conductor female plug; angled; 4 mm²; 3-pole; 4,00 mm²; gray

www.wago.com/769-103/022-000



Item no.: 769-104
1-conductor female plug; 4 mm²; 4-pole; 4,00 mm²; gray

www.wago.com/769-104



Item no.: 769-104/000-006
1-conductor female plug; 4 mm²; 4-pole; 4,00 mm²; blue

www.wago.com/769-104/000-006



Item no.: 769-104/000-036
1-conductor female plug; 4 mm²; 4-pole; 4,00 mm²; gray, green-yellow

www.wago.com/769-104/000-036



Item no.: 769-104/000-037
1-conductor female plug; 4 mm²; 4-pole; 4,00 mm²; green-yellow, gray

www.wago.com/769-104/000-037



Item no.: 769-104/000-038
1-conductor female plug; 4 mm²; 4-pole; 4,00 mm²; gray, blue, green-yellow

www.wago.com/769-104/000-038



Item no.: 769-104/000-039
1-conductor female plug; 4 mm²; 4-pole; 4,00 mm²; green-yellow, blue, gray

www.wago.com/769-104/000-039



Item no.: 769-104/022-000
1-conductor female plug; angled; 4 mm²; 4-pole; 4,00 mm²; gray

www.wago.com/769-104/022-000



Item no.: 769-105
1-conductor female plug; 4 mm²; 5-pole; 4,00 mm²; gray

www.wago.com/769-105



Item no.: 769-105/000-006
1-conductor female plug; 4 mm²; 5-pole; 4,00 mm²; blue

www.wago.com/769-105/000-006



Item no.: 769-105/000-036
1-conductor female plug; 4 mm²; 5-pole; 4,00 mm²; gray, green-yellow

www.wago.com/769-105/000-036



Item no.: 769-105/000-037
1-conductor female plug; 4 mm²; 5-pole; 4,00 mm²; green-yellow, gray

www.wago.com/769-105/000-037



Item no.: 769-105/000-038
1-conductor female plug; 4 mm²; 5-pole; 4,00 mm²; gray, blue, green-yellow

www.wago.com/769-105/000-038



Item no.: 769-105/000-039
1-conductor female plug; 4 mm²; 5-pole; 4,00 mm²; green-yellow, blue, gray

www.wago.com/769-105/000-039

Subject to changes. Please also observe the further product documentation!



Item no.: 769-105/022-000
1-conductor female plug; angled; 4 mm²; 5-pole; 4,00 mm²; gray

www.wago.com/769-105/022-000



Item no.: 769-106
1-conductor female plug; 4 mm²; 6-pole; 4,00 mm²; gray

www.wago.com/769-106



Item no.: 769-106/000-006
1-conductor female plug; 4 mm²; 6-pole; 4,00 mm²; blue

www.wago.com/769-106/000-006



Item no.: 769-106/000-036
1-conductor female plug; 4 mm²; 6-pole; 4,00 mm²; gray, green-yellow

www.wago.com/769-106/000-036



Item no.: 769-106/000-037
1-conductor female plug; 4 mm²; 6-pole; 4,00 mm²; green-yellow, gray

www.wago.com/769-106/000-037



Item no.: 769-106/000-038
1-conductor female plug; 4 mm²; 6-pole; 4,00 mm²; gray, blue, green-yellow

www.wago.com/769-106/000-038



Item no.: 769-106/000-039
1-conductor female plug; 4 mm²; 6-pole; 4,00 mm²; green-yellow, blue, gray

www.wago.com/769-106/000-039



Item no.: 769-106/022-000
1-conductor female plug; angled; 4 mm²; 6-pole; 4,00 mm²; gray

www.wago.com/769-106/022-000



Item no.: 769-107
1-conductor female plug; 4 mm²; 7-pole; 4,00 mm²; gray

www.wago.com/769-107



Item no.: 769-107/000-006
1-conductor female plug; 4 mm²; 7-pole; 4,00 mm²; blue

www.wago.com/769-107/000-006



Item no.: 769-107/000-036
1-conductor female plug; 4 mm²; 7-pole; 4,00 mm²; gray, green-yellow

www.wago.com/769-107/000-036



Item no.: 769-107/000-037
1-conductor female plug; 4 mm²; 7-pole; 4,00 mm²; green-yellow, gray

www.wago.com/769-107/000-037



Item no.: 769-107/000-038
1-conductor female plug; 4 mm²; 7-pole; 4,00 mm²; gray, blue, green-yellow

www.wago.com/769-107/000-038



Item no.: 769-107/000-039
1-conductor female plug; 4 mm²; 7-pole; 4,00 mm²; green-yellow, blue, gray

www.wago.com/769-107/000-039

Subject to changes. Please also observe the further product documentation!



Item no.: 769-107/022-000
1-conductor female plug; angled; 4 mm²; 7-pole; 4,00 mm²; gray

www.wago.com/769-107/022-000



Item no.: 769-108
1-conductor female plug; 4 mm²; 8-pole; 4,00 mm²; gray

www.wago.com/769-108



Item no.: 769-108/000-006
1-conductor female plug; 4 mm²; 8-pole; 4,00 mm²; blue

www.wago.com/769-108/000-006



Item no.: 769-108/000-036
1-conductor female plug; 4 mm²; 8-pole; 4,00 mm²; gray, green-yellow

www.wago.com/769-108/000-036



Item no.: 769-108/000-037
1-conductor female plug; 4 mm²; 8-pole; 4,00 mm²; green-yellow, gray

www.wago.com/769-108/000-037



Item no.: 769-108/000-038
1-conductor female plug; 4 mm²; 8-pole; 4,00 mm²; gray, blue, green-yellow

www.wago.com/769-108/000-038



Item no.: 769-108/000-039
1-conductor female plug; 4 mm²; 8-pole; 4,00 mm²; green-yellow, blue, gray

www.wago.com/769-108/000-039



Item no.: 769-108/022-000
1-conductor female plug; angled; 4 mm²; 8-pole; 4,00 mm²; gray

www.wago.com/769-108/022-000



Item no.: 769-109
1-conductor female plug; 4 mm²; 9-pole; 4,00 mm²; gray

www.wago.com/769-109



Item no.: 769-109/000-006
1-conductor female plug; 4 mm²; 9-pole; 4,00 mm²; blue

www.wago.com/769-109/000-006



Item no.: 769-109/000-036
1-conductor female plug; 4 mm²; 9-pole; 4,00 mm²; gray, green-yellow

www.wago.com/769-109/000-036



Item no.: 769-109/000-037
1-conductor female plug; 4 mm²; 9-pole; 4,00 mm²; green-yellow, gray

www.wago.com/769-109/000-037



Item no.: 769-109/000-038
1-conductor female plug; 4 mm²; 9-pole; 4,00 mm²; gray, blue, green-yellow

www.wago.com/769-109/000-038



Item no.: 769-109/000-039
1-conductor female plug; 4 mm²; 9-pole; 4,00 mm²; green-yellow, blue, gray

www.wago.com/769-109/000-039

Subject to changes. Please also observe the further product documentation!



Item no.: 769-109/022-000
1-conductor female plug; angled; 4 mm²; 9-pole; 4,00 mm²; gray

www.wago.com/769-109/022-000



Item no.: 769-110
1-conductor female plug; 4 mm²; 10-pole; 4,00 mm²; gray

www.wago.com/769-110



Item no.: 769-110/000-006
1-conductor female plug; 4 mm²; 10-pole; 4,00 mm²; blue

www.wago.com/769-110/000-006



Item no.: 769-110/000-036
1-conductor female plug; 4 mm²; 10-pole; 4,00 mm²; gray, green-yellow

www.wago.com/769-110/000-036



Item no.: 769-110/000-037
1-conductor female plug; 4 mm²; 10-pole; 4,00 mm²; green-yellow, gray

www.wago.com/769-110/000-037



Item no.: 769-110/000-038
1-conductor female plug; 4 mm²; 10-pole; 4,00 mm²; gray, blue, green-yellow

www.wago.com/769-110/000-038



Item no.: 769-110/000-039
1-conductor female plug; 4 mm²; 10-pole; 4,00 mm²; green-yellow, blue, gray

www.wago.com/769-110/000-039



Item no.: 769-110/022-000
1-conductor female plug; angled; 4 mm²; 10-pole; 4,00 mm²; gray

www.wago.com/769-110/022-000



Item no.: 769-111
1-conductor female plug; 4 mm²; 11-pole; 4,00 mm²; gray

www.wago.com/769-111



Item no.: 769-111/000-006
1-conductor female plug; 4 mm²; 11-pole; 4,00 mm²; blue

www.wago.com/769-111/000-006



Item no.: 769-111/000-036
1-conductor female plug; 4 mm²; 11-pole; 4,00 mm²; gray, green-yellow

www.wago.com/769-111/000-036



Item no.: 769-111/000-037
1-conductor female plug; 4 mm²; 11-pole; 4,00 mm²; green-yellow, gray

www.wago.com/769-111/000-037



Item no.: 769-111/000-038
1-conductor female plug; 4 mm²; 11-pole; 4,00 mm²; gray, blue, green-yellow















www.wago.com/769-111/000-038

















Item no.: 769-111/000-039
1-conductor female plug; 4 mm²; 11-pole; 4,00 mm²; green-yellow, blue, gray

www.wago.com/769-111/000-039

















Subject to changes. Please also observe the further product documentation!

	Item no.: 769-111/022-000 1-conductor female plug; angled; 4 mm²; 11-pole; 4,00 mm²; gray	www.wago.com/769-111/022-000
	Item no.: 769-112 1-conductor female plug; 4 mm²; 12-pole; 4,00 mm²; gray	www.wago.com/769-112
	Item no.: 769-112/000-006 1-conductor female plug; 4 mm²; 12-pole; 4,00 mm²; blue	www.wago.com/769-112/000-006
	Item no.: 769-112/000-036 1-conductor female plug; 4 mm²; 12-pole; 4,00 mm²; gray, green-yellow	www.wago.com/769-112/000-036
	Item no.: 769-112/000-037 1-conductor female plug; 4 mm²; 12-pole; 4,00 mm²; green-yellow, gray	www.wago.com/769-112/000-037
	Item no.: 769-112/000-038 1-conductor female plug; 4 mm²; 12-pole; 4,00 mm²; gray, blue, green-yellow	www.wago.com/769-112/000-038
	Item no.: 769-112/000-039 1-conductor female plug; 4 mm²; 12-pole; 4,00 mm²; green-yellow, blue, gray	www.wago.com/769-112/000-039
	Item no.: 769-112/022-000 1-conductor female plug; angled; 4 mm²; 12-pole; 4,00 mm²; gray	www.wago.com/769-112/022-000
	Item no.: 769-113 1-conductor female plug; 4 mm²; 13-pole; 4,00 mm²; gray	www.wago.com/769-113
	Item no.: 769-113/000-036 1-conductor female plug; 4 mm²; 13-pole; 4,00 mm²; gray, green-yellow	www.wago.com/769-113/000-036
	Item no.: 769-113/000-037 1-conductor female plug; 4 mm²; 13-pole; 4,00 mm²; green-yellow, gray	www.wago.com/769-113/000-037
	Item no.: 769-113/000-038 1-conductor female plug; 4 mm²; 13-pole; 4,00 mm²; gray, blue, green-yellow	www.wago.com/769-113/000-038
	Item no.: 769-113/000-039 1-conductor female plug; 4 mm²; 13-pole; 4,00 mm²; green-yellow, blue, gray	www.wago.com/769-113/000-039
	Item no.: 769-113/022-000 1-conductor female plug; angled; 4 mm²; 13-pole; 4,00 mm²; gray	www.wago.com/769-113/022-000





Subject to changes. Please also observe the further product documentation!

	Item no.: 769-114 1-conductor female plug; 4 mm ² ; 14-pole; 4,00 mm ² ; gray	www.wago.com/769-114
	Item no.: 769-114/000-006 1-conductor female plug; 4 mm ² ; 14-pole; 4,00 mm ² ; blue	www.wago.com/769-114/000-006
	Item no.: 769-114/000-036 1-conductor female plug; 4 mm ² ; 14-pole; 4,00 mm ² ; gray, green-yellow	www.wago.com/769-114/000-036
	Item no.: 769-114/000-037 1-conductor female plug; 4 mm ² ; 14-pole; 4,00 mm ² ; green-yellow, gray	www.wago.com/769-114/000-037
	Item no.: 769-114/000-038 1-conductor female plug; 4 mm ² ; 14-pole; 4,00 mm ² ; gray, blue, green-yellow	www.wago.com/769-114/000-038
	Item no.: 769-114/000-039 1-conductor female plug; 4 mm ² ; 14-pole; 4,00 mm ² ; green-yellow, blue, gray	www.wago.com/769-114/000-039
	Item no.: 769-114/022-000 1-conductor female plug; angled; 4 mm ² ; 14-pole; 4,00 mm ² ; gray	www.wago.com/769-114/022-000
	Item no.: 769-115 1-conductor female plug; 4 mm ² ; 15-pole; 4,00 mm ² ; gray	www.wago.com/769-115
	Item no.: 769-115/000-036 1-conductor female plug; 4 mm ² ; 15-pole; 4,00 mm ² ; gray, green-yellow	www.wago.com/769-115/000-036
	Item no.: 769-115/000-037 1-conductor female plug; 4 mm ² ; 15-pole; 4,00 mm ² ; green-yellow, gray	www.wago.com/769-115/000-037
	Item no.: 769-115/000-038 1-conductor female plug; 4 mm ² ; 15-pole; 4,00 mm ² ; gray, blue, green-yellow	www.wago.com/769-115/000-038
	Item no.: 769-115/000-039 1-conductor female plug; 4 mm ² ; 15-pole; 4,00 mm ² ; green-yellow, blue, gray	www.wago.com/769-115/000-039
	Item no.: 769-115/022-000 1-conductor female plug; angled; 4 mm ² ; 15-pole; 4,00 mm ² ; gray	www.wago.com/769-115/022-000
	Item no.: 769-121 2-conductor female connector; 4 mm ² ; 1-pole; 4,00 mm ² ; gray	www.wago.com/769-121

Subject to changes. Please also observe the further product documentation!

	Item no.: 769-121/000-016 2-conductor female connector; 4 mm ² ; 1-pole; 4,00 mm ² ; green-yellow	www.wago.com/769-121/000-016
	Item no.: 769-122 2-conductor female connector; 4 mm ² ; 2-pole; 4,00 mm ² ; gray	www.wago.com/769-122
	Item no.: 769-123 2-conductor female connector; 4 mm ² ; 3-pole; 4,00 mm ² ; gray	www.wago.com/769-123
	Item no.: 769-124 2-conductor female connector; 4 mm ² ; 4-pole; 4,00 mm ² ; gray	www.wago.com/769-124
	Item no.: 769-125 2-conductor female connector; 4 mm ² ; 5-pole; 4,00 mm ² ; gray	www.wago.com/769-125
	Item no.: 769-126 2-conductor female connector; 4 mm ² ; 6-pole; 4,00 mm ² ; gray	www.wago.com/769-126
	Item no.: 769-127 2-conductor female connector; 4 mm ² ; 7-pole; 4,00 mm ² ; gray	www.wago.com/769-127
	Item no.: 769-128 2-conductor female connector; 4 mm ² ; 8-pole; 4,00 mm ² ; gray	www.wago.com/769-128
	Item no.: 769-129 2-conductor female connector; 4 mm ² ; 9-pole; 4,00 mm ² ; gray	www.wago.com/769-129
	Item no.: 769-130 2-conductor female connector; 4 mm ² ; 10-pole; 4,00 mm ² ; gray	www.wago.com/769-130
	Item no.: 769-131 2-conductor female connector; 4 mm ² ; 11-pole; 4,00 mm ² ; gray	www.wago.com/769-131
	Item no.: 769-132 2-conductor female connector; 4 mm ² ; 12-pole; 4,00 mm ² ; gray	www.wago.com/769-132
	Item no.: 769-133 2-conductor female connector; 4 mm ² ; 13-pole; 4,00 mm ² ; gray	www.wago.com/769-133
	Item no.: 769-134 2-conductor female connector; 4 mm ² ; 14-pole; 4,00 mm ² ; gray	www.wago.com/769-134
	Item no.: 769-135 2-conductor female connector; 4 mm ² ; 15-pole; 4,00 mm ² ; gray	www.wago.com/769-135
	Item no.: 769-501 Start module for 1-conductor female connector; with integrated end plate; 4 mm ² ; 1-pole; 4,00 mm ² ; gray	www.wago.com/769-501
	Item no.: 769-501/000-006 Start module for 1-conductor female connector; 4 mm ² ; 1-pole; 4,00 mm ² ; blue	www.wago.com/769-501/000-006

Subject to changes. Please also observe the further product documentation!

	<p>Item no.: 769-501/000-016 Start module for 1-conductor female connector; with integrated end plate; 4 mm²; 1-pole; 4,00 mm²; green-yellow</p>	www.wago.com/769-501/000-016
	<p>Item no.: 769-502 Center module for 1-conductor female connector; 4 mm²; 1-pole; 4,00 mm²; gray</p>	www.wago.com/769-502
	<p>Item no.: 769-502/000-006 Center module for 1-conductor female connector; 4 mm²; 1-pole; 4,00 mm²; blue</p>	www.wago.com/769-502/000-006
	<p>Item no.: 769-502/000-016 Center module for 1-conductor female connector; 4 mm²; 1-pole; 4,00 mm²; green-yellow</p>	www.wago.com/769-502/000-016
	<p>Item no.: 769-503 End module for 1-conductor female connector; 4 mm²; 1-pole; 4,00 mm²; gray</p>	www.wago.com/769-503
	<p>Item no.: 769-503/000-006 End module for 1-conductor female connector; 4 mm²; 1-pole; 4,00 mm²; blue</p>	www.wago.com/769-503/000-006
	<p>Item no.: 769-503/000-016 End module for 1-conductor female connector; 4 mm²; 1-pole; 4,00 mm²; green-yellow</p>	www.wago.com/769-503/000-016
	<p>Item no.: 769-504 Start module for 2-conductor female connector; with integrated end plate; 4 mm²; 1-pole; 4,00 mm²; gray</p>	www.wago.com/769-504
	<p>Item no.: 769-504/000-006 Start module for 2-conductor female connector; with integrated end plate; 4 mm²; 1-pole; 4,00 mm²; blue</p>	www.wago.com/769-504/000-006
	<p>Item no.: 769-504/000-016 Start module for 2-conductor female connector; 4 mm²; 1-pole; 4,00 mm²; green-yellow</p>	www.wago.com/769-504/000-016
	<p>Item no.: 769-505 Center module for 2-conductor female connector; 4 mm²; 1-pole; 4,00 mm²; gray</p>	www.wago.com/769-505
	<p>Item no.: 769-505/000-006 Center module for 2-conductor female connector; 4 mm²; 1-pole; 4,00 mm²; blue</p>	www.wago.com/769-505/000-006
	<p>Item no.: 769-505/000-016 Center module for 2-conductor female connector; 4 mm²; 1-pole; 4,00 mm²; green-yellow</p>	www.wago.com/769-505/000-016
	<p>Item no.: 769-506 End module for 2-conductor female connector; 4 mm²; 1-pole; 4,00 mm²; gray</p>	www.wago.com/769-506

Subject to changes. Please also observe the further product documentation!



Item no.: 769-506/000-006

End module for 2-conductor female connector; 4 mm²; 1-pole; 4,00 mm²; blue

www.wago.com/769-506/000-006



Item no.: 769-506/000-016

End module for 2-conductor female connector; 4 mm²; 1-pole; 4,00 mm²; green-yellow

www.wago.com/769-506/000-016



Item no.: 769-512

Start module for 1-conductor female connector; angled; 4 mm²; 1-pole; 4,00 mm²; gray

www.wago.com/769-512



Item no.: 769-512/000-006

Start module for 1-conductor female connector; angled; 4 mm²; 1-pole; 4,00 mm²; blue

www.wago.com/769-512/000-006



Item no.: 769-512/000-016

Start module for 1-conductor female connector; angled; 4 mm²; 1-pole; 4,00 mm²; green-yellow

www.wago.com/769-512/000-016



Item no.: 769-513

Center module for 1-conductor female connector; angled; 4 mm²; 1-pole; 4,00 mm²; gray

www.wago.com/769-513



Item no.: 769-513/000-006

Center module for 1-conductor female connector; angled; 4 mm²; 1-pole; 4,00 mm²; blue

www.wago.com/769-513/000-006



Item no.: 769-513/000-016

Center module for 1-conductor female connector; angled; 4 mm²; 1-pole; 4,00 mm²; green-yellow

www.wago.com/769-513/000-016



Item no.: 769-515

End module for 1-conductor female connector; angled; 4 mm²; 1-pole; 4,00 mm²; gray

www.wago.com/769-515



Item no.: 769-515/000-006

End module for 1-conductor female connector; angled; 4 mm²; 1-pole; 4,00 mm²; blue

www.wago.com/769-515/000-006



Item no.: 769-515/000-016

End module for 1-conductor female connector; angled; 4 mm²; 1-pole; 4,00 mm²; green-yellow

www.wago.com/769-515/000-016

Marking accessories



Item no.: 2009-145

Mini-WSB Inline; for Smart Printer; 1700 pieces on roll; stretchable 5 - 5.2 mm; plain; snap-on type; white

www.wago.com/2009-145



Item no.: 2009-145/000-002

Mini-WSB Inline; for Smart Printer; 1700 pieces on roll; stretchable 5 - 5.2 mm; plain; snap-on type; yellow

www.wago.com/2009-145/000-002



Item no.: 2009-145/000-005

Mini-WSB Inline; for Smart Printer; 1700 pieces on roll; stretchable 5 - 5.2 mm; plain; snap-on type; red

www.wago.com/2009-145/000-005

Subject to changes. Please also observe the further product documentation!

WAGO Kontakttechnik GmbH & Co. KG

Hansastr. 27















32423 Minden

Phone: +49571 887-0 | Fax: +49571 887-169

Email: info.de@wago.com | Web: www.wago.com

Do you have any questions about our products?

We are always happy to take your call at +49 (571) 887-44222.

	Item no.: 2009-145/000-006 Mini-WSB Inline; for Smart Printer; 1700 pieces on roll; stretchable 5 - 5.2 mm; plain; snap-on type; blue	www.wago.com/2009-145/000-006
	Item no.: 2009-145/000-007 Mini-WSB Inline; for Smart Printer; 1700 pieces on roll; stretchable 5 - 5.2 mm; plain; snap-on type; gray	www.wago.com/2009-145/000-007
	Item no.: 2009-145/000-012 Mini-WSB Inline; for Smart Printer; 1700 pieces on roll; stretchable 5 - 5.2 mm; plain; snap-on type; orange	www.wago.com/2009-145/000-012
	Item no.: 2009-145/000-023 Mini-WSB Inline; for Smart Printer; 1700 pieces on roll; stretchable 5 - 5.2 mm; plain; snap-on type; green	www.wago.com/2009-145/000-023
	Item no.: 2009-145/000-024 Mini-WSB Inline; for Smart Printer; 1700 pieces on roll; stretchable 5 - 5.2 mm; plain; snap-on type; violet	www.wago.com/2009-145/000-024
	Item no.: 248-501 Miniature WSB Quick marking system; plain; Marker width 5 mm; 10 strips with 10 markers per card	www.wago.com/248-501
	Item no.: 248-501/000-002 Mini-WSB marking card; as card; not stretchable; plain; snap-on type; yellow	www.wago.com/248-501/000-002
	Item no.: 248-501/000-005 Mini-WSB marking card; as card; not stretchable; plain; snap-on type; red	www.wago.com/248-501/000-005
	Item no.: 248-501/000-006 Mini-WSB marking card; as card; not stretchable; plain; snap-on type; blue	www.wago.com/248-501/000-006
	Item no.: 248-501/000-007 Mini-WSB marking card; as card; not stretchable; plain; snap-on type; gray	www.wago.com/248-501/000-007
	Item no.: 248-501/000-012 Mini-WSB marking card; as card; not stretchable; plain; snap-on type; orange	www.wago.com/248-501/000-012
	Item no.: 248-501/000-017 Mini-WSB marking card; as card; not stretchable; plain; snap-on type; light green	www.wago.com/248-501/000-017
	Item no.: 248-501/000-023 Mini-WSB marking card; as card; not stretchable; plain; snap-on type; green	www.wago.com/248-501/000-023
	Item no.: 248-501/000-024 Mini-WSB marking card; as card; not stretchable; plain; snap-on type; violet	www.wago.com/248-501/000-024

Subject to changes. Please also observe the further product documentation!

Protective Warning Marker



Item no.: 280-415

Protective warning marker; with high-voltage symbol, black; for 5 terminal blocks; yellow

www.wago.com/280-415**Downloads****Documentation****Bid Text**

769-219/281-413 doc - Datei	2. 10. 2017	doc 25.6 kB	Download
--------------------------------	-------------	----------------	----------

769-219/281-413 X81 - Datei	19. 2. 2019	xml 3.3 kB	Download
--------------------------------	-------------	---------------	----------

Additional Information

Technical explanations	3. 4. 2019	pdf 2.2 MB	Download
------------------------	------------	---------------	----------

CAD/CAE-Data**CAD data**

2D/3D Models 769-219/281-413		URL	Download
------------------------------	--	-----	----------

CAE data

EPLAN Data Portal 769-219/281-413		URL	Download
-----------------------------------	--	-----	----------

WSCAD Universe 769-219/281-413		URL	Download
--------------------------------	--	-----	----------

WSCAD Universe 769-219/281-413		URL	Download
--------------------------------	--	-----	----------

EPLAN Data Portal 769-219/281-413		URL	Download
-----------------------------------	--	-----	----------

ZUKEN Portal 769-219/281-413		URL	Download
------------------------------	--	-----	----------

Environmental Product Compliance**Compliance Search**

Environmental Product Compliance 769-219/281-413		URL	Download
--	--	-----	----------

Subject to changes. Please also observe the further product documentation!

1-conductor/1-pin component carrier terminal block; with 2 jumper positions; LED (red); 24 VDC; for DIN-rail 35 x 15 and 35 x 7.5; 4 mm²; CAGE CLAMP®; 4,00 mm²; gray

Installation Notes

Installation

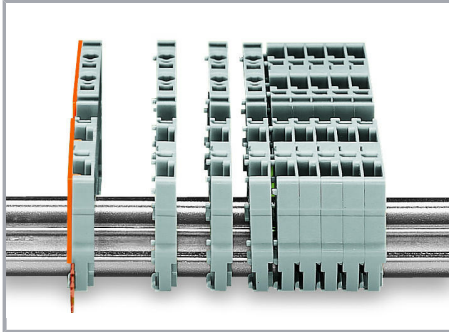

Snap individual carrier terminal blocks onto the DIN-rail and slide together.

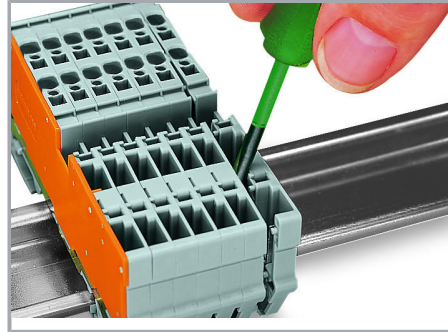

Open the assembly by laterally sliding a block via operating tool and remove terminal block via release lever.

Conductor termination

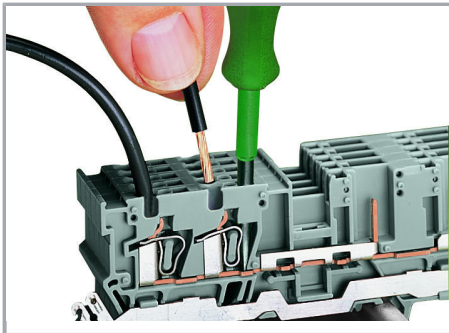

CAGE CLAMP® connection

Carrier terminal block: Insert/remove conductor via operating tool (3.5 x 0.5 mm blade).

Commoning

Subject to changes. Please also observe the further product documentation!

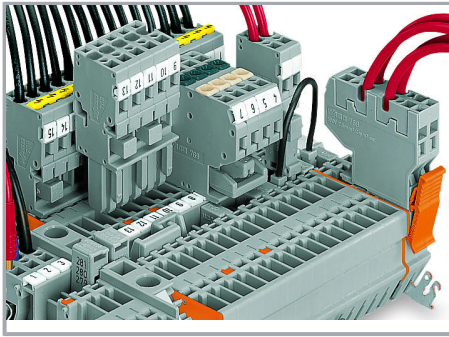

Commoning with adjacent or staggered jumpers.

Push jumpers down until fully inserted.

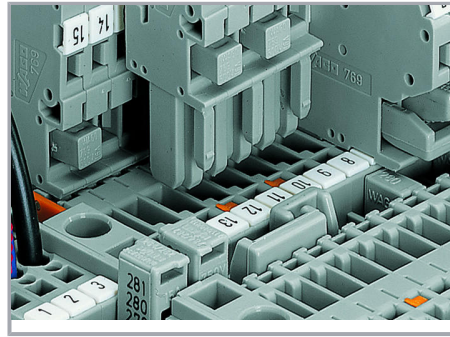

Commoning carrier terminal blocks via staggered jumpers.

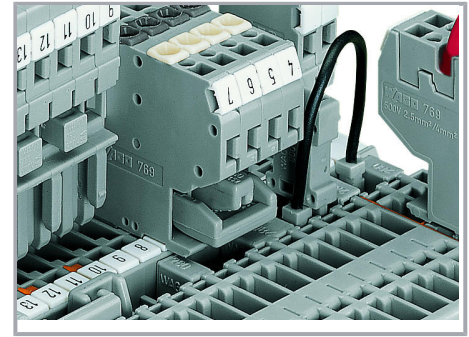

Commoning a 2-conductor female plug via staggered jumper and carrier terminal blocks via adjacent jumpers.

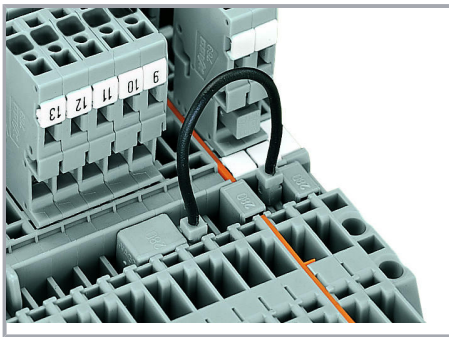

Commoning carrier terminal blocks via push-in type wire jumpers or adjacent jumpers – even over an intermediate plate.

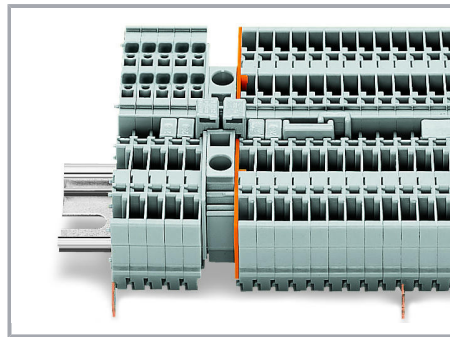

Commoning “supply terminal blocks” (up to 10 mm²/8 AWG) with carrier terminal blocks via step-down jumpers.

Testing

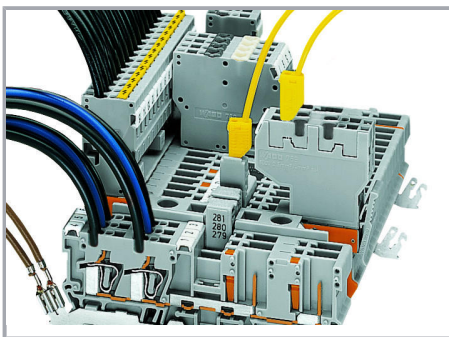

Testing with a 2.3 mm Ø test plug (max. 42 V).

Coding

Subject to changes. Please also observe the further product documentation!

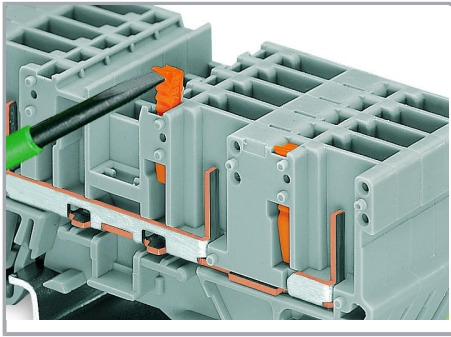

Snap coding pin in proper direction on carrier terminal block.

Shown: Coding pin removal from carrier terminal block.

Locking system

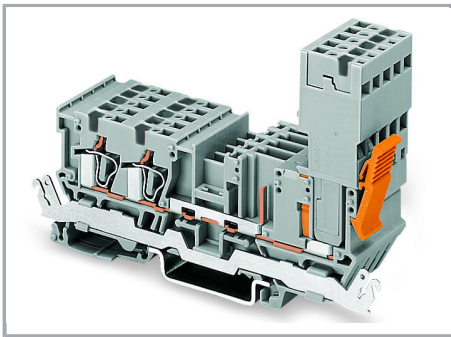

Securing a female plug via locking lever on the terminal block side.

Product family

X-COM

[Show all products from the family](#)

Subject to changes. Please also observe the further product documentation!