

# R&S® ZNLE VECTOR NETWORK ANALYZER



Measurements as easy as ABC



Data Sheet  
Version 04.00

**ROHDE & SCHWARZ**

Make ideas real



# AT A GLANCE

The R&S®ZNL6 makes vector network analyzer measurements as easy as ABC: easy to configure, easy to calibrate, easy to measure. The renowned high-quality design, an innovative user interface and its compact size make the R&S®ZNL6 ideal for basic VNA applications.

The R&S®ZNL6 is a two-port vector network analyzer that can be used for bidirectional measurements of S-parameters  $S_{11}$ ,  $S_{21}$ ,  $S_{12}$  and  $S_{22}$  on passive components.

Configuring the R&S®ZNL6 requires only three decisions:

- ▶ Choose the frequency range
- ▶ Decide whether you need a GPIB interface
- ▶ Decide whether you need to perform time domain analysis or distance-to-fault measurements

The analyzer is available with a frequency range of 100 kHz to 3 GHz (R&S®ZNL63 with R&S®ZNL6-B100 option), 100 kHz to 4.5 GHz (R&S®ZNL64 with R&S®ZNL6-B100 option) or 100 kHz to 6 GHz (R&S®ZNL66 with R&S®ZNL6-B100 option). The optional GPIB interface lets you connect a controller to remotely control the R&S®ZNL6.

As a standalone instrument, the R&S®ZNL6 does not require an external PC to configure the setup. You can start measuring immediately after you switch on the instrument. The time domain analysis option (R&S®ZNL6-K2) and distance-to-fault measurements option (R&S®ZNL6-K3) enhance the R&S®ZNL6 with essential features for general purpose testing.

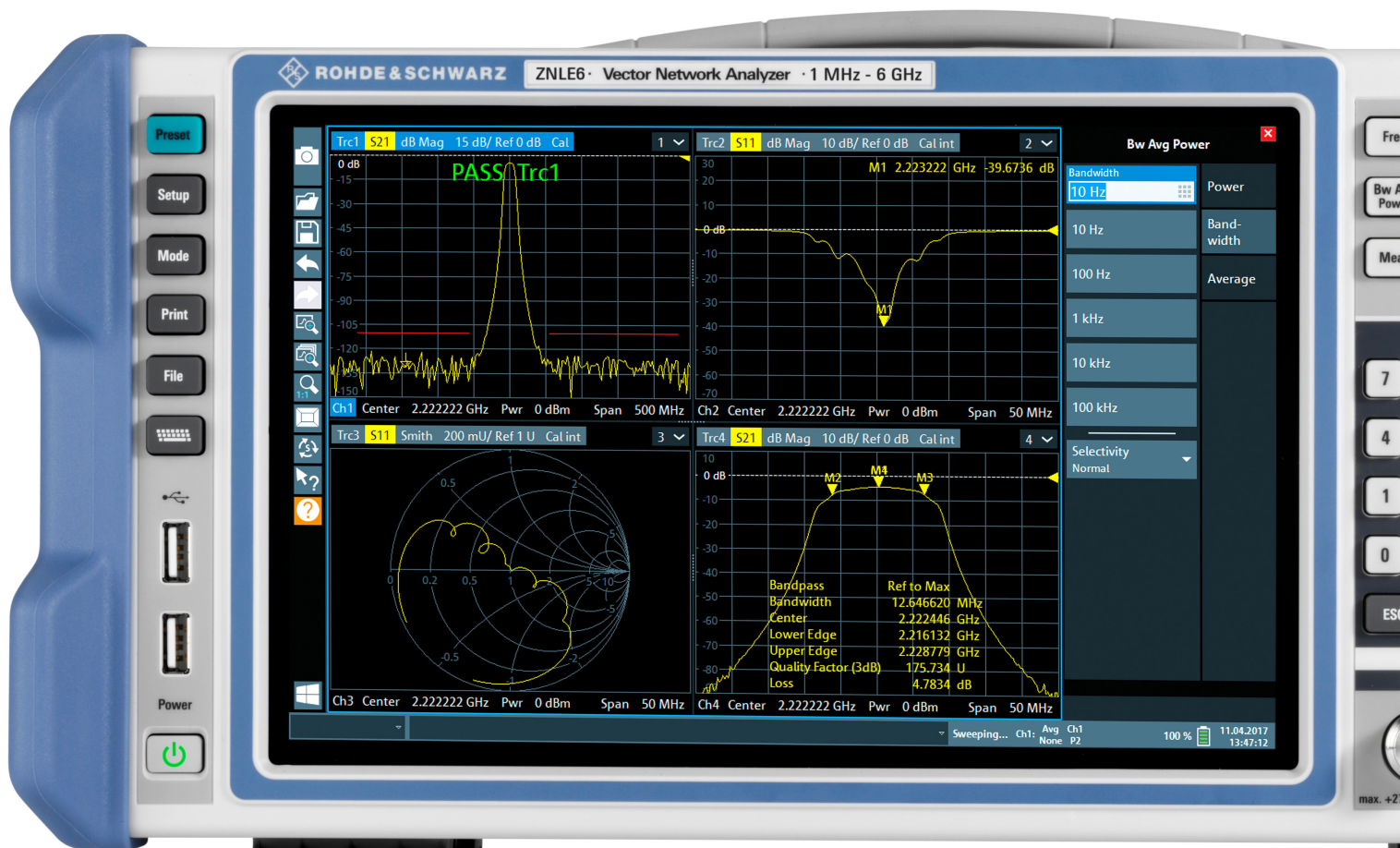

# BENEFITS

## An economical instrument with solid performance

- ▶ Compact vector network analyzer
- ▶ Low trace noise for high accuracy
- ▶ High measurement speed
- ▶ [page 4](#)

## User interface with multitouch screen

- ▶ Wide 10.1" WXGA multitouch screen
- ▶ Clearly structured user interface
- ▶ Undo/redo softkey for user-friendly operation
- ▶ Fully integrated context-sensitive help menu
- ▶ [page 5](#)

## Standard instrument for use in a lab

- ▶ Calibration units for quick calibration
- ▶ De/embedding functionality and fixture compensation
- ▶ Time domain analysis and distance-to-fault (DTF) measurements
- ▶ Remote controllable with LAN and GPIB option
- ▶ [page 8](#)

## Key features

- ▶ Frequency range from 100 kHz to 3 GHz, 100 kHz to 4.5 GHz or 100 kHz to 6 GHz
- ▶ Two-port vector network analyzer with a full S-parameter test set for bidirectional measurements on passive components
- ▶ Wide dynamic range of up to typ. 120 dB
- ▶ Measurement bandwidths from 1 Hz to 500 kHz
- ▶ Fast measurements, i.e. 8.7 ms for 401 points (100 kHz IFBW, 200 MHz span, correction off)
- ▶ Compact size (depth of 24 cm) and low weight (6 kg)
- ▶ Standalone instrument with 10.1" WXGA touchscreen
- ▶ Windows 10 operating system



# AN ECONOMICAL INSTRUMENT WITH SOLID PERFORMANCE

The R&S®ZNLE is a plug-and-play vector network analyzer containing everything needed to start a measurement. With a fully integrated powerful PC platform running the Windows 10 operating system, the R&S®ZNLE is a complete standalone analyzer. The solid-state hard disk delivers fast boot time and the reliability required for demanding applications. Configure measurements right on the R&S®ZNLE and save valuable bench space since there is no need for a mouse, keyboard and external monitor. Simply plug in the instrument and start measuring.

## Compact vector network analyzer

Vector network analyzers such as the R&S®ZNLE characterize electronic networks by measuring the magnitude and phase of S-parameters. Featuring an instrument depth of less than 24 cm and weighing only around 6 kg, the R&S®ZNLE is the most compact instrument in its class.

## Low trace noise for high accuracy

The R&S®ZNLE offers a low trace noise of typ. 0.001 dB (at 10 kHz measurement bandwidth). This allows highly accurate, stable and repeatable measurements even at wider IF bandwidths. Using larger measurement bandwidths, the R&S®ZNLE can perform faster measurements while still delivering excellent trace stability.

## High measurement speed

The R&S®ZNLE is up to 10 times faster than similar instruments. With a measurement speed of 9.6 ms for 201 points (100 kHz IFBW, 200 MHz span, full two-port calibration) and fast LAN or IEC/IEEE data transfer, the R&S®ZNLE meets the speed requirements encountered in production and in everyday testing.

## Comparison of footprint of different VNAs

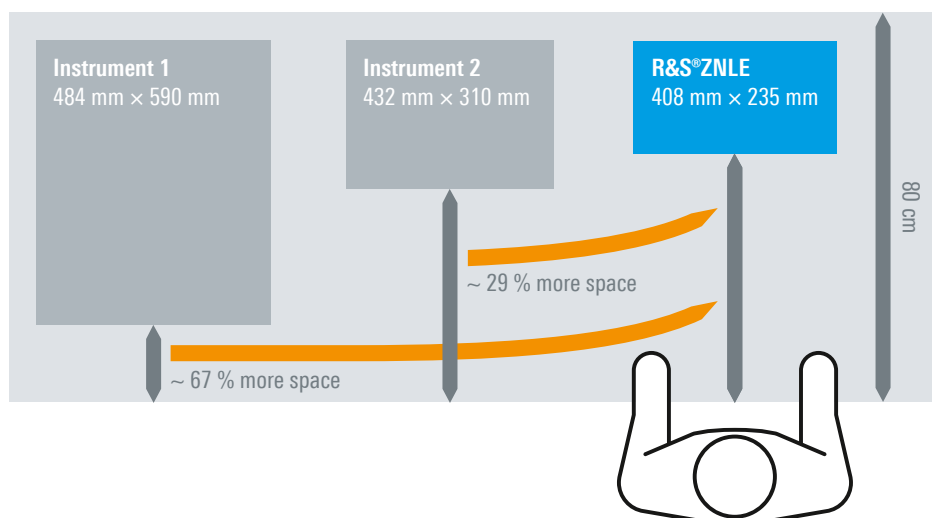

# USER INTERFACE WITH MULTITOUCH SCREEN

## Wide 10.1" WXGA multitouch screen

The wide 10.1" multitouch screen is perfect for displaying setups and arranging measurements as required by the current application. Simply drag&drop to adapt the layout to your needs. The multitouch capability of the R&S®ZNLE lets you do more than just move the traces around with the touch of a finger. You can also use gesturing to zoom in and out.

## Clearly structured user interface

The R&S®ZNLE features a user interface that is simple and clearly structured. Configure measurements in just a few steps. Drag and drop traces, channels and diagrams to achieve your ideal layout. Save, reload and switch between different setups with just a few screen taps.

## Undo/redo softkey for user-friendly operation

Use the undo and redo softkeys to cancel and restore measurement configurations. Check the influence of a measurement setting and revise it quickly, without having to reconfigure the entire measurement. To restart a setup from scratch, just press the Preset key.

## Fully integrated context-sensitive help menu

Thanks to the fully integrated help menu, help is just a click away. In every dialog window, the R&S®ZNLE has a help button that takes you directly to the relevant section of the user manual. The help softkey is located on the left side of the display and can be accessed at any time. An integrated search function lets you quickly find different topics and functions.

Overview of the R&S®ZNLE user interface. Here the wizard for easy configuration of S-parameters and the context-sensitive help menu are open.

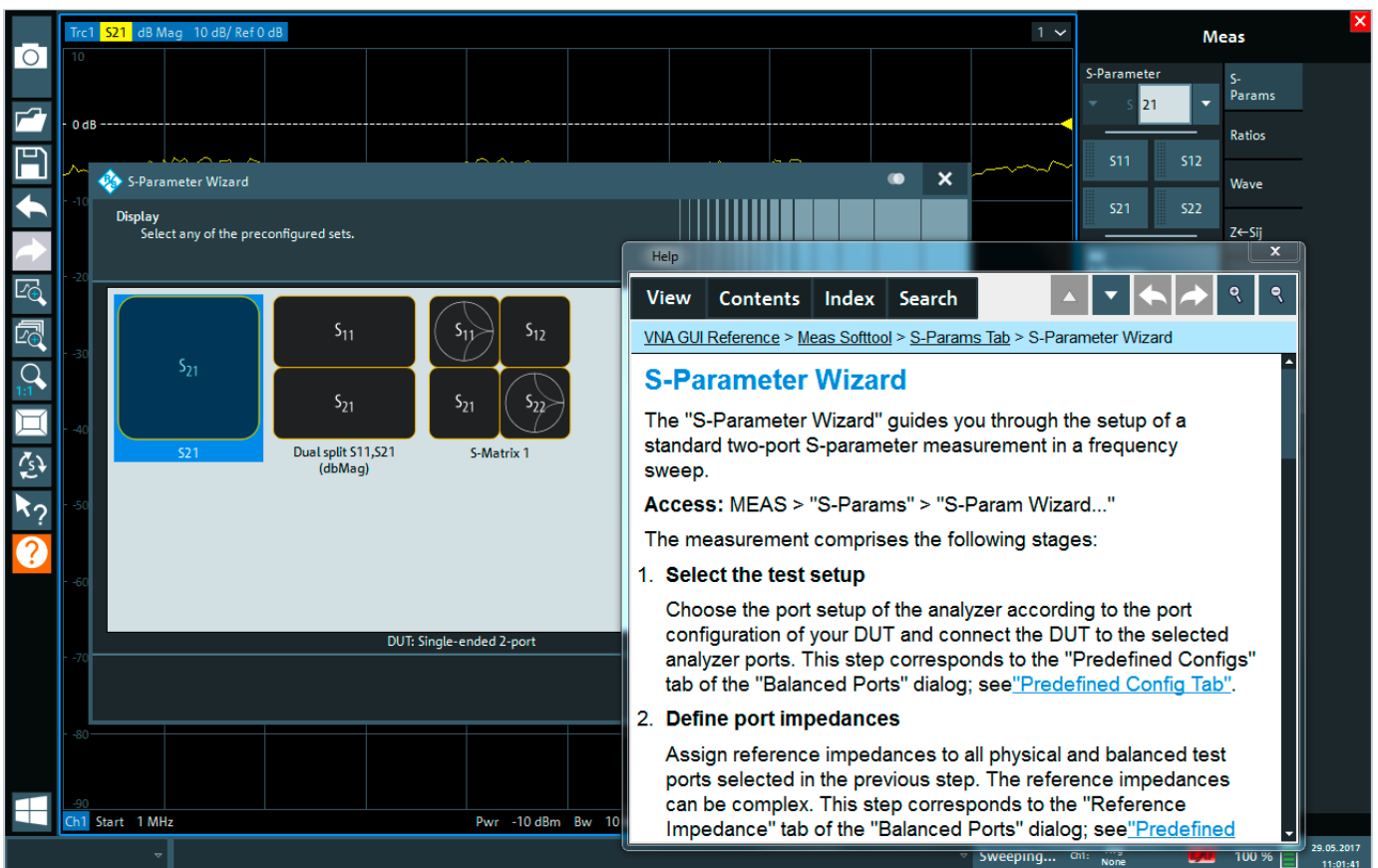



# FRONT PANEL OVERVIEW

## 10.1" high-resolution display

- ▶ 1280 × 800 pixel

## Toolbar

- ▶ With standard application functions such as print, save/open file, undo, redo, help

## System keys

- ▶ For setup, presets, settings, etc.

## Two USB 2.0 ports

- ▶ For storage media
- ▶ For connecting accessories

## Status bar



### Softkey bar

- ▶ Quick access to key tools
- ▶ Hardware settings at a glance

### Numerical keypad

- ▶ With unit keys for frequency and level

### Function keys

### Control knob

### Port 1

### Port 2/RF input

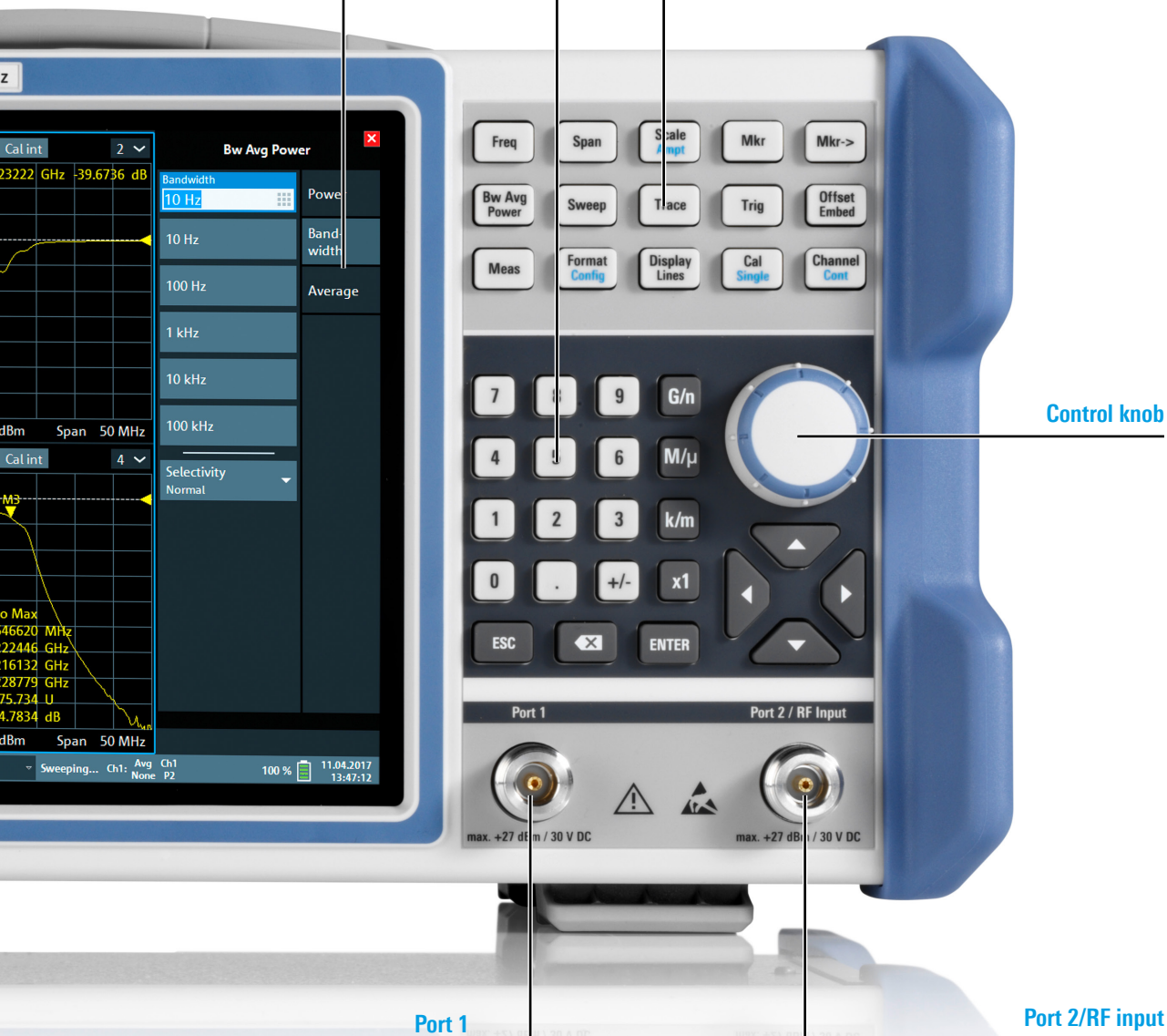

# STANDARD INSTRUMENT FOR USE IN A LAB

In development, it is often necessary to measure passive components quickly. The R&S®ZNL E not only delivers solid RF performance, it also offers features that make your life easier.

## Calibration units for quick calibration

The R&S®ZNL E calibration wizard guides you through the calibration process. Manual calibration kits and automatic calibration units are supported.

The analyzer's automatic calibration unit minimizes the time needed to perform full system error correction. The calibration unit is ready for use right after it is connected to the R&S®ZNL E. It only takes a few steps to calibrate the setup. This is especially an advantage in production environments, helping you save time and maximize throughput.

The following calibration procedures are available:

- ▶ Reflection normalization open or short
- ▶ Reflection OSM (OSL)
- ▶ Enhanced reflection normalization OM or SM
- ▶ Transmission normalization (response calibration)
- ▶ Transmission normalization both (response calibration)
- ▶ One path two ports
- ▶ TOSM (SOLT)
- ▶ UOSM (only with calibration unit)

## De/embedding functionality and fixture compensation

It is often necessary to characterize single components that are specified together with a matching network. The R&S®ZNL E can embed the DUT into virtual matching networks to achieve realistic conditions when simulating the DUT in its operational environment. The R&S®ZNL E offers a choice of predefined matching network topologies. It is also possible to read \*.s2p files into the R&S®ZNL E and use them for deembedding/embedding.

The fixture compensation feature corrects the measurement results by compensating for the effect of a test fixture.

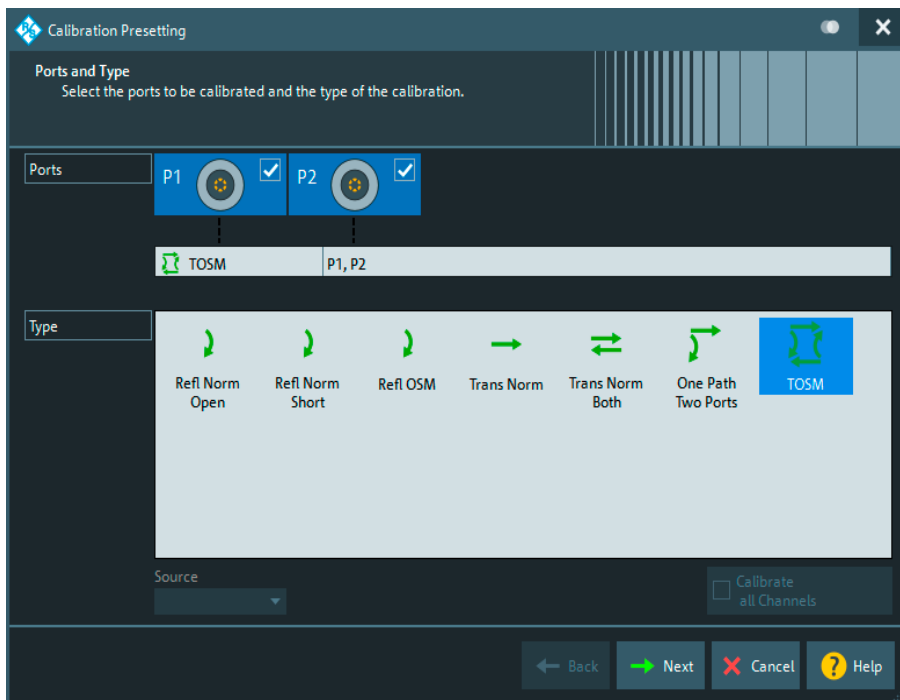

The calibration wizard provides an overview of the possible calibration methods for easy selection.



## Time domain analysis and distance-to-fault (DTF) measurements

Some measurements require the characterization of a specific component of a composite DUT (for example an antenna of an IoT device). With the R&S®ZNL-K2 option, the R&S®ZNL lets you analyze the DUT in the time domain and use the time gating function to isolate the required circuit section.

The distance-to-fault measurements option (R&S®ZNL-K3) lets you detect cable discontinuities, which is important for example for base station antenna installation. You can select from a range of common cable types with pre-defined velocity factor and frequency-dependent attenuation, or create your own cable profiles. The R&S®ZNL-K2 and R&S®ZNL-K3 options use internal DC extrapolation. The optional frequency extension down to 100 kHz (R&S®ZNL-B100) is helpful as it provides improved accuracy.

## Remote controllable with LAN and GPIB option

The R&S®ZNL can be remote controlled via the integrated LAN interface. The optional GPIB interface lets you connect a controller to remotely control the R&S®ZNL. Data is transmitted bidirectionally on the 8-bit parallel bus. The data measured during a sweep is transferred to the controller while the next sweep is in progress. As a result, the R&S®ZNL has virtually negligible data transfer time.



The fixture compensation menu offers a good overview of all available compensation methods.

# Specifications

## Measurement range

Impedance		50 Ω
Test port connector		N female
Number of test ports		2
Frequency range <sup>1</sup>	without R&S®ZNLE-B100 low frequency extension option	
	R&S®ZNLE3	1 MHz to 3 GHz
	R&S®ZNLE4	1 MHz to 4.5 GHz
	R&S®ZNLE6	1 MHz to 6 GHz
	with R&S®ZNLE-B100 B100 low frequency extension option	
	R&S®ZNLE3	100 kHz to 3 GHz
	R&S®ZNLE4	100 kHz to 4.5 GHz
R&S®ZNLE6	100 kHz to 6 GHz	

Static frequency accuracy		(time since last adjustment × aging rate) + temperature drift + calibration accuracy
Aging per year		$\pm 1 \times 10^{-6}$
Temperature drift (+5 °C to +40 °C)		$\pm 1 \times 10^{-6}$
Achievable initial calibration accuracy		$\pm 5 \times 10^{-7}$

Frequency resolution		1 Hz
Number of measurement points	per trace	1 to 5001
Measurement bandwidth	1/1.5/2/3/5/7 steps	1 Hz to 500 kHz

		<b>specification</b>	<b>typical</b>
Dynamic range <sup>1,2</sup>	100 kHz to 50 MHz	> 100 dB	110 dB
	50 MHz to 6 GHz	> 110 dB	120 dB

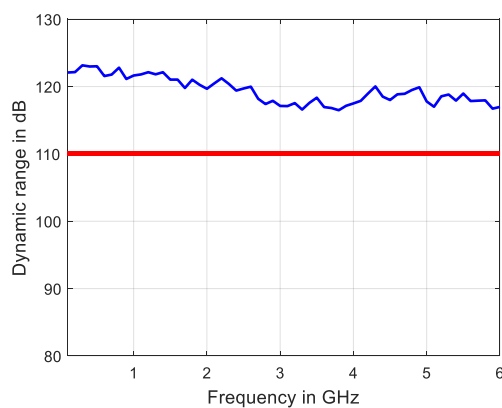
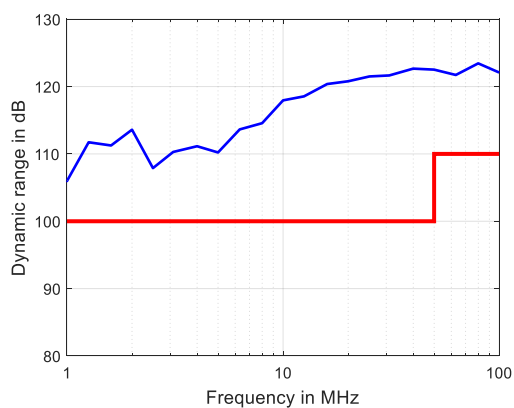

*Dynamic range in dB versus frequency for the R&S®ZNLE*

<sup>1</sup> Specified and typical data given in this data sheet apply to the R&S®ZNLE3, the R&S®ZNLE4 and the R&S®ZNLE6; please note their respective frequency ranges.

<sup>2</sup> The dynamic range is defined as the difference between 0 dBm source power and the RMS value of the data trace of the transmission magnitude, which is produced by noise and crosstalk with the test ports short-circuited. The specification applies at 10 Hz measurement bandwidth, without system error correction. The dynamic range can be increased by using a measurement bandwidth of 1 Hz.

# Measurement speed

Measured with firmware version 1.00 and Windows 10, 64 bit.

Measurement time	for 201 measurements points, with 200 MHz span, 500 kHz measurement bandwidth	$T_{SWEEP}$	$T_{CYCLE}$
	with 900 MHz center frequency	< 4.0 ms	< 5.0 ms
Acquisition time per point ( $T_{ACQ}$ )	500 kHz measurement bandwidth, CW mode	< 10 $\mu$ s	
Sampling time per point ( $T_{SAMPLE}$ )	at 500 kHz measurement bandwidth	4.5 $\mu$ s	
	IF filter: normal		
Time for measurement and data transfer	for 201 measurements points, with 800 MHz start frequency, 1 GHz stop frequency, 500 kHz measurement bandwidth <sup>3</sup>	IEC/IEEE	VXI11
		over 1 Gbit/s LAN	
		10 ms typ.	10 ms typ.
			10 ms typ.
Data transfer time	for 201 measurements points (magnitude)	3 ms typ.	2.5 ms typ.
Switching time between channels	with a maximum of 2001 points	< 5 ms	
Switching time between two preloaded instrument settings	with a maximum of 2001 points	< 5 ms	

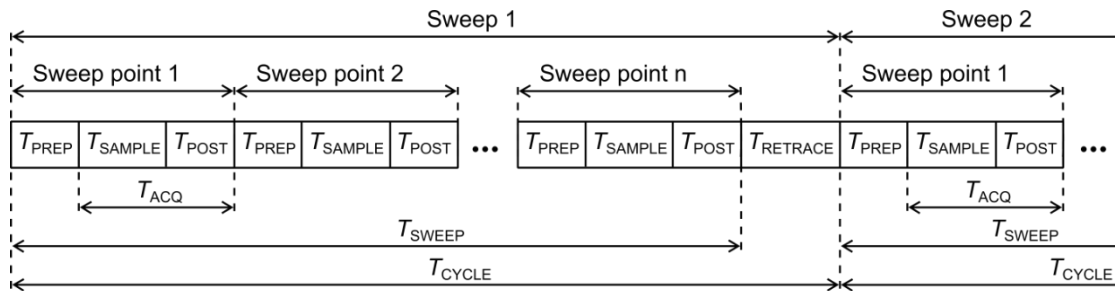

- $T_{PREP}$  Preparation time required to set up the internal hardware components
- $T_{SAMPLE}$  Sampling time (approximately equal to the settling time of the digital filters)
- $T_{POST}$  Time required for hardware postprocessing
- $T_{ACQ}$  Acquisition time ( $T_{SAMPLE} + T_{POST}$ )
- $T_{SWEEP}$  Time required for one sweep
- $T_{RETRACE}$  Time between two sweeps
- $T_{CYCLE}$  Sweep cycle time ( $T_{SWEEP} + T_{RETRACE}$ )

## Measurement sequence

Typical sweep times versus number of measurement points <sup>1, 4</sup>					
Number of measurement points	51	201	401	1601	5001
800 MHz start frequency, 1 GHz stop frequency, 100 kHz measurement bandwidth					
With correction switched off	2.4 ms	4.9 ms	8.7 ms	31.2 ms	94 ms
With 2-port TOSM calibration	3.9 ms	9.6 ms	16.7 ms	61.7 ms	189 ms
800 MHz start frequency, 1 GHz stop frequency, 1 kHz measurement bandwidth					
With correction switched off	66 ms	258 ms	515 ms	2055 ms	6400 ms
With 2-port TOSM calibration	132 ms	515 ms	1028 ms	4100 ms	12780 ms
100 MHz start frequency, 3 GHz stop frequency, 100 kHz measurement bandwidth					
With correction switched off	3.9 ms	9.1 ms	14.5 ms	36.7 ms	102 ms
With 2-port TOSM calibration	7.3 ms	17.7 ms	28.8 ms	73.3 ms	206 ms
100 MHz start frequency, 3 GHz stop frequency, 1 kHz measurement bandwidth					
With correction switched off	68 ms	262 ms	519 ms	2055 ms	6390 ms
With 2-port TOSM calibration	136 ms	524 ms	1040 ms	4110 ms	12800 ms
100 MHz start frequency, 6 GHz stop frequency, 100 kHz measurement bandwidth					
With correction switched off	3.9 ms	9.5 ms	15.4 ms	47 ms	104 ms
With 2-port TOSM calibration	7.3 ms	18.8 ms	30.5 ms	95 ms	209 ms
100 MHz start frequency, 6 GHz stop frequency, 1 kHz measurement bandwidth					
With correction switched off	68 ms	263 ms	521 ms	2070 ms	6400 ms
With 2-port TOSM calibration	136 ms	525 ms	1042 ms	4120 ms	12800 ms

<sup>3</sup> In continuous mode, no additional time for data transfer is needed as this occurs simultaneously during the measurement.

<sup>4</sup> Sweep time is to be understood as cycle time; static frequency accuracy of the instrument applies; measured with firmware version 1.00, Windows 10.

# Measurement accuracy

This data is valid between +18 °C and +28 °C, provided the temperature has not varied by more than 1 °C since calibration. Validity of the data is conditional on the use of an R&S®ZV-Z270 calibration kit and TOSM/SOLT calibration. This calibration kit is used to achieve the effective system data specified below. Frequency points, measurement bandwidth and sweep time have to be identical for measurement and calibration (no interpolation allowed).

Accuracy of transmission measurements		
Above 100 kHz	+5 dB to -35 dB	< 0.05 dB or < 0.5°
	-35 dB to -50 dB	< 0.1 dB or < 1°
	-50 dB to -65 dB	< 0.2 dB or < 2°
Specifications are based on a matched DUT, a measurement bandwidth of 10 Hz and a nominal source power of -10 dBm.		

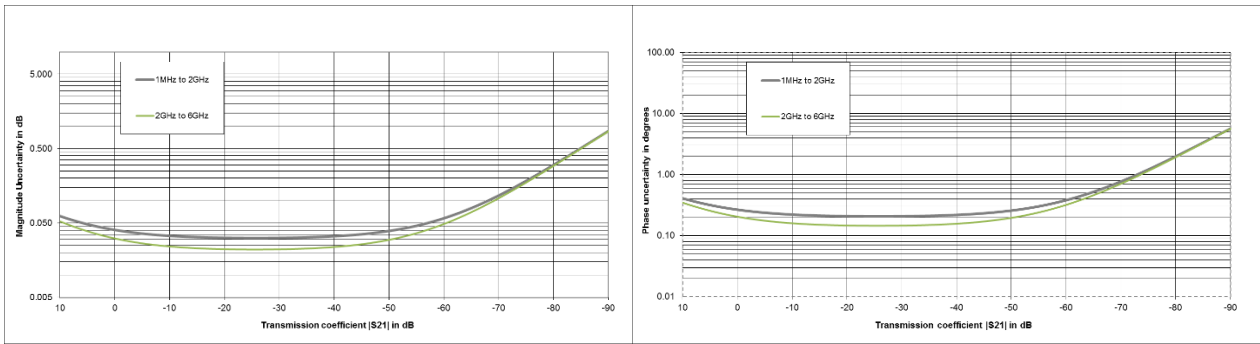

Typical accuracy of transmission magnitude and transmission phase measurements for the R&S®ZNLE<sup>1</sup>; analysis conditions:  $S_{11} = S_{22} = 0$ , calibrated power -10 dBm, measured power -10 dBm

Accuracy of reflection measurements	logarithmic			linear	
		magnitude	phase		magnitude
100 kHz to 6 GHz	0 dB	≤ 0.20 dB	≤ 1.3°	0 dB to -3 dB	0.024
	-3 dB	≤ 0.20 dB	≤ 1.3°	< -3 dB to -6 dB	0.016
	-6 dB	≤ 0.25 dB	≤ 1.5°	< -6 dB to -15 dB	0.013
	-15 dB	≤ 0.58 dB	≤ 4.0°	< -15 dB to -25 dB	0.012
	-25 dB	≤ 1.80 dB	≤ 13°	< -25 dB to -35 dB	0.012
	-35 dB	≤ 4.50 dB	≤ 42°		
Specifications are based on an isolating DUT, a measurement bandwidth of 10 Hz and a nominal source power of -10 dBm.					

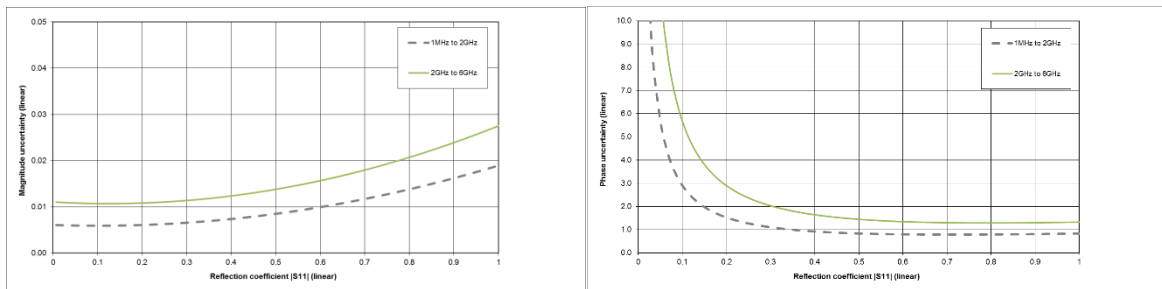

Typical accuracy of reflection magnitude and reflection phase measurements for the R&S®ZNLE<sup>1</sup>; analysis conditions:  $S_{12} = S_{21} = 0$ , calibrated power -10 dBm, measured power -10 dBm

## Effective system data

This data is valid between +18 °C and +28 °C, provided the temperature has not varied by more than 1 °C after calibration. Frequency points, measurement bandwidth and sweep time have to be identical for measurement and calibration (no interpolation allowed). The data is based on a measurement bandwidth of 10 Hz and system error calibration with an R&S®ZV-Z270 calibration kit using TOSM/SOLT with an R&S®ZV-Z270 calibration kit.

R&S®ZNLE <sup>1</sup>	100 kHz to 6 GHz
Directivity	≥ 40 dB
Source match	≥ 36 dB
Load match	≥ 40 dB
Reflection tracking	≤ 0.05 dB
Transmission tracking	≤ 0.05 dB

## Factory-calibrated system data

This data is valid between +18 °C and +28 °C. It is based on a source power of -10 dBm and a measurement bandwidth of 1 kHz.

		specification	typical
Directivity	100 kHz to 6 GHz	≥ 20 dB	30 dB
Source match	100 kHz to 6 GHz	≥ 20 dB	30 dB
Reflection tracking	100 kHz to 6 GHz	≤ 1.5 dB	0.5 dB
Transmission tracking	100 kHz to 6 GHz	≤ 1.5 dB	0.5 dB
Load match (raw test port match)	100 kHz to 3 GHz	≥ 14 dB	18 dB
Load match (raw test port match)	3 GHz to 6 GHz	≥ 12 dB	16 dB

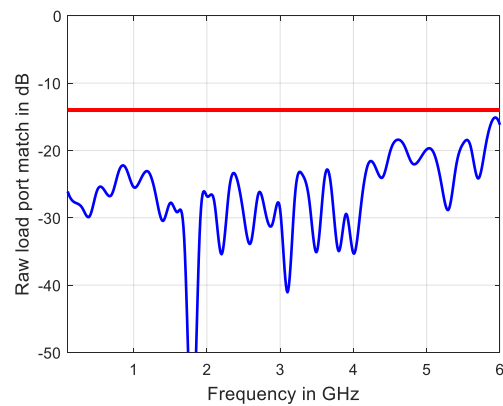
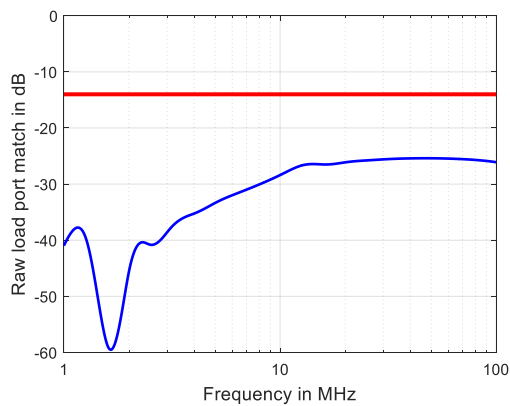

Raw load port match versus frequency for the R&S®ZNLE

Trace stability			specification	typical
Trace noise magnitude (RMS)	at 0 dBm source power, 0 dB reflection	IF bandwidth		
	100 kHz to 10 MHz	10 kHz	< 0.005 dB	0.001 dB
	10 MHz to 6 GHz	10 kHz	< 0.005 dB	0.001 dB
Trace noise phase (RMS)	at 0 dBm source power, 0 dB reflection	IF bandwidth		
	100 kHz to 10 MHz	10 kHz	< 0.1	
	10 MHz to 6 GHz	10 kHz	< 0.05	0.01°
Temperature dependence	at 0 dB transmission or reflection			
	100 kHz to 6 GHz	magnitude phase		0.05 dB/K 0.8°/K



## Test port output

This data is valid from +18 °C to +28 °C.

		<b>specification</b>	<b>typical</b>
Power range	100 kHz to 6 GHz	-10 dBm to 0 dBm	up to +2 dBm
Power accuracy, source power -10 dBm	100 kHz to 6 GHz	≤ 2 dB	0.5 dB
Power linearity referenced to -10 dBm		≤ 1.5 dB	
Power resolution		0.01 dB	
Harmonics source power -10 dBm	100 kHz to 6 GHz		-30 dBc

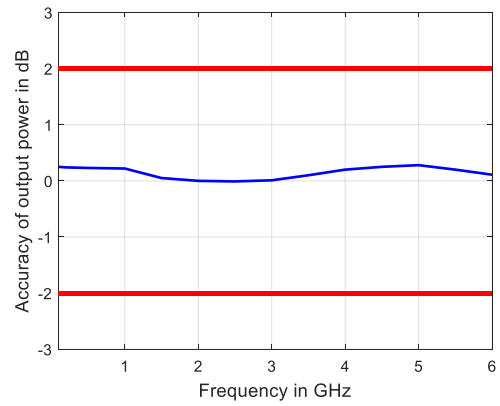
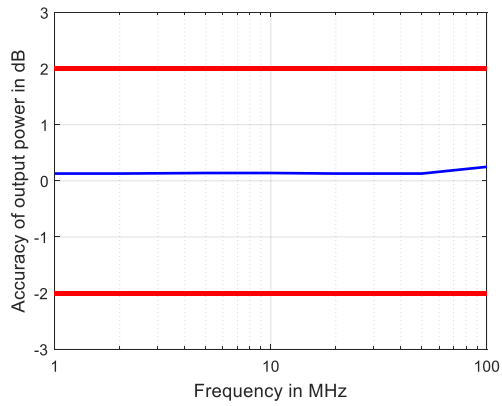

*Output power accuracy in dB versus frequency for the R&S®ZNLE base unit*

## Test port input

		specification	typical
Maximum nominal input level		0 dBm	
Power measurement accuracy	at -10 dBm without power calibration		
	100 kHz to 6 GHz	< 2 dB	0.3 dB
Receiver linearity referenced to -10 dBm	+10 dB to +5 dB	< 0.3 dB	0.2 dB
	+5 dB to -40 dB	< 0.2 dB	0.1 dB
Damage level		+27 dBm	
Damage DC voltage		30 V	
Noise level at 1 kHz measurement bandwidth, normalized to 1 Hz	100 kHz to 50 MHz	< -110 dBm (1 Hz)	-130 dBm (1 Hz)
	50 MHz to 6 GHz	< -120 dBm (1 Hz)	-130 dBm (1 Hz)

The noise level is defined as the RMS value of the specified noise floor.

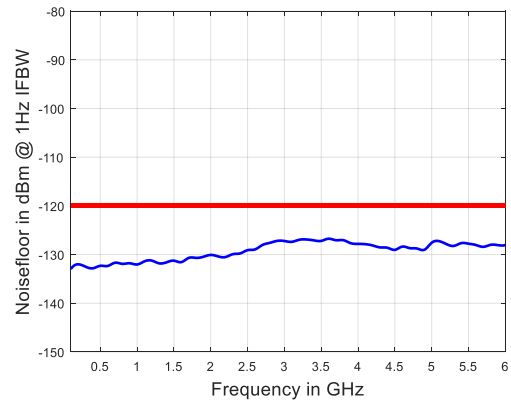
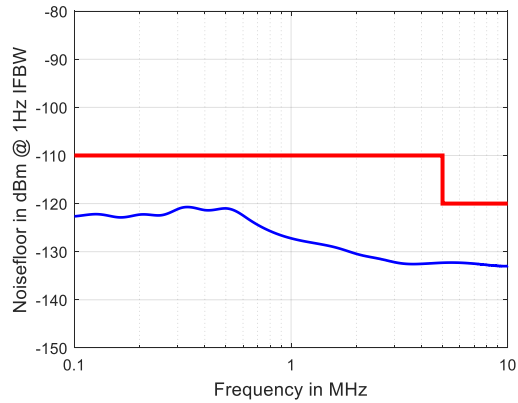

Noise level in dBm (1 Hz) versus frequency for the R&S®ZNLE

## Additional front panel connectors

USB	two universal serial bus connectors for connecting USB devices (USB 2.0); two additional USB 3.0 connectors on rear panel
-----	--

## Display

Screen	26.4 cm (10.1") diagonal WXGA color LCD with touchscreen
Resolution	1280 × 800 × 262144 (high color, 125 dpi)
Pixel failure rate	$< 1 \times 10^{-5}$

## Rear panel connectors

LAN	local area network connector, 10/100/1000BASE-T, 8-pin, RJ-45
-----	---

USB	(two) universal serial bus connectors for connecting USB devices (USB 3.0); two additional USB 2.0 connectors on front panel
-----	---

MONITOR	DVI-D connector (for external monitor)
---------	--

<b>REF IN</b>	input for external frequency reference signal	
Connector type		BNC, female
Input frequency		10 MHz
Maximum permissible deviation		1 kHz
Input power		-10 dBm to +15 dBm at 50 Ω
Input impedance		> 10 kΩ

<b>REF OUT</b>	output for external frequency reference signal	
Connector type		BNC, female
Output frequency		10 MHz
Output frequency accuracy		80 Hz
Output power		+6 dBm ± 4 dB at 50 Ω

<b>EXT TRIG IN</b>	trigger input for analyzer	
Connector type		BNC, female
TTL signal (edge-triggered or level-triggered)		3 V, 5 V tolerant
Polarity (selectable)		positive or negative
Minimum pulse width		1 μs
Input impedance		> 10 kΩ

# Options

For subsequently activated options, all data sheet parameters are typical values until a calibration is performed.

## R&S®FPL1-B10

<b>GPIB interface</b>	remote control interface in line with IEEE 488, IEC 60625; 24-pin
-----------------------	---

## General data

Data storage		
Internal	standard	solid-state drive 32 Gbyte (nom.)
External		supports USB-2.0-compatible memory devices

Environmental conditions		
Temperature	operating temperature range	+5 °C to +40 °C
	storage temperature range	-20 °C to +70 °C
Climatic loading	without condensation	+40 °C at 85 % rel. humidity, in line with EN 60068-2-30,

Mechanical resistance		
Vibration	sinusoidal	5 Hz to 55 Hz 0.15 mm constant amplitude (1.8 g at 55 Hz), 55 Hz to 150 Hz acceleration: 0.5 g constant, in line with EN 60068-2-6
	random	10 Hz to 300 Hz, acceleration 1.2 g (RMS), in line with EN 60068-2-64
Shock		40 g shock spectrum, in line with MIL-STD-810E method No. 516.4 procedure I, MIL-PRF-28800F

<b>EMC</b>		in line with EMC Directive 2014/30/EU including IEC/EN 61326-1 <sup>5, 6</sup> , IEC/EN 61326-2-1, CISPR 11/EN 55011 <sup>5</sup> , IEC/EN 61000-3-2, IEC/EN 61000-3-3
------------	--	---

<b>Recommended calibration interval</b>		1 year
---	--	--------

Power supply		
AC supply		100 V to 240 V $\pm$ 10 %, 50 Hz to 60 Hz $\pm$ 5 %, 400 Hz $\pm$ 5 % class of protection I, in line with VDE 411
Current consumption		1.7 A to 0.8 A
Power consumption		max. 170 W, 80 W (typ.)
Safety		in line with EN 61010-1, IEC 61010-1, UL 61010-1, CAN/CSA-C22.2 No. 61010-1
Test mark		CSA, CSA-NRTL

Dimensions and weight		
Dimensions	W x H x D	408 mm x 186 mm x 235 mm (16.06 in x 7.32 in x 9.25 in)
Net weight, nominal		6 kg (13.22 lb)

<sup>5</sup> Emission limits for class A equipment.

<sup>6</sup> Immunity test requirement for industrial environment (EN 61326 table 2).



# Dimensions (in mm)

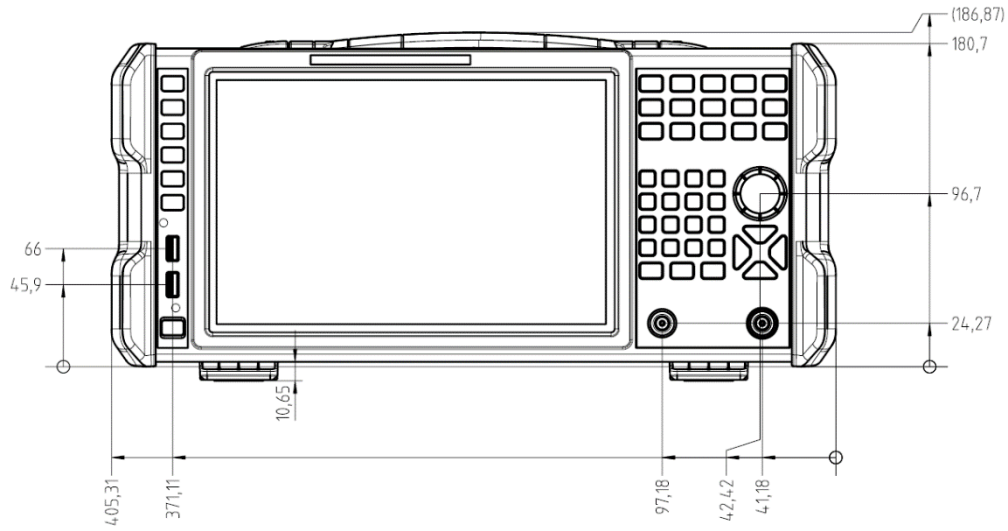

Front view

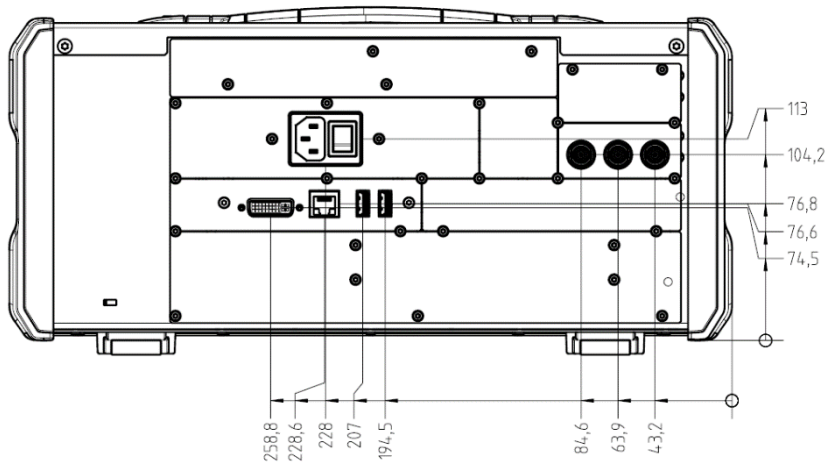

Rear view

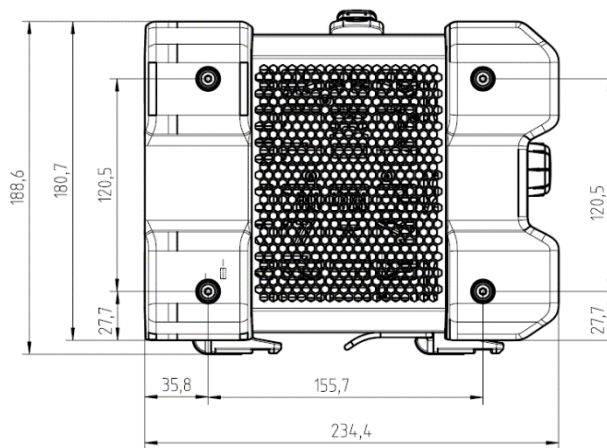

Side view

# Ordering information

Designation	Type	Retrofit <sup>7</sup>	On site <sup>8</sup>	Order No.
<b>Base unit</b>				
Vector network analyzer, two ports, 3 GHz, N	R&S <sup>®</sup> ZNLE3			1323.0012.53
Vector network analyzer, two ports, 4.5 GHz, N	R&S <sup>®</sup> ZNLE4			1323.0012.54
Vector network analyzer, two ports, 6 GHz, N	R&S <sup>®</sup> ZNLE6			1323.0012.56
<b>Options</b>				
Low frequency extension	R&S <sup>®</sup> ZNLE-B100	•	–	1303.9272.02
GPIB interface	R&S <sup>®</sup> FPL1-B10	•	•	1323.1890.02
<b>Firmware/software</b>				
Time domain analysis	R&S <sup>®</sup> ZNL-K2	•	•	1323.1819.02
Distance-to-fault measurement	R&S <sup>®</sup> ZNL-K3	•	•	1323.1825.02

<b>Warranty</b>				
Base unit			3 years	
All other items <sup>9</sup>			1 year	
<b>Options</b>				
Extended warranty, one year	R&S <sup>®</sup> WE1	Please contact your local Rohde & Schwarz sales office.		
Extended warranty, two years	R&S <sup>®</sup> WE2			
Extended warranty with calibration coverage, one year	R&S <sup>®</sup> CW1			
Extended warranty with calibration coverage, two years	R&S <sup>®</sup> CW2			
Extended warranty with accredited calibration coverage, one year	R&S <sup>®</sup> AW1			
Extended warranty with accredited calibration coverage, two years	R&S <sup>®</sup> AW2			

### Extended warranty with a term of one and two years (WE1 and WE2)

Repairs carried out during the contract term are free of charge <sup>10</sup>. Necessary calibration and adjustments carried out during repairs are also covered.

### Extended warranty with calibration coverage (CW1 and CW2)

Enhance your extended warranty by adding calibration coverage at a package price. This package ensures that your Rohde & Schwarz product is regularly calibrated, inspected and maintained during the term of the contract. It includes all repairs <sup>10</sup> and calibration at the recommended intervals as well as any calibration carried out during repairs or option upgrades.

### Extended warranty with accredited calibration (AW1 and AW2)

Enhance your extended warranty by adding accredited calibration coverage at a package price. This package ensures that your Rohde & Schwarz product is regularly calibrated under accreditation, inspected and maintained during the term of the contract. It includes all repairs <sup>10</sup> and accredited calibration at the recommended intervals as well as any accredited calibration carried out during repairs or option upgrades.

<sup>7</sup> Option may also be ordered at a later stage, upgrade in service.

<sup>8</sup> Option may be installed by the user on site.

<sup>9</sup> For options that are installed, the remaining base unit warranty applies if longer than 1 year.

<sup>10</sup> Excluding defects caused by incorrect operation or handling and force majeure. Wear-and-tear parts are not included.



## Service that adds value

- ▶ Worldwide
- ▶ Local und personalized
- ▶ Customized and flexible
- ▶ Uncompromising quality
- ▶ Long-term dependability

## Rohde & Schwarz

The Rohde & Schwarz electronics group offers innovative solutions in the following business fields: test and measurement, broadcast and media, secure communications, cybersecurity, monitoring and network testing. Founded more than 80 years ago, the independent company which is headquartered in Munich, Germany, has an extensive sales and service network with locations in more than 70 countries.

[www.rohde-schwarz.com](http://www.rohde-schwarz.com)

## Sustainable product design

- ▶ Environmental compatibility and eco-footprint
- ▶ Energy efficiency and low emissions
- ▶ Longevity and optimized total cost of ownership

Certified Quality Management  
**ISO 9001**

Certified Environmental Management  
**ISO 14001**

## Rohde & Schwarz training

[www.training.rohde-schwarz.com](http://www.training.rohde-schwarz.com)

## Rohde & Schwarz customer support

[www.rohde-schwarz.com/support](http://www.rohde-schwarz.com/support)

