

## 2JDK0301Ca-A28

### GNSS Ceramic Thru-Hole Mount Development Kit

#### Key Features

GPS/GLONASS/BeiDou/QZSS/Galileo  
- 1561-1606 MHz

Set of 6 patches to try on devices

Thru-Hole Mount

High Gain

Ground Plane Independent

Patches Dimensions 36 x 36 x 4 mm

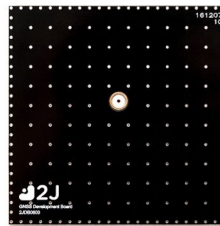

## 1. Antenna and electrical specifications

Parameters	GNSS Ceramic Thru-Hole Mount Antenna		
	BeiDou	GPS/QZSS/Galileo	GLONASS
<b>Standards</b>			
<b>Bands (MHz)</b>	1561	1575	1602
<b>Frequency (MHz)</b>			
2JCP3640101Ca (2J46)	1561.098	1575.42	1598-1606
2JCP3640102Ca (2J47)	1566.098	1580.42	1603-1611
2JCP3640103Ca (2J48)	1571.098	1585.42	1608-1616
2JCP3640104Ca (2J49)	1576.098	1590.42	1613-1621
2JCP3640105Ca (2J50)	1581.098	1595.42	1618-1626
2JCP3640106Ca (2J51)	1586.098	1600.42	1623-1631
<b>Return Loss (dB)</b>	~-13.0	~-15.0	~-19.1
<b>VSWR</b>	~1.6:1	~1.4:1	~1.3:1
<b>Efficiency (%)</b>	~73	~69	~71
<b>Peak Gain (dBiC)</b>	~4.0	~3.8	~4.1
<b>Average Gain (dB)</b>	~-1.3	~-1.6	~-1.4
<b>Impedance (Ohms)</b>		50	
<b>Radiation Pattern</b>		Hemispherical	
<b>Polarization</b>		RHCP	

### Antenna Measurement Conditions:

Free Space

Mounted on Ground Plane of 70 x 70 mm

Measured in Certified CTIA 3D Anechoic Chamber

## 2. Mechanical and environmental specifications

Specifications	2JCP3640101Ca
<b>Mounting Type</b>	Thru-Hole Mount
<b>Adhesive</b>	Nitto 5000NS
<b>Dimensions (mm)</b>	36 x 36 x 4
<b>Operating Temperature (C)</b>	-40 to +85
<b>Storage Temperature (C)</b>	-40 to +85
<b>Substance Compliance</b>	RoHS

### 3. Antenna parameters

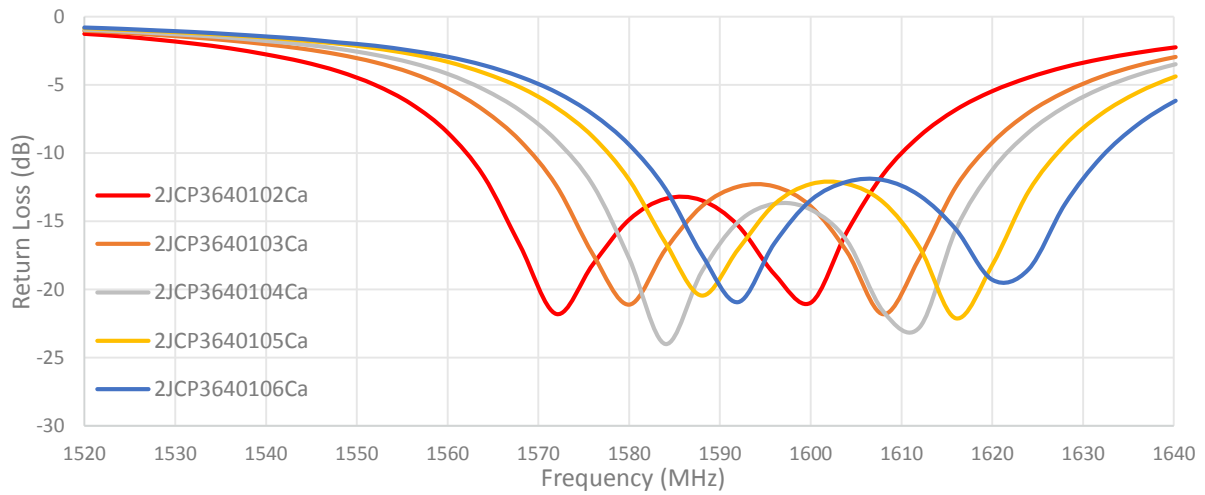
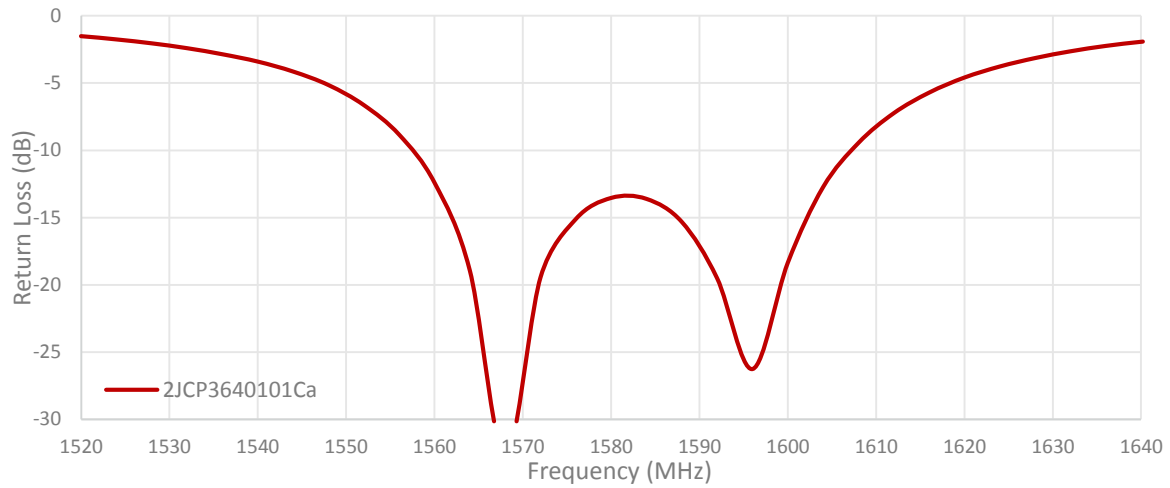

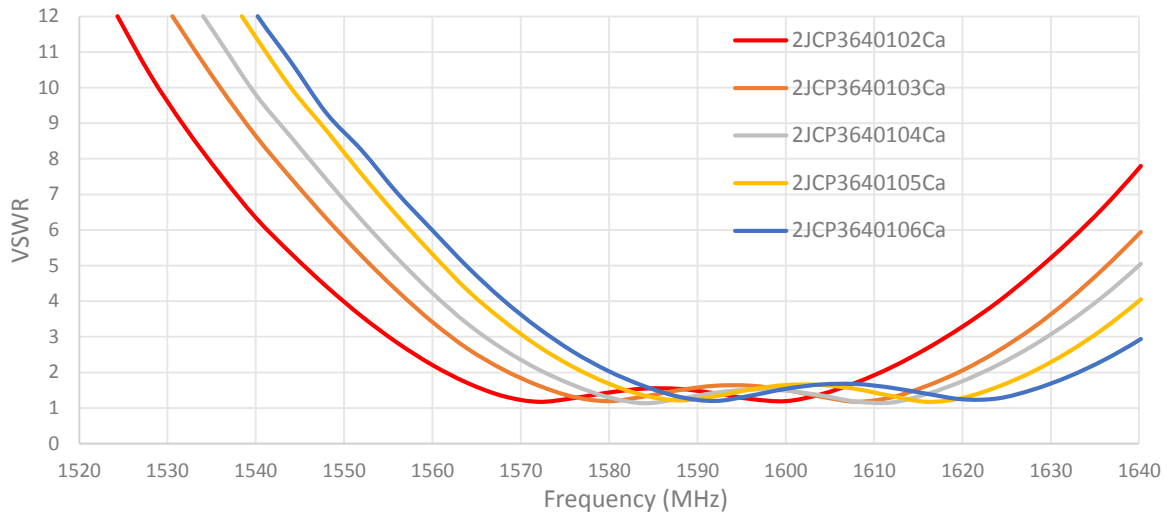
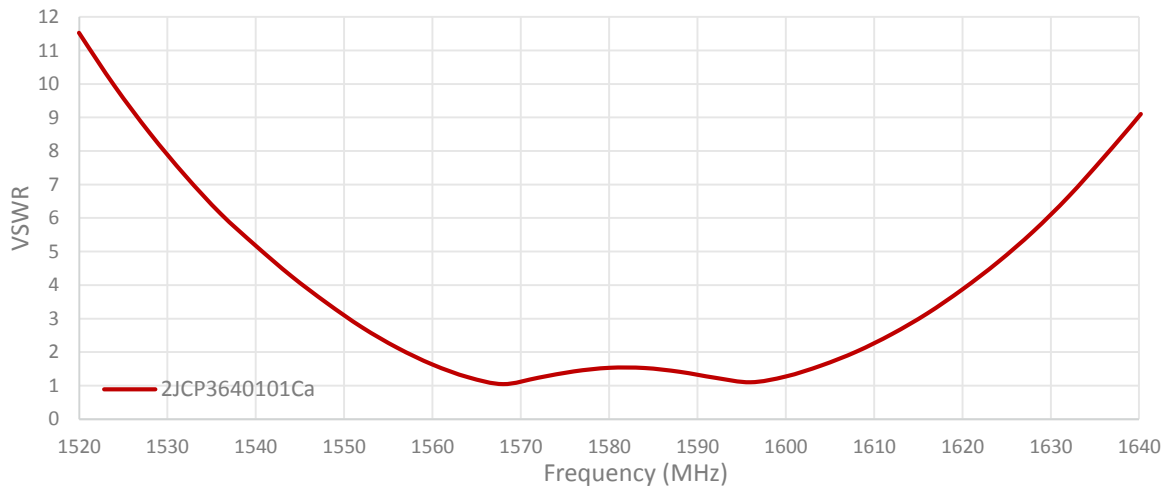

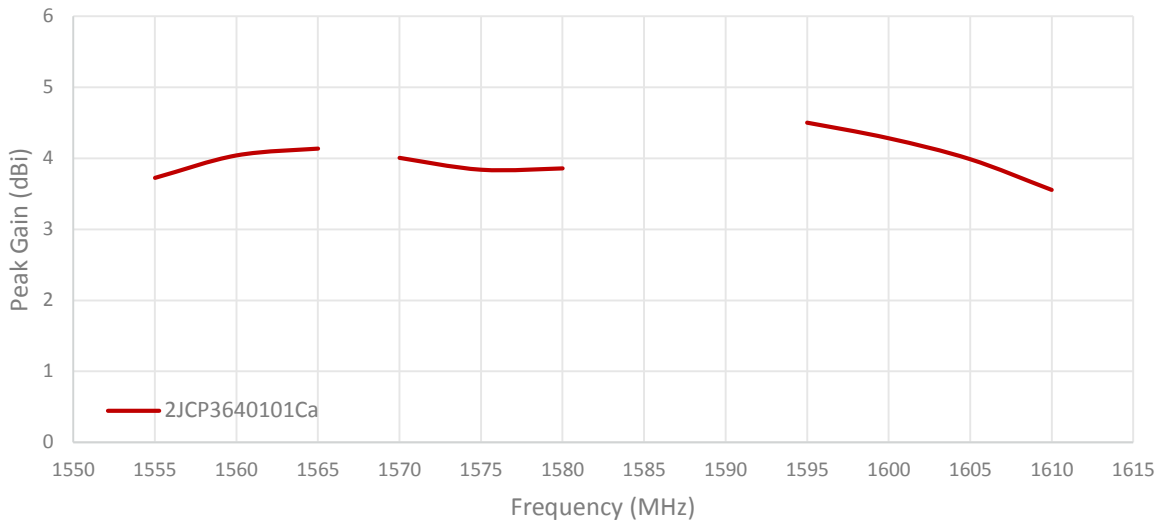
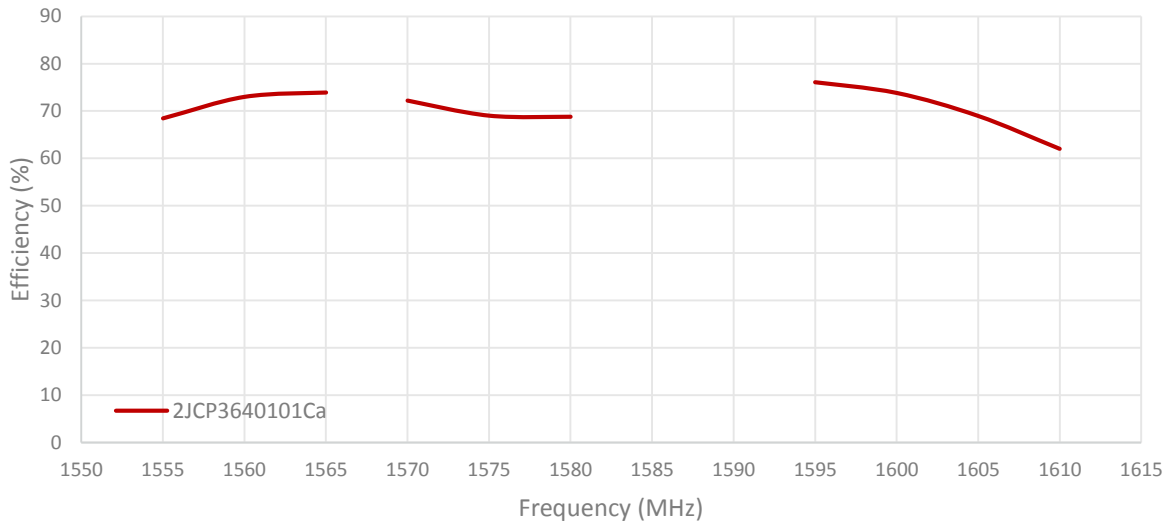

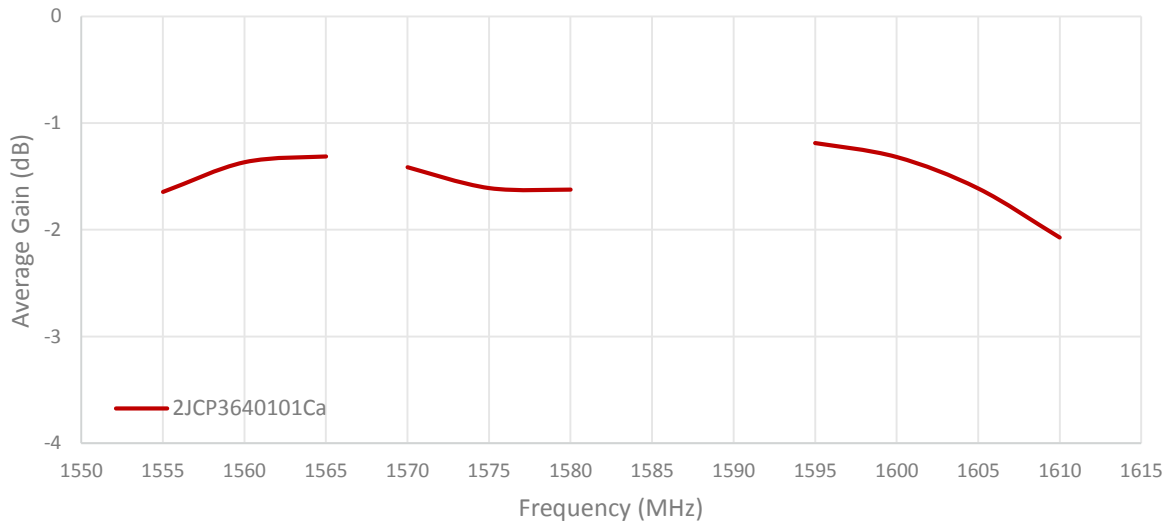

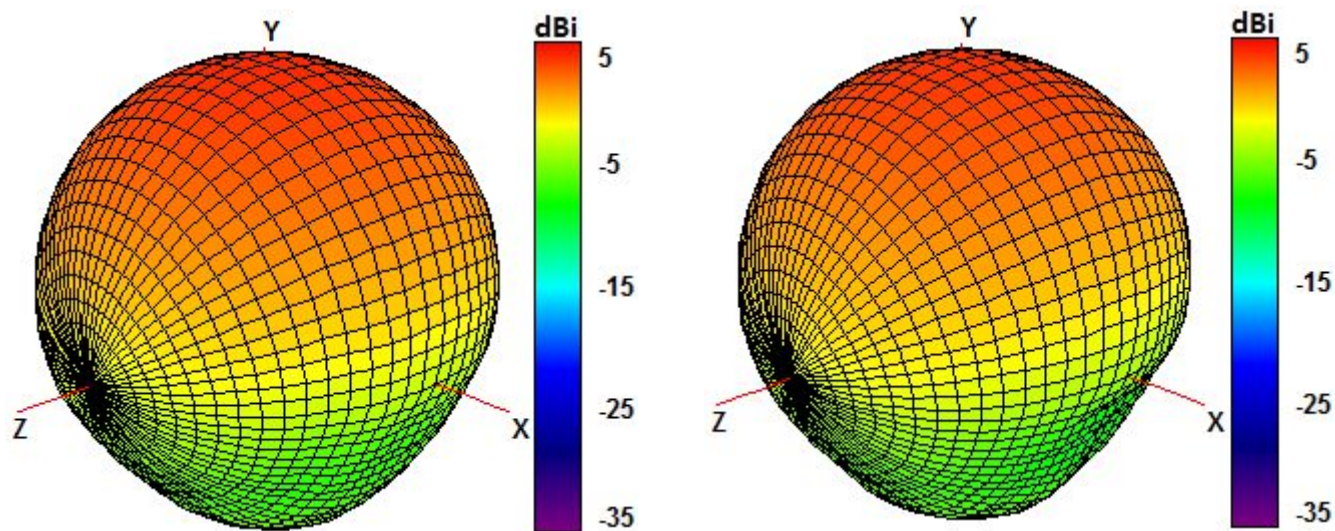

1561 and 1575 MHz Radiation pattern

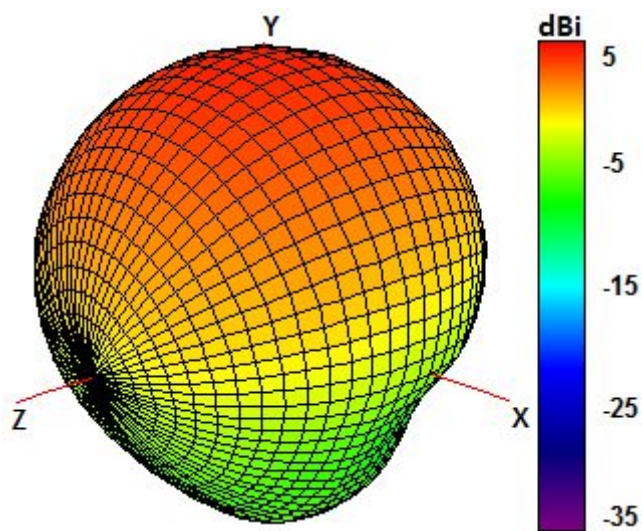

1602 MHz Radiation pattern

## 4. Antenna drawings

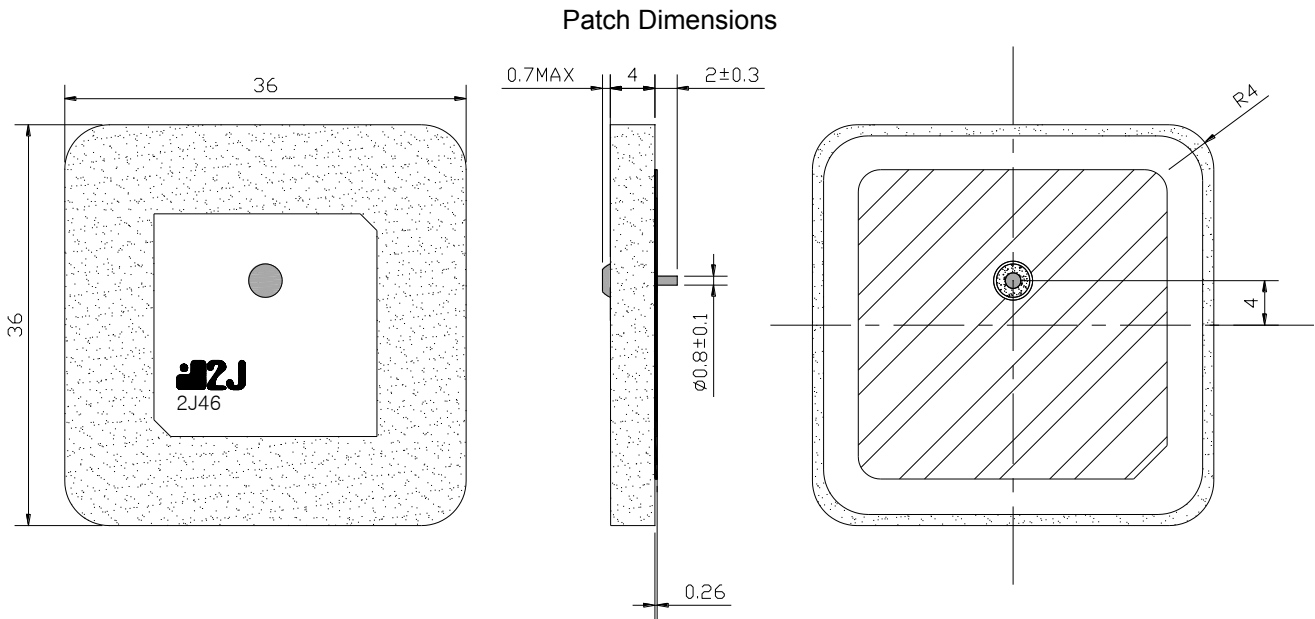

**Layout for top layer**

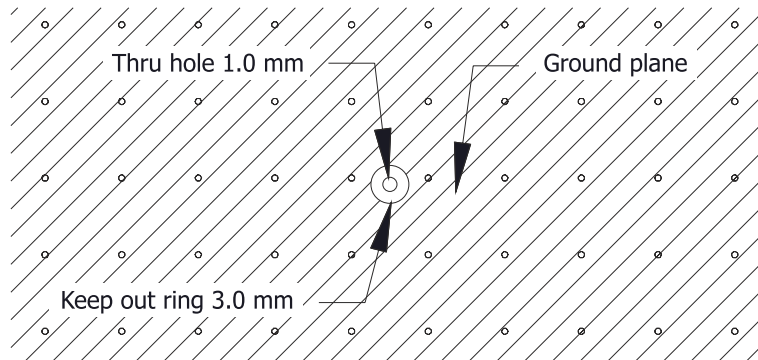

**Layout for bottom layer**

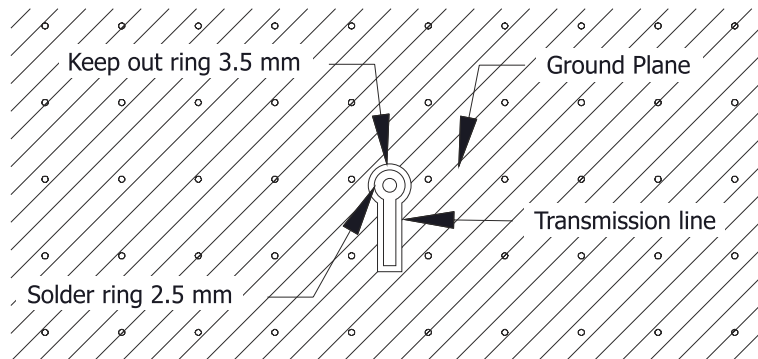



2JDB0803 Development board

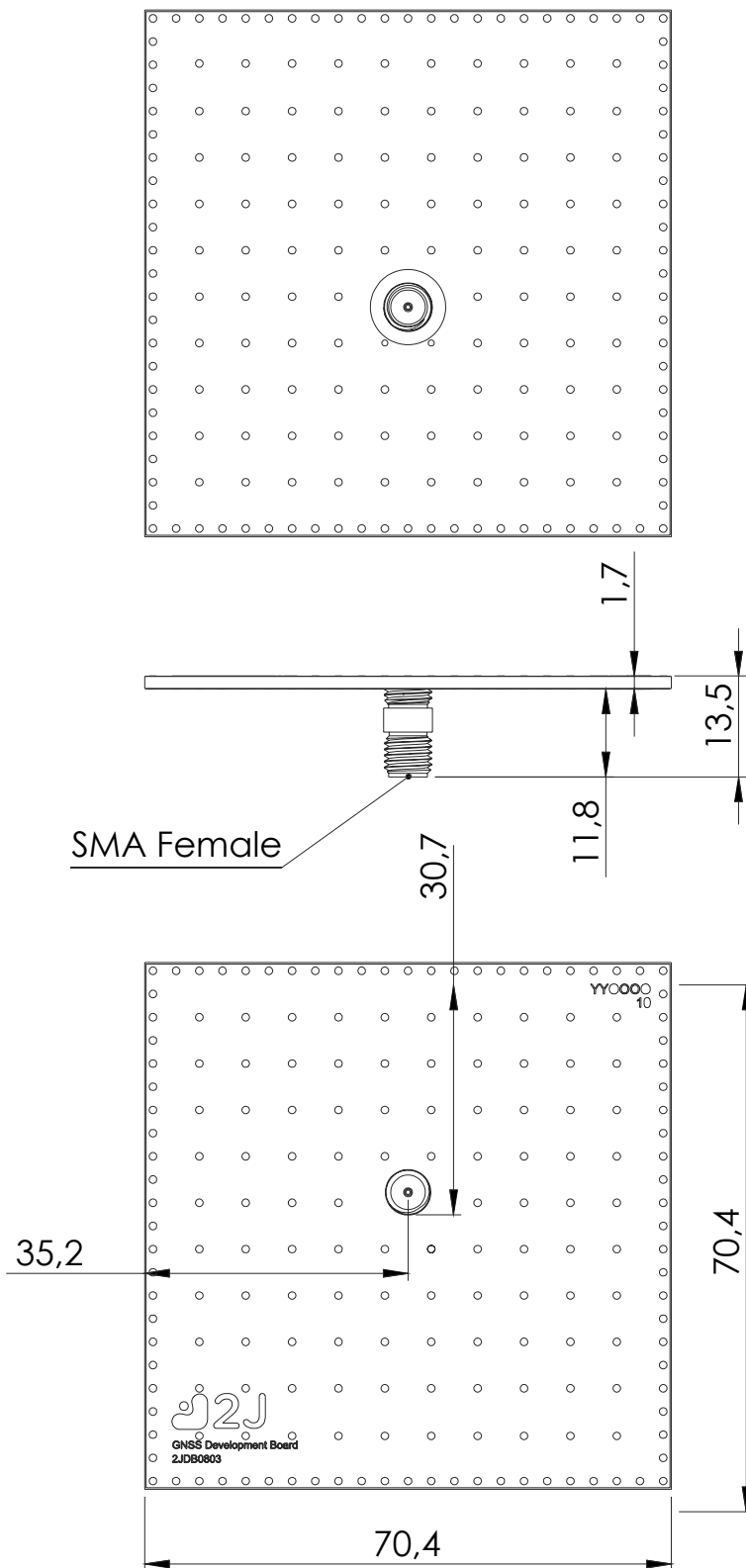

## 5. Antenna Images

