

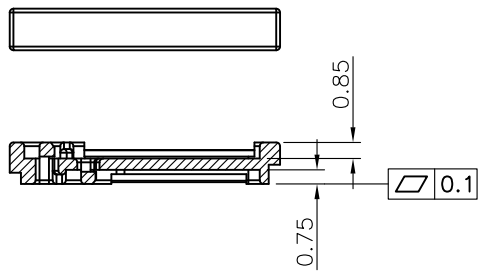

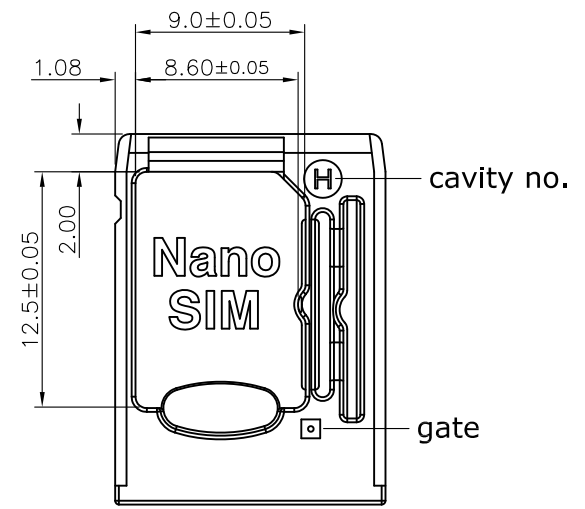

REV.	DESCRIPTION	DRAWN	DATE
1	INITIAL RELEASE	FROS	2024/01/08

- NOTE:
1. MATERIAL: PBT 4130, UL 94V-0, Black
  2. Operating temperature: -40 to +105°C
  3. Packaging: 450pcs/bag

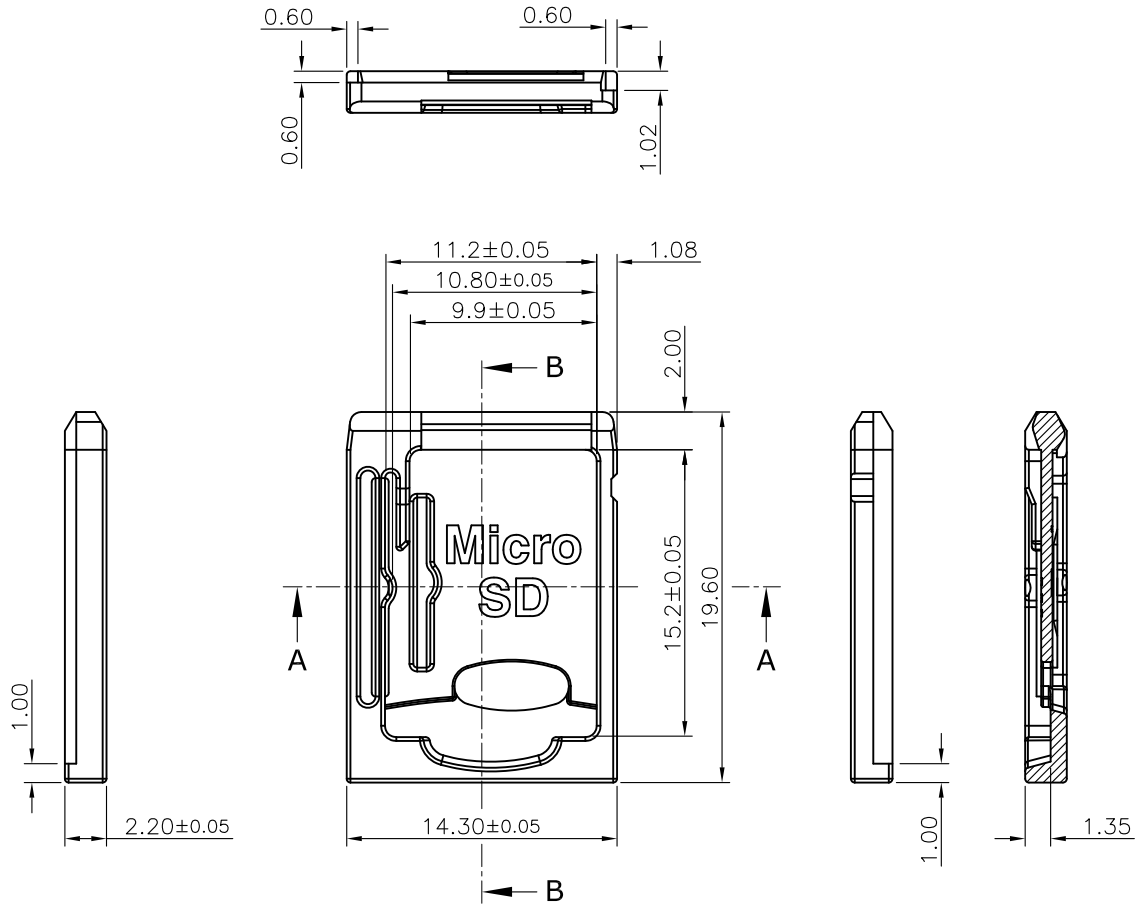

UNLESS OTHERWISE SPECIFIED TOLERANCE					
UNIT:	DECIMAL	LINEAR	ANGLES		
mm	X.	±0.50	±5°	DRAWN NAME: Card Tray, Micro SD & Nano SIM, PBT, Black, Bag, 19.6mm	
	X,X	±0.25	±3°		
	X,XX	±0.12	±1°		
DRAWN	Fros	2024/01/08	DRAWN NAME:		
CHECKED	Tim	2024/01/08	PRODUCT NO. 115U-T009		
APPROVED	Ken	2024/01/08	FILE NAME 115U-T009_B_1		
 SCALE 2.5/1		 SHEET 1/1	 SIZE A4		