

DFK-PC 4/ 8-G-7,62-FS4,8 - Feed-through header



1861219

<https://www.phoenixcontact.com/pc/products/1861219>

Please be informed that the data shown in this PDF document is generated from our online catalog. Please find the complete data in the user documentation. Our general terms of use for downloads are valid.



Feed-through header, nominal cross section: 4 mm², color: green, nominal current: 15 A, rated voltage (III/2): 400 V, contact surface: Sn, contact connection type: Pin, number of potentials: 8, number of rows: 1, number of positions: 8, number of connections: 8, product range: DFK-PC 4/..-G -FS4,8, pitch: 7.62 mm, connection method: Spade connection, mounting: Direct mounting, number of solder pins per potential: 1, plug-in system: COMBICON PC 4, Pin connector pattern alignment: Standard, locking: without, mounting: without, type of packaging: packed in cardboard

Your advantages

- Space-saving, standardized slip-on connection allows worldwide use
- Cable connection on the inside of the device enables flexible positioning of the panel feed-through

Commercial data

Item number	1861219
Packing unit	50 pc
Minimum order quantity	1 pc
Product key	AADWAA
Catalog page	Page 519 (C-1-2013)
GTIN	4017918125738
Weight per piece (including packing)	18.9 g
Weight per piece (excluding packing)	17.787 g
Customs tariff number	85366990
Country of origin	PL

DFK-PC 4/ 8-G-7,62-FS4,8 - Feed-through header



1861219

<https://www.phoenixcontact.com/pc/products/1861219>

Technical data

Product properties

Product type	Feed-through header
Product family	DFK-PC 4/..-G -FS4,8
Product line	COMBICON Connectors L
Type	Feed-through header
Number of positions	8
Pitch	7.62 mm
Number of connections	8
Number of rows	1
Number of potentials	8
Mounting flange	without
Solder pins per potential	1

Data management status

Article revision	01
------------------	----

Electrical properties

Nominal current I_N	15 A
Nominal voltage U_N	400 V
Rated voltage (III/3)	400 V
Rated surge voltage (III/3)	6 kV
Rated voltage (III/2)	400 V
Rated surge voltage (III/2)	6 kV
Rated voltage (II/2)	800 V
Rated surge voltage (II/2)	6 kV

Mounting

Mounting type	Direct mounting
---------------	-----------------

Material specifications

Material data - contact

Note	WEEE/RoHS-compliant, free of whiskers according to IEC 60068-2-82/JEDEC JESD 201
Contact material	Cu alloy
Surface characteristics	Tin-plated
Metal surface contact area (top layer)	Tin (5 - 10 μm Sn)
Metal surface contact area (middle layer)	Nickel (2 - 5 μm Ni)
Metal surface soldering area (top layer)	Tin (5 - 7 μm Sn)
Metal surface soldering area (middle layer)	Nickel (2 - 3 μm Ni)

Material data - housing

Color (Housing)	green (6021)
-----------------	--------------

DFK-PC 4/ 8-G-7,62-FS4,8 - Feed-through header



1861219

<https://www.phoenixcontact.com/pc/products/1861219>

Insulating material	PA
Insulating material group	I
CTI according to IEC 60112	600
Flammability rating according to UL 94	V2

Notes

Notes on operation	In accordance with IEC 61984, COMBICON connectors have no switching power (COC). During designated use, they must not be plugged in or disconnected when carrying voltage or under load.
--------------------	--

Dimensions

Dimensional drawing	
Pitch	7.62 mm
Width [w]	76.18 mm
Height [h]	14.3 mm
Length [l]	37.35 mm
Installed height	14.3 mm
Pin dimensions	0.8 x 4.8 mm

Electrical tests

Air clearances and creepage distances |

Specification	IEC 60664-1:2007-04
Insulating material group	I
Comparative tracking index (IEC 60112)	CTI 600
Rated insulation voltage (III/3)	400 V
Rated surge voltage (III/3)	6 kV
minimum clearance value - non-homogenous field (III/3)	5.5 mm
minimum creepage distance (III/3)	5.5 mm
Rated insulation voltage (III/2)	400 V
Rated surge voltage (III/2)	6 kV
minimum clearance value - non-homogenous field (III/2)	5.5 mm
minimum creepage distance (III/2)	5.5 mm
Rated insulation voltage (II/2)	800 V
Rated surge voltage (II/2)	6 kV
minimum clearance value - non-homogenous field (II/2)	5.5 mm
minimum creepage distance (II/2)	5.5 mm

Environmental and real-life conditions

Ambient conditions

DFK-PC 4/ 8-G-7,62-FS4,8 - Feed-through header



1861219

<https://www.phoenixcontact.com/pc/products/1861219>

Ambient temperature (operation)	-40 °C ... 100 °C (dependent on the derating curve)
Ambient temperature (storage/transport)	-40 °C ... 70 °C
Relative humidity (storage/transport)	30 % ... 70 %
Ambient temperature (assembly)	-5 °C ... 100 °C

Packaging specifications

Type of packaging	packed in cardboard
-------------------	---------------------

Packaging specifications

Type of packaging	packed in cardboard
-------------------	---------------------

1861219

<https://www.phoenixcontact.com/pc/products/1861219>

Drawings

Dimensional drawing

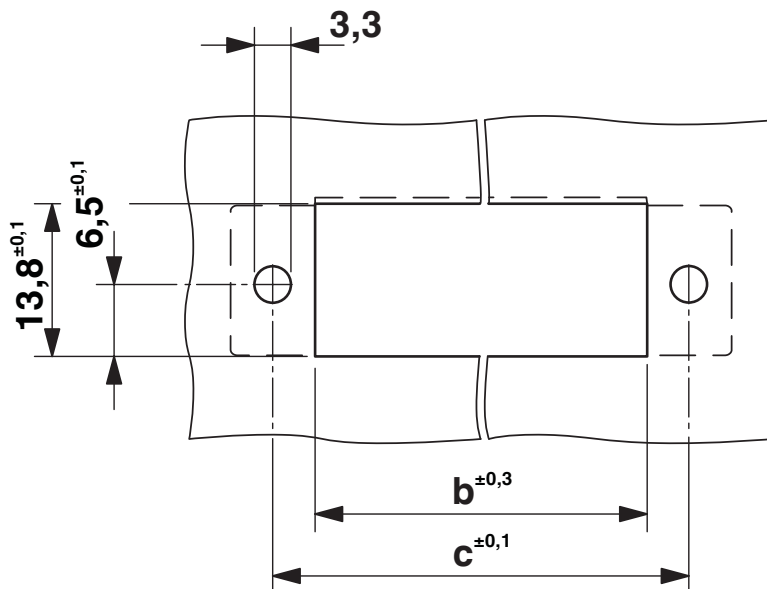

Dimension b = 60.91 mm; dimension c = 68.58 mm

Diagram

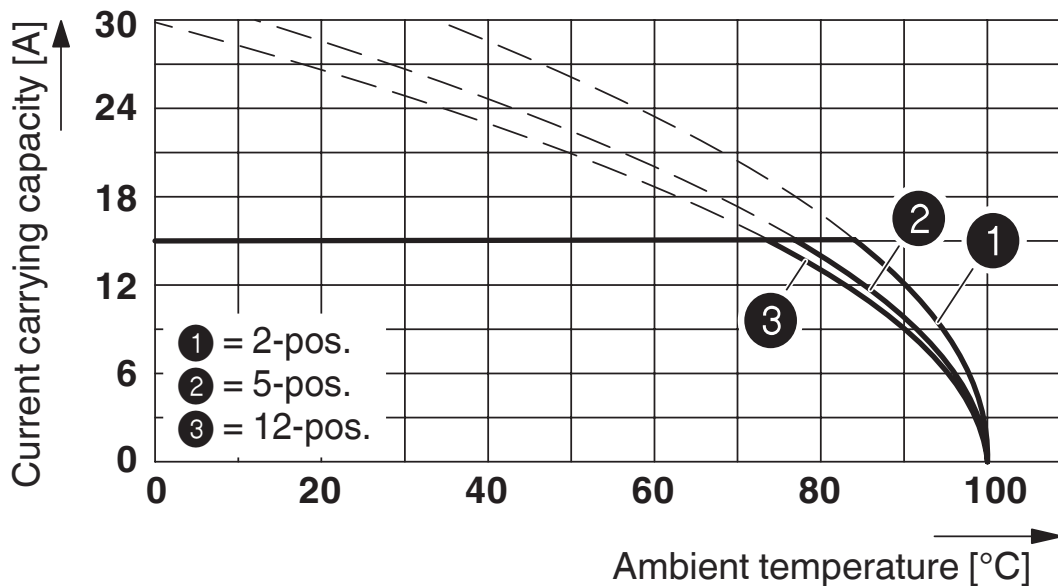

Derating curve for: PC 4/...-ST-7,62 with DFK-PC 4/...-G-7,62-FS4,8

DFK-PC 4/ 8-G-7,62-FS4,8 - Feed-through header





1861219

<https://www.phoenixcontact.com/pc/products/1861219>

Approvals

To download certificates, visit the product detail page: <https://www.phoenixcontact.com/pc/products/1861219>

 cULus Recognized Approval ID: E60425-19920722				
	Nominal voltage U_N	Nominal current I_N	Cross section AWG	Cross section mm^2
Use group B				
For 600 V applications, additional insulation is required on the solder pins	300 V	20 A	-	-
Use group C				
For 600 V applications, additional insulation is required on the solder pins	300 V	20 A	-	-

 CSA Approval ID: 13631				
	Nominal voltage U_N	Nominal current I_N	Cross section AWG	Cross section mm^2
Use group B				
	300 V	20 A	-	-
Use group C				
	300 V	20 A	-	-

DFK-PC 4/ 8-G-7,62-FS4,8 - Feed-through header



1861219

<https://www.phoenixcontact.com/pc/products/1861219>

Classifications

ECLASS

ECLASS-11.0	27460201
ECLASS-12.0	27460201
ECLASS-13.0	27460201

ETIM

ETIM 9.0	EC002637
----------	----------

UNSPSC

UNSPSC 21.0	39121400
-------------	----------

1861219

<https://www.phoenixcontact.com/pc/products/1861219>

Environmental product compliance

EU RoHS

Fulfills EU RoHS substance requirements	Yes, No exemptions
---	--------------------

China RoHS

Environment friendly use period (EFUP)	EFUP-E
	No hazardous substances above the limits

EU REACH SVHC

REACH candidate substance (CAS No.)	No substance above 0.1 wt%
-------------------------------------	----------------------------

EF3.0 Climate Change

CO2e kg	0.261 kg CO2e
---------	---------------

DFK-PC 4/ 8-G-7,62-FS4,8 - Feed-through header



1861219

<https://www.phoenixcontact.com/pc/products/1861219>

Accessories

DFK-MSTB-SS - Screw set

0708263

<https://www.phoenixcontact.com/pc/products/0708263>



Screw set, for securing the header to the device wall, consists of an M3 x 10 screw, with a spring washer and a nut

CP-PC RD - Coding profile

1701967

<https://www.phoenixcontact.com/pc/products/1701967>



Coding profile, for plugging into the coding ribs of the plug at a later date, insulating material, color: Red

DFK-PC 4/ 8-G-7,62-FS4,8 - Feed-through header

1861219

<https://www.phoenixcontact.com/pc/products/1861219>



SK 7,62/3,8:FORTL.ZAHLEN - Marker card

0804549

<https://www.phoenixcontact.com/pc/products/0804549>

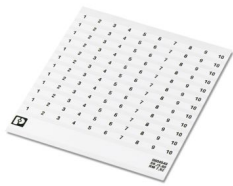

Marker card, white, labeled, horizontal: consecutive numbers 1 ... 10, 11 ... 20, etc. up to 91 ... 100, mounting type: adhesive, for terminal block width: 7.62 mm, text field height: 3.8 mm, text field width: 7.62 mm

SZS 0,6X3,5 - Screwdriver

1205053

<https://www.phoenixcontact.com/pc/products/1205053>



Actuation tool, for ST terminal blocks, insulated, also suitable for use as a bladed screwdriver, size: 0.6 x 3.5 x 100 mm, 2-component grip, with non-slip grip

DFK-PC 4/ 8-G-7,62-FS4,8 - Feed-through header



1861219

<https://www.phoenixcontact.com/pc/products/1861219>

SK 3,8 REEL P7,62 WH CUS - Marker card

0825128

<https://www.phoenixcontact.com/pc/products/0825128>

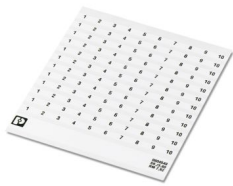

Marker card, can be ordered: by card, white, labeled according to customer specifications, mounting type: adhesive, for terminal block width: 7.62 mm

SK U/3,8 WH:UNBEDRUCKT - Marker card

0803906

<https://www.phoenixcontact.com/pc/products/0803906>



Marker card, Din A4, white, unlabeled, can be labeled with: PLOTMARK, CMS-P1-PLOTTER, Office printing systems, mounting type: adhesive, for terminal block width: 210 mm, Number of individual labels: 1440, text field height: 3.8 mm, text field width: 186 mm

DFK-PC 4/ 8-G-7,62-FS4,8 - Feed-through header



1861219

<https://www.phoenixcontact.com/pc/products/1861219>

SK 3,8 WH:REEL - Marker strip

0805218

<https://www.phoenixcontact.com/pc/products/0805218>



Marker strip, Roll, white, unlabeled, can be labeled with: THERMOMARK E.300 (D)/600 (D), THERMOMARK ROLL 2.0, THERMOMARK ROLL, THERMOMARK ROLL X1, THERMOMARK ROLLMASTER 300/600, THERMOMARK X1.2, mounting type: adhesive, Number of individual labels: 12, text field height: 3.8 mm, text field width: 90000 mm

C-SCF 1,5/4,8X0,8 - Connector

3240155

<https://www.phoenixcontact.com/pc/products/3240155>



Slip-on sleeve, non-insulated, 0.75 ... 1.5 mm², 4.8 x 0.8

DFK-PC 4/ 8-G-7,62-FS4,8 - Feed-through header

1861219

<https://www.phoenixcontact.com/pc/products/1861219>

C-SCFI 1,5/4,8X0,8 - Connector

3240051

<https://www.phoenixcontact.com/pc/products/3240051>



Slip-on sleeve, red, 0.5 ... 1.5 mm², 4.8 x 0.8

C-SCFFI 1,5/4,8X0,8 - Connector

3240537

<https://www.phoenixcontact.com/pc/products/3240537>



Slip-on sleeve, fully isolated, red, 0.5 ... 1.5 mm², for plug 4.8 x 0.8 mm

DFK-PC 4/ 8-G-7,62-FS4,8 - Feed-through header



1861219

<https://www.phoenixcontact.com/pc/products/1861219>

C-SCF 2,5/4,8X0,8 - Connector

3240158

<https://www.phoenixcontact.com/pc/products/3240158>



Slip-on sleeve, non-insulated, 1.5 ... 2.5 mm², 4.8 x 0.8

C-SCFI 2,5/4,8X0,8 - Connector

3240054

<https://www.phoenixcontact.com/pc/products/3240054>



Slip-on sleeve, blue, 1.5 ... 2.5 mm², 4.8 x 0.8

DFK-PC 4/ 8-G-7,62-FS4,8 - Feed-through header

1861219

<https://www.phoenixcontact.com/pc/products/1861219>

C-SCFFI 2,5/4,8X0,8 - Connector

3240540

<https://www.phoenixcontact.com/pc/products/3240540>



Slip-on sleeve, fully isolated, blue, 1.5 ... 2.5 mm², for plug 4.8 x 0.8 mm

PC 4/ 8-ST-7,62 - PCB connector

1804962

<https://www.phoenixcontact.com/pc/products/1804962>

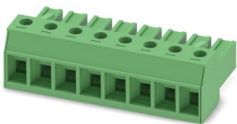

PCB connector, nominal cross section: 4 mm², color: green, nominal current: 20 A, rated voltage (III/2): 630 V, contact surface: Sn, contact connection type: Socket, number of potentials: 8, number of rows: 1, number of positions: 8, number of connections: 8, product range: PC 4/..-ST, pitch: 7.62 mm, connection method: Screw connection with tension sleeve, screw head form: L Slotted, conductor/PCB connection direction: 0 °, locking clip: - Locking clip, plug-in system: COMBICON PC 4, locking: without, mounting: without, type of packaging: packed in cardboard

DFK-PC 4/ 8-G-7,62-FS4,8 - Feed-through header



1861219

<https://www.phoenixcontact.com/pc/products/1861219>

PCC 4/ 8-ST-7,62 - PCB connector

1840133

<https://www.phoenixcontact.com/pc/products/1840133>

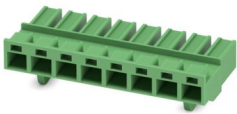

PCB connector, nominal cross section: 4 mm², color: green, nominal current: 20 A, rated voltage (III/2): 1000 V, contact connection type: Socket, number of potentials: 8, number of rows: 1, number of positions: 8, number of connections: 8, product range: PCC 4/..-ST, pitch: 7.62 mm, connection method: Crimp connection, conductor/PCB connection direction: 0 °, locking clip: - Locking clip, plug-in system: COMBICON PC 4, locking: without, mounting: without, type of packaging: packed in cardboard, Corresponding female crimp contacts with current [A] and conductor cross section range [mm²] data: 13,5A/STG-MTN 0,5-1,0 (3190438); 13,5A/STG-MTN 0,5-1,0 BA (3190629); 20A/STG-MTN 1,5-2,5 (3190506); 20A/STG-MTN 1,5-2,5 BA (3190632). BA = Taped contacts

Phoenix Contact 2024 © - all rights reserved

<https://www.phoenixcontact.com>

PHOENIX CONTACT GmbH & Co. KG

Flachsmarktstraße 8

D-32825 Blomberg

+49 (0) 5235-3 00

info@phoenixcontact.com