

## 2JF0883Pa

### 5GNR Flexible Polymer Adhesive Mount

#### Key Features

##### 5GNR

- 617-960 MHz
- 1427-2690 MHz
- 3300-5000 MHz
- 5150-5925 MHz

Self-Adhesive

Ultra Wideband

Smallest Size

Right-Hand Feed

High Performance

Flexible Material

Ground Plane Dependent

Dimensions 50 × 20 × 0.2 mm

Customizable Cable and Connector



**Note:** Antenna integration based on Application Note (page 9 - 17).



## 1. Antenna and electrical specifications

Parameters	5GNR Antenna			
<b>Technologies</b>	5G, 4G, 3G and 2G			
<b>Standards</b>	5GNR/4GLTE/FirstNet/CBRS/LPWA/CAT-X/CAT-Mx/CAT-NBx/NB-IoT/3G/2G			
<b>Frequency (MHz)</b>	617-960	1427-2690	3300-5000	5150-5925
<b>Band (MHz)</b>	600, 700, 850, 900	1500, 1600, 1700, 1800, 1900, 2000, 2100, 2300, 2500, 2600	3300, 3500, 3600, 3700, 4500	5200, 5500, 5800
<b>5GNR Bands</b>	n5, n8, 12, n20, n28, n71, n81, n82, n83,	n1, n2, n3, n7, n25, n34, n38, n39, n40, n41, n50, n51, n66, n70, n74, n75, n76, n80, n84, n86	n77, n78, n79	
<b>4GLTE Bands</b>	B5, B6, B8, B12, B13, B14, B17, B18, B19, B20, B26, B27, B28, B29, B44, B67, B68, B71, B85	B1, B2, B3, B4, B7, B9, B10, B11, B21, B23, B24, B25, B30, B32, B33, B34, B35, B36, B37, B38, B39, B40, B41, B45, B50, B51, B65, B66, B69, B70, B74, B75, B76	B22, B42, B43, B48, B49, B52	B46, B47, B252, B255
<b>3GCELL Bands</b>	B5, B6, B8, B12, B13, B14, B19, B20, B26	B1, B2, B3, B4, B7, B9, B10, B11, B21, B25, B32, B33, B34, B35, B36, B37, B38, B39, B40	B22	
<b>2GCELL Bands</b>	710, 750, 810T, 850, 900P, 900E, 900R	1800DCS, 1900PCS		
<b>CDMACELL Bands</b>	BC0, BC2, BC3, BC7, BC9, BC10, BC12, BC18, BC19	BC1, BC4, BC6, BC8, BC13, BC14, BC15, BC16, BC20, BC21		
<b>Return Loss (dB)</b>	~-5.6	~-6.7	~-7.4	~-7.8
<b>VSWR</b>	~3.6:1	~3.6:1	~2.9:1	~2.6:1
<b>Efficiency (%)</b>	~45.5	~45.7	~45.4	~45.9
<b>Peak Gain (dBi)</b>	~1.3	~0.8	~3.0	~3.0
<b>Average Gain (dB)</b>	~-3.6	~-4.1	~-4.1	~-4.0
<b>Impedance (Ohm)</b>	50			
<b>Polarisation</b>	Linear			
<b>Radiation Pattern</b>	Omni-Directional			
<b>Max. Input Power (W)</b>	25			
<b>Connector Type</b>	U.FL Standard (Other Connectors Available)			
<b>Cable Length</b>	42mm Standard (Other Cable Length Limited - see Application Note)			
<b>Cable Type</b>	1.37mm Mini-Coax Standard (Other Cables Available)			

### Antenna Measurement Conditions:

Mounted on a 120x50 mm Ground Plane

42 mm of 1.37 mm Mini-Coax Cable

Measured in Certified CTIA 3D Anechoic Chamber

## 2. Mechanical and environmental specifications

Specifications	2JF0883Pa
<b>Mounting Type</b>	Adhesive Mount
<b>Dimensions (mm)</b>	50 × 20 × 0.2
<b>Material</b>	Flexible Polymer
<b>Operating Temperature (C)</b>	-40 to +85
<b>Storage Temperature (C)</b>	-40 to +85
<b>Substance Compliance</b>	RoHS

## 3. Antenna parameters

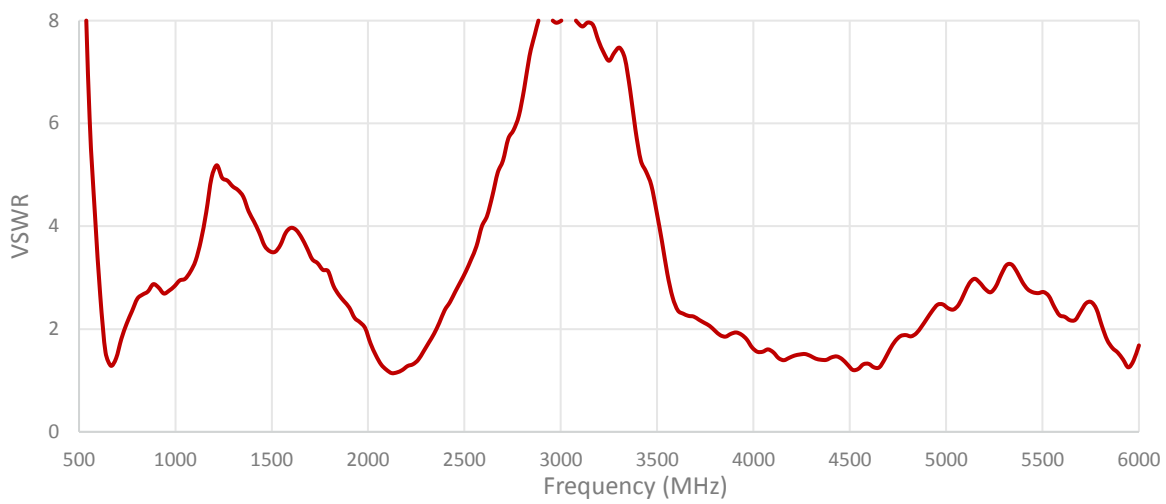
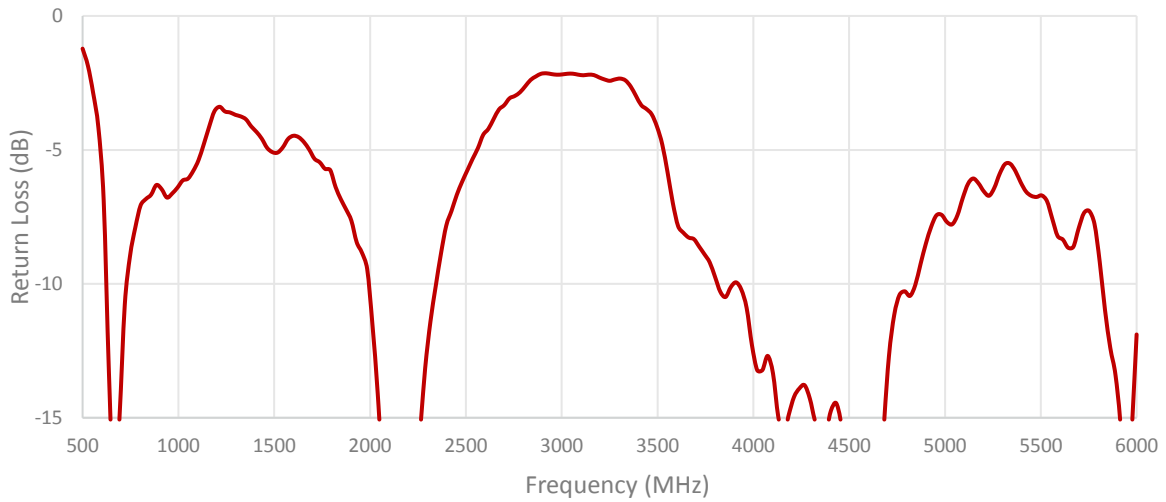

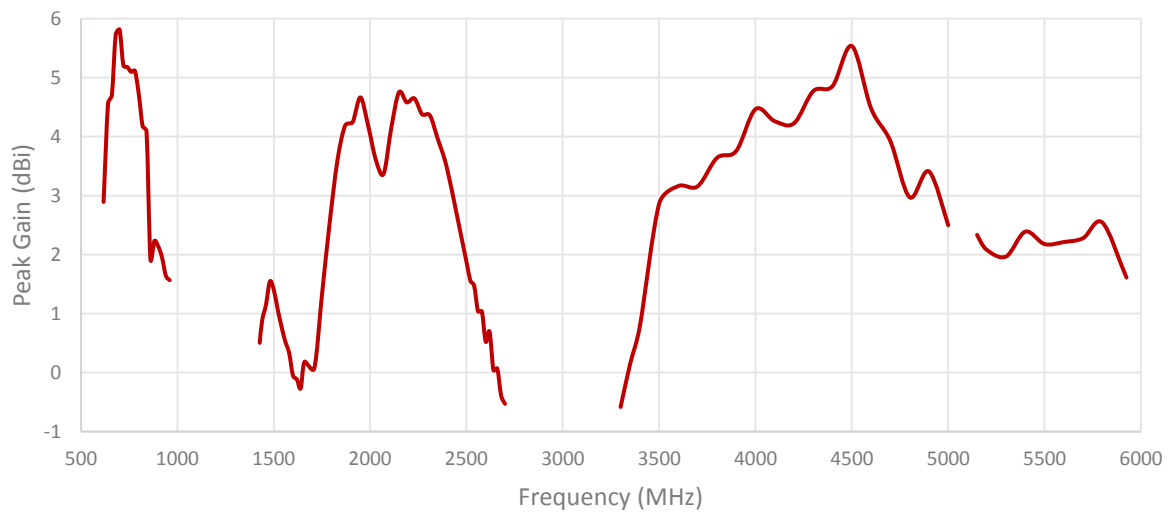
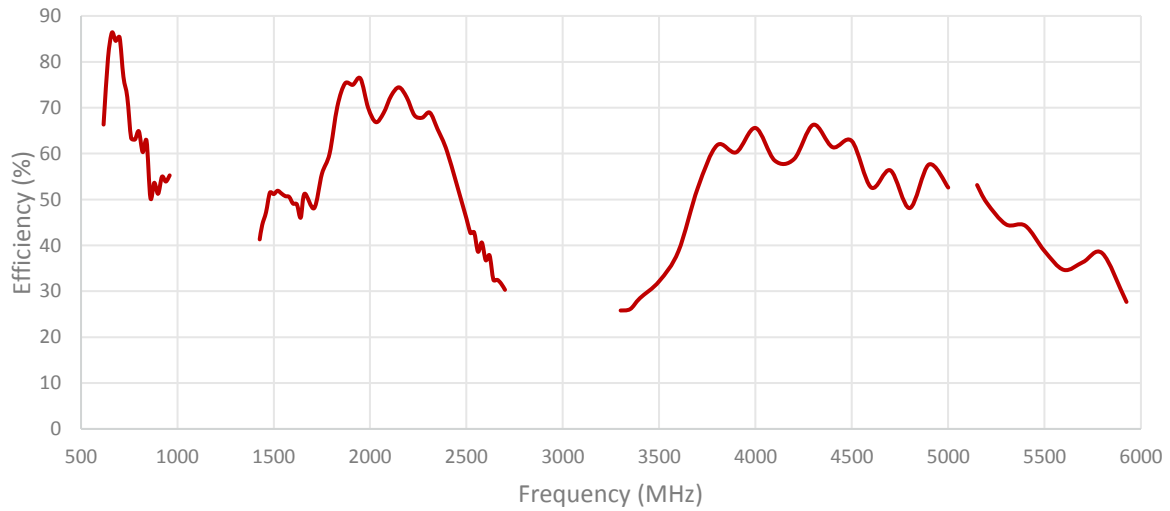

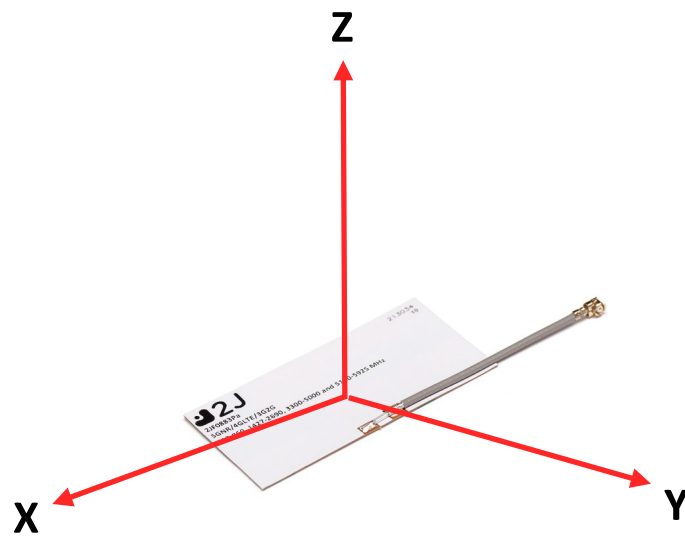
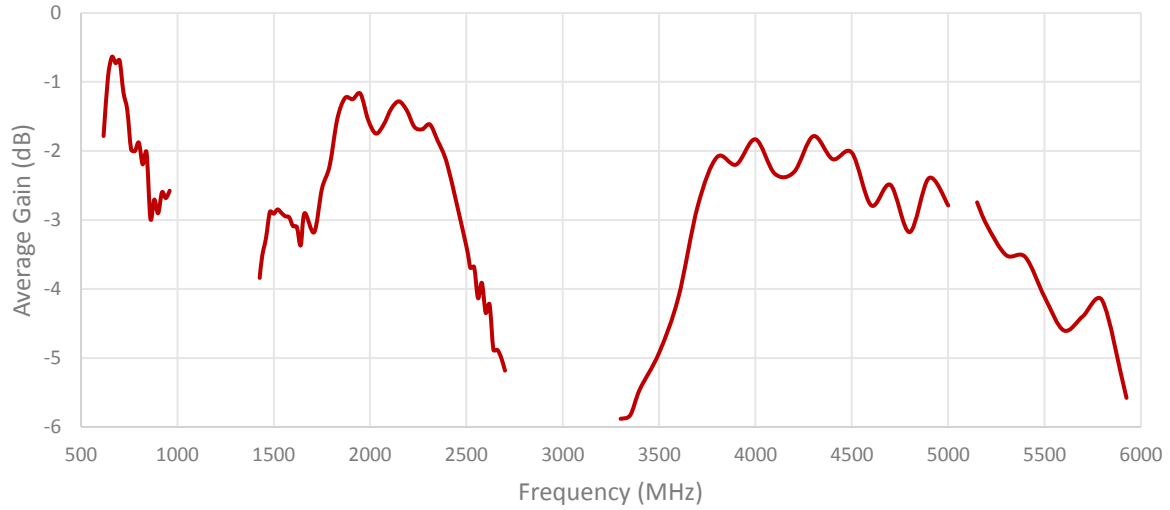

Radiation pattern reference

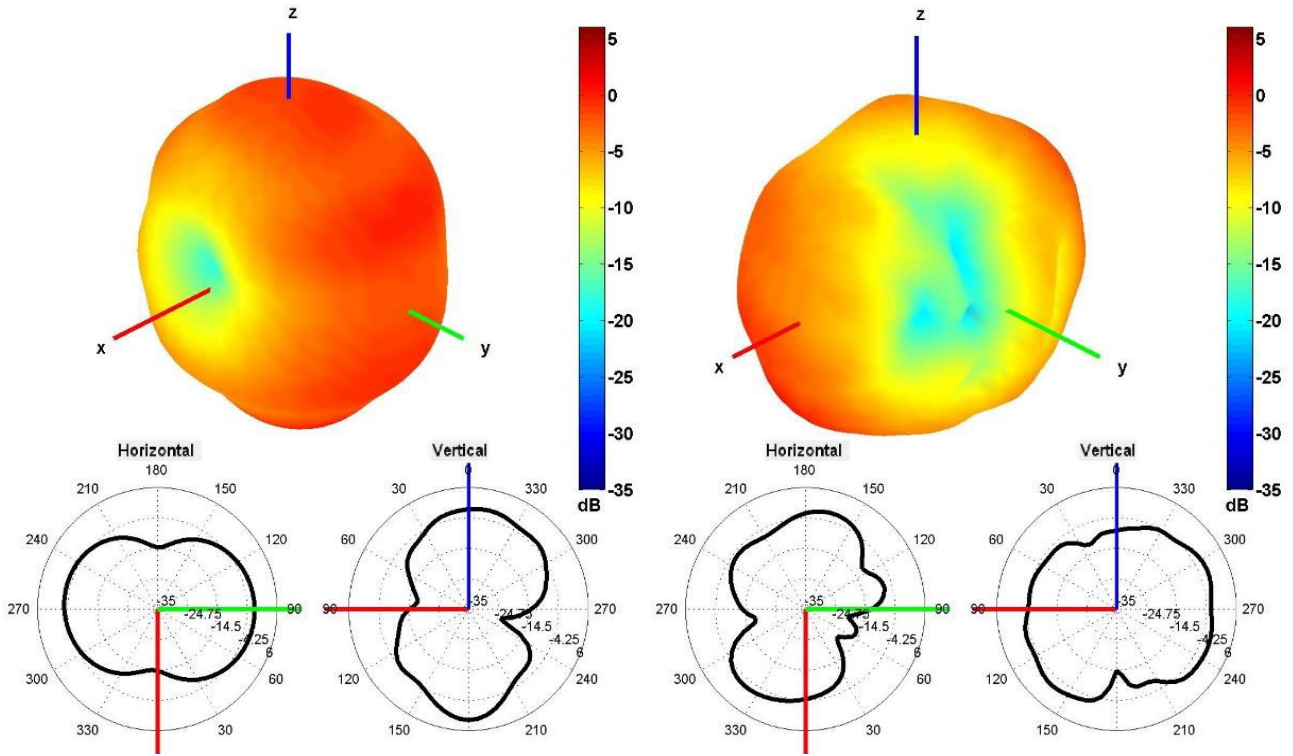

750 and 2500 MHz Radiation pattern

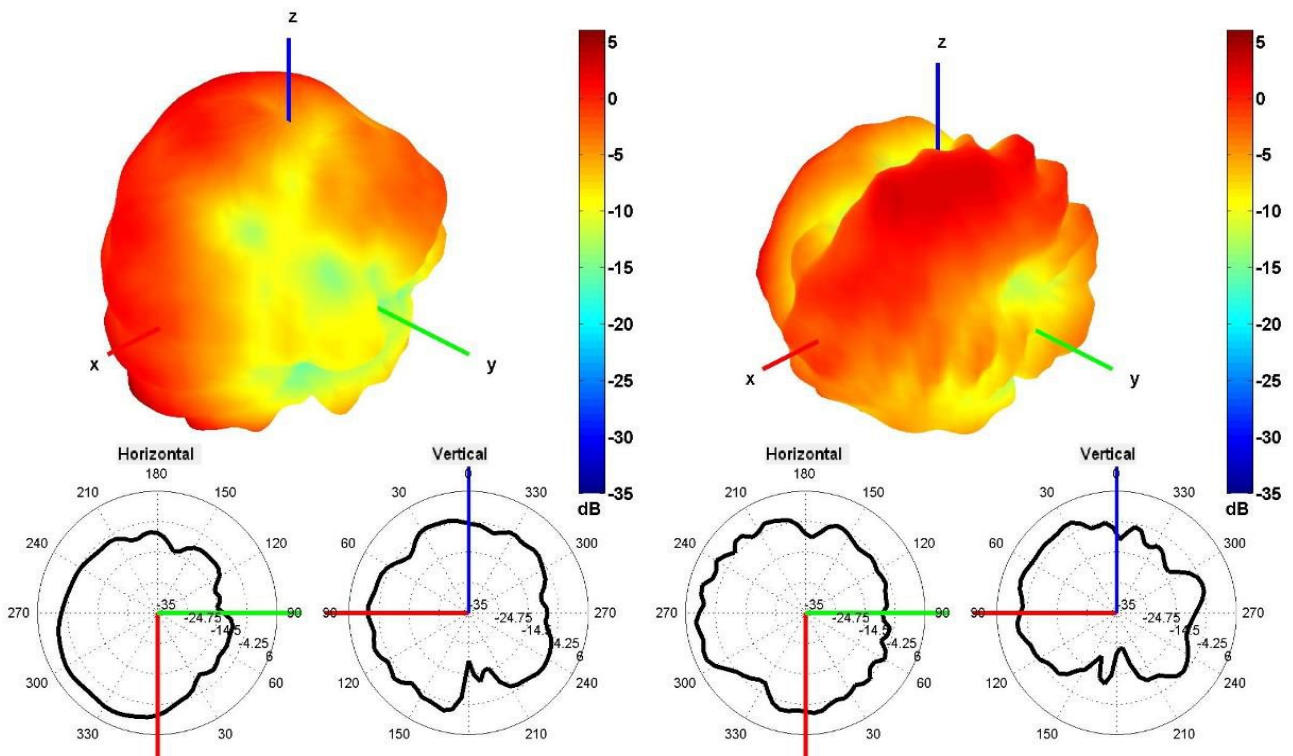

4500 and 5500 MHz Radiation pattern

## 4. Antenna drawings

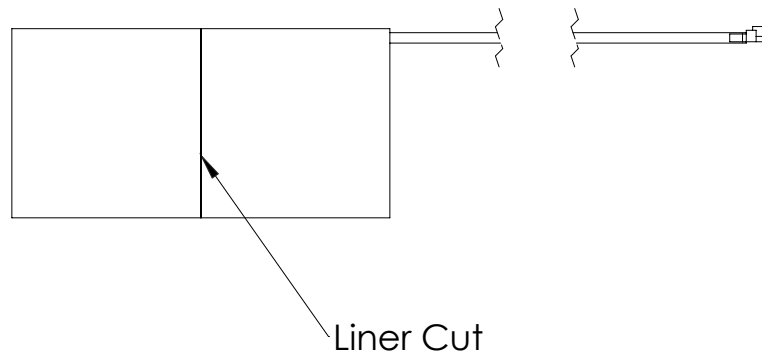
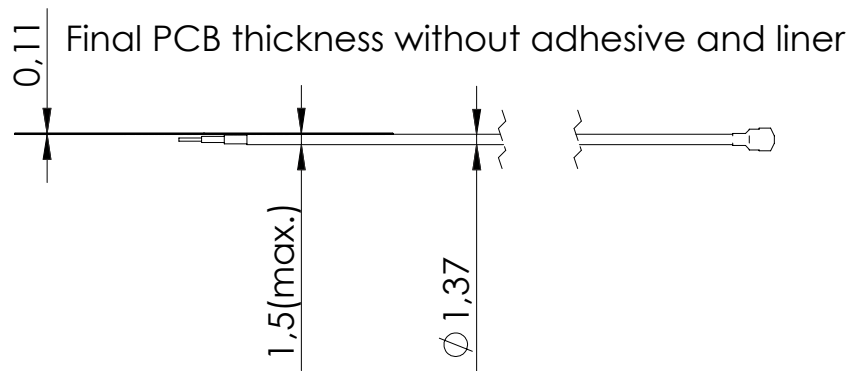
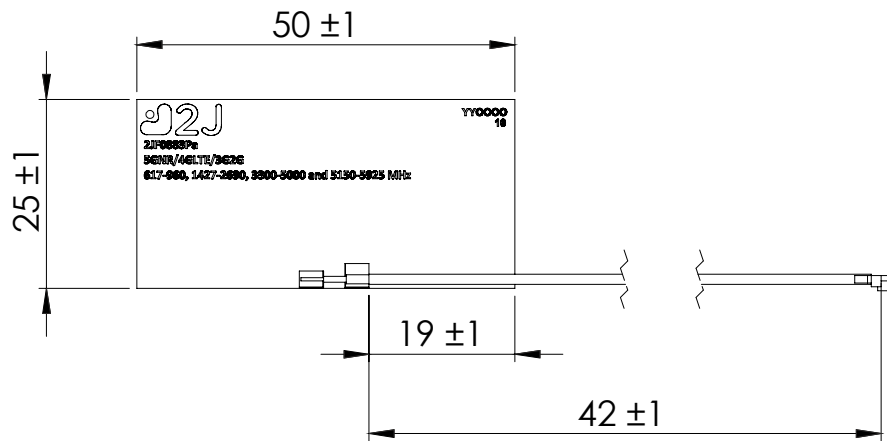



## 5. Application Note

### 2JF0883P and 2JF0883Pa

#### 1./ INTRODUCTION

The "Mono-Flexi" Series of high efficiency antennas introduce a new cable bridging between radiation elements and ground plane extension, making it ideal for small device integration into PCB or cellular devices with complicated size restrictions. This creates a lower resonance and optimizes tuning while keeping the antenna dimensions to a minimum with maximum efficiency, especially across low frequency bands.

Some common applications for this antenna are: Cellular Mobile HD4K Video, Consumer Electronics, Laptops / Tablets, Drones, Small OBDII Tracking Systems, etc.

2JF0883P and 2JF0883Pa are compatible with 5GNR, 4G LTE, 3G and 2G standards, covering 617 MHz – 5925 MHz frequencies. With peak gains up to ~4.1 dBi, this antenna maintains excellent maximum efficiency of ~70% while offering constant and reliable connectivity. This antenna is the newest solution for high voice, data, and internet connectivity necessary for IoT and device to device quality communications.

#### 2./ ANTENNA SELECTION, LOCATION AND ORIENTATION

Depending on the module model and location on the device's PCB, the Left-Handed Feed, or the Right-Handed Feed Antenna (2JF0883P and 2JF0883Pa respectively) should be selected. This is to have the antenna connector closer to the module of the device. We must remember this antenna is different technology and long cable is not possible to use. The second consideration when selecting the antenna is: if the ground plane is of square form factor, we must position the antenna on the corner of the PCB and the cable routing must point outwards of the ground plane. This is to maximize the current distribution on the antenna and the bridging effect on the antenna. Antenna must be mounted on the shortest side of the board when rectangular, if squared, board must be at the corner. See below images.

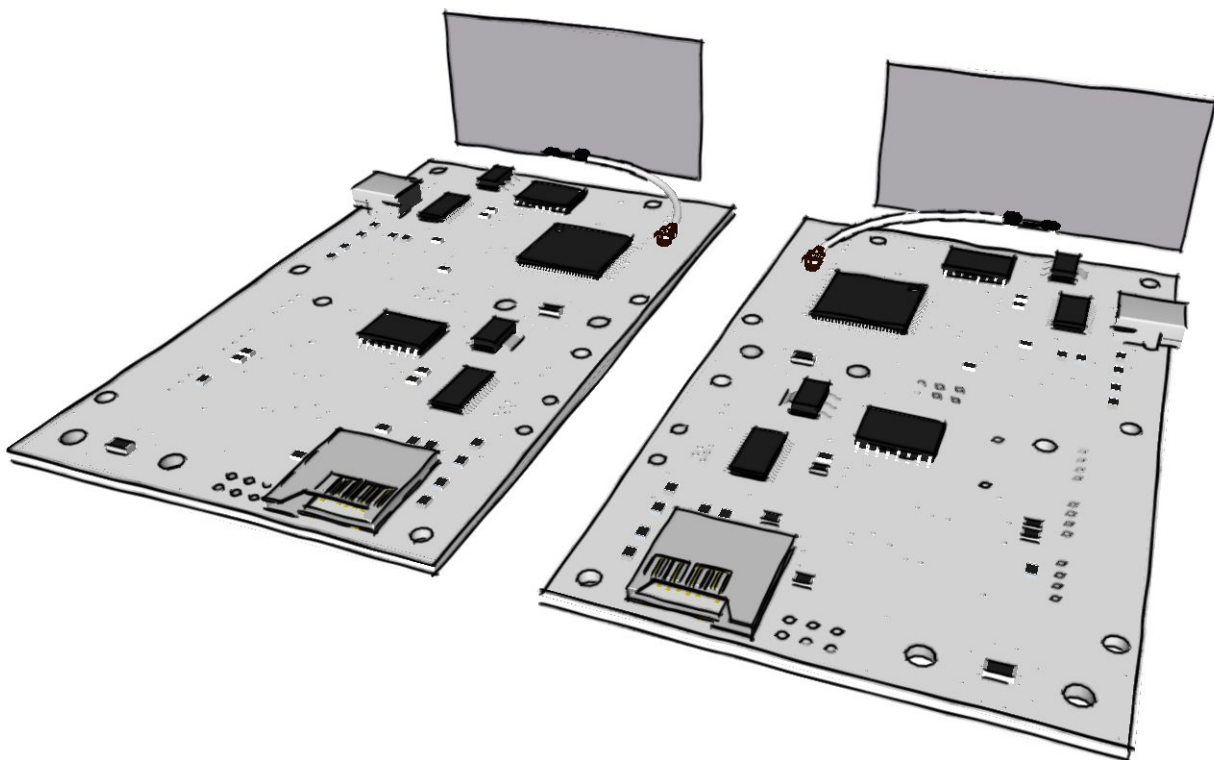

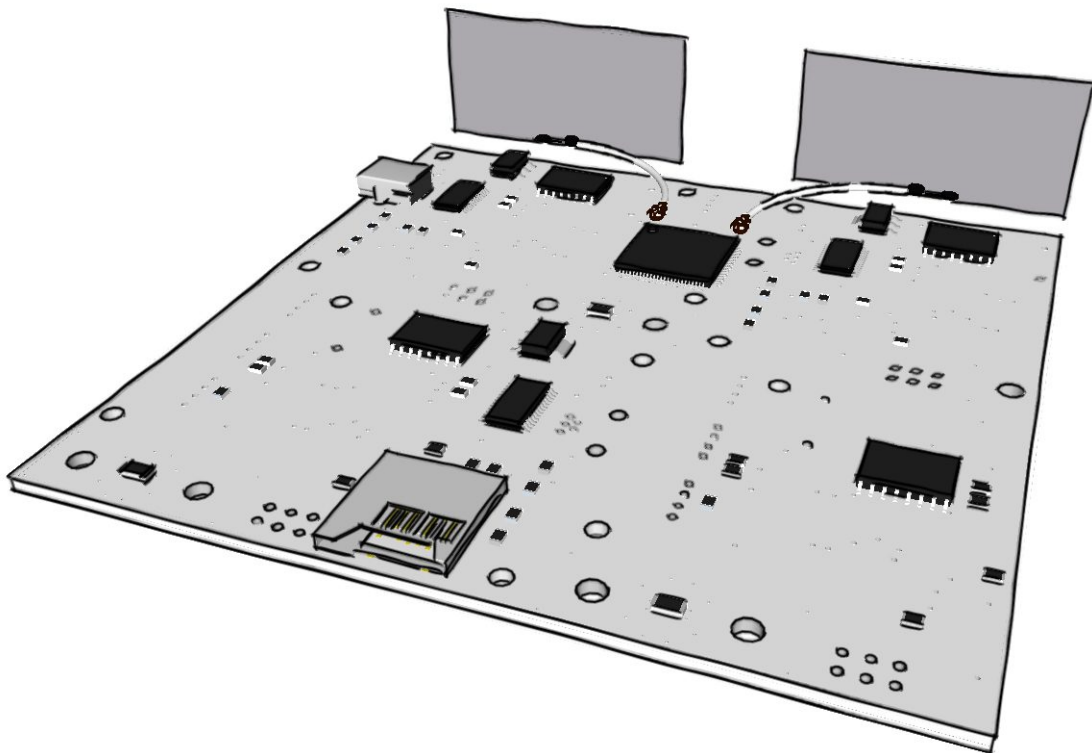
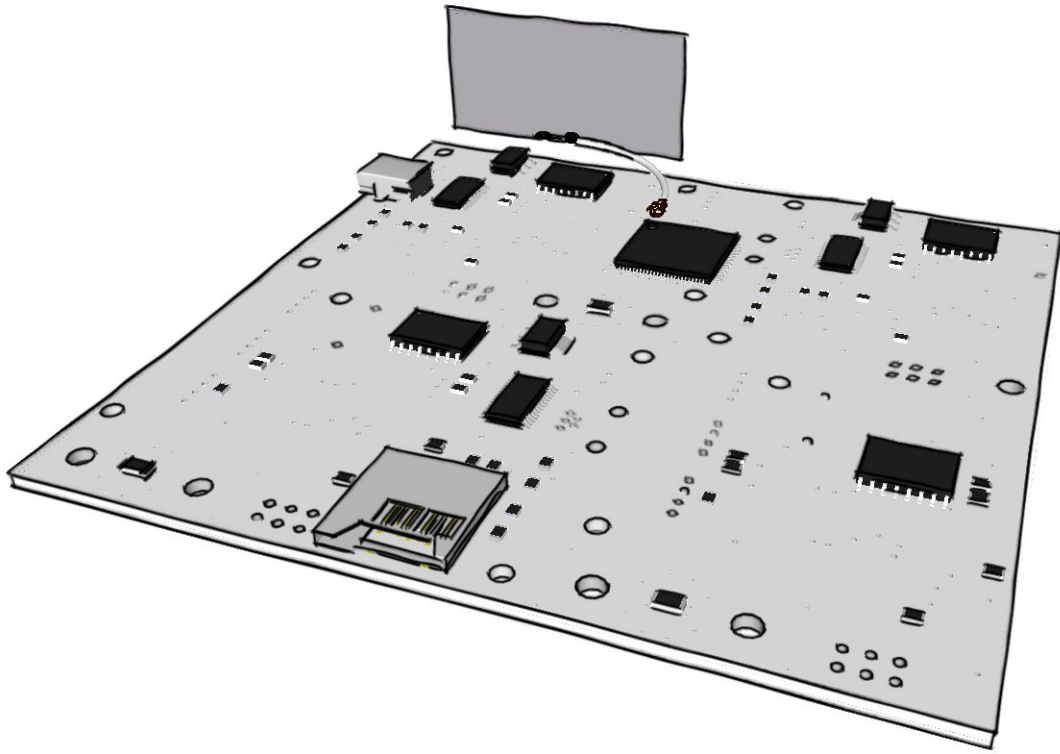

Avoid placing the antennas in front of high-profile metal elements or noisy components such as USB, LAN, power supplies, large inductors, RF connectors, etc. It is essential to keep 10mm distance from the antenna to the edge of the PCB for optimal performance, unless in case by case the distance to ground plane can be reduced to 7mm or increased it up to 15m. The basic rule of thumb for high profile metal objects is to be below the 30 degree line from the edge of the ground plane. See below images.

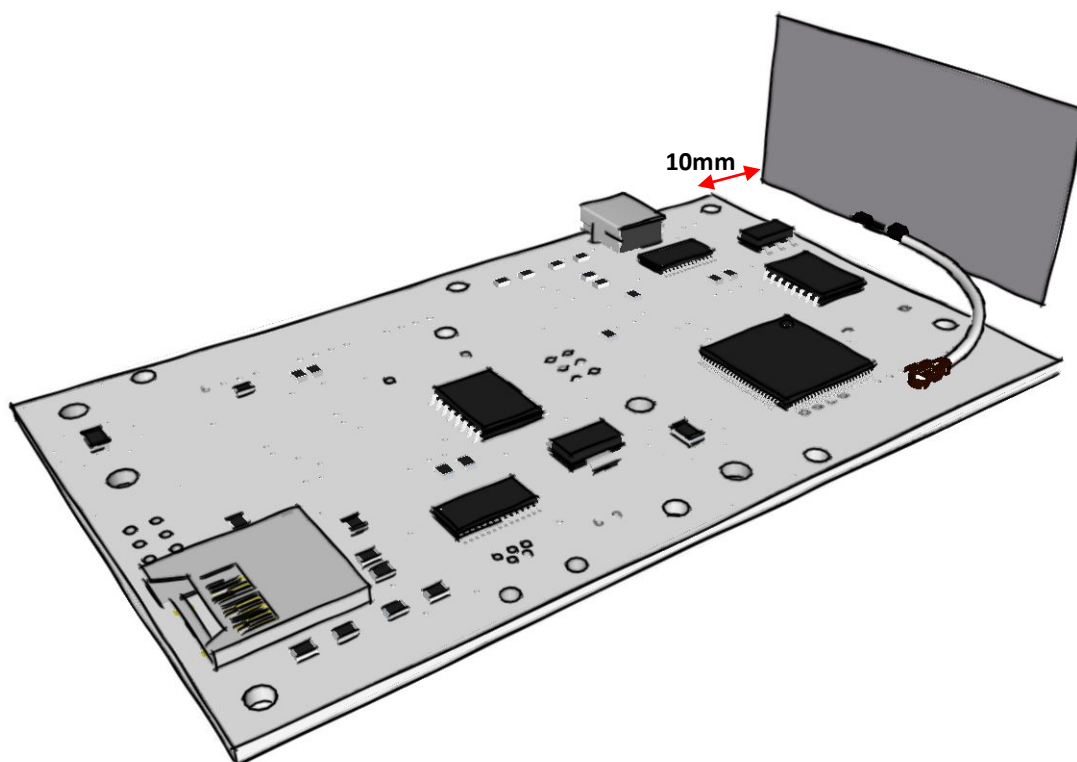
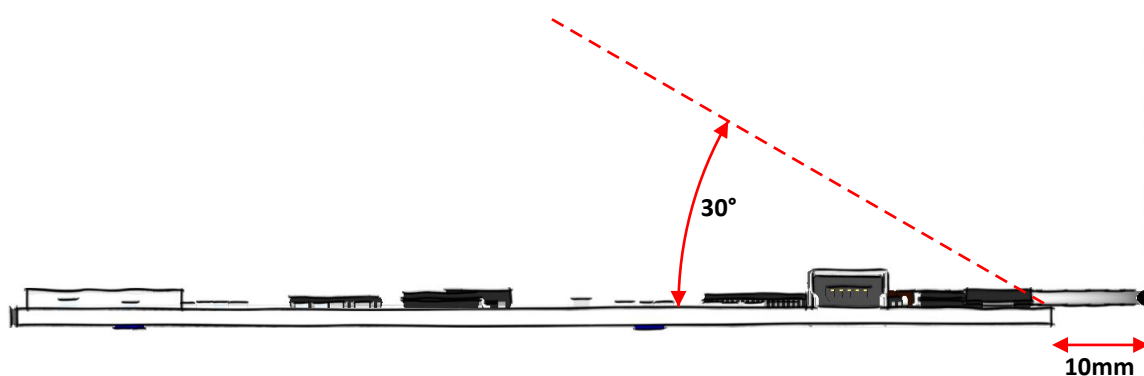

### 3./ MIMO AND ARRAY SYSTEM

When 2 or more antennas are used in an RF System/Solution, we need to follow certain guidelines to avoid auto-cancellation between the antennas, since each antenna is a resonating element radiating and trapping energy around, and when multiple antennas are collocated this can cause interference and auto-cancelling. We need to select the antennas in cross feed, for the Left Corner we need to install the Right-Handed Feed Antenna (2JF0883Pa) and for the Right Corner we need to install the Left-Handed Feed. The optimal distance between the antennas is 40 mm, can be reduced to 30mm and increase with no limit. The same logic applies when 4x4 Array is needed. Please see image below:

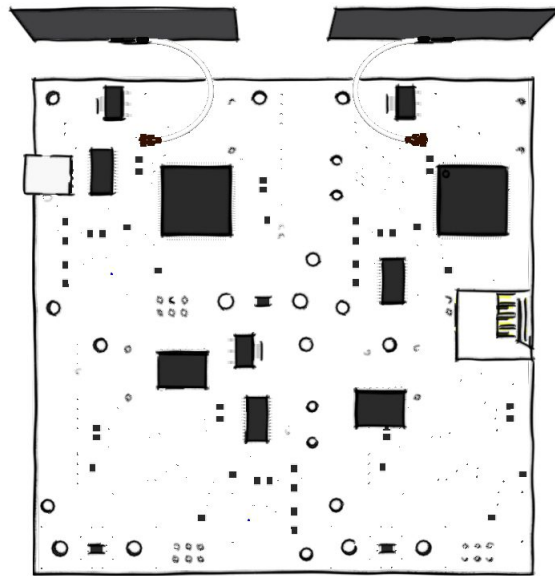

MIMO SYSTEM (Top view)

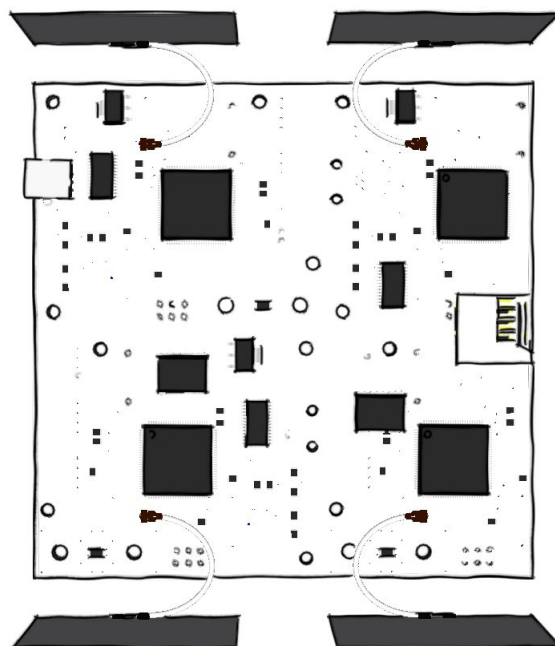

4x4 ARRAY (Top view)

#### 4./ CABLE LENGTH AND ROUTING

Cable plays an important role on the proper functionality of the antenna, the optimal cable length is 42 mm but can be reduced to a minimum of 35mm and a maximum of 50mm, unfortunately this antenna cannot be used with a large RF cable, as the antenna technology embedded into the antenna will not function, and we lose the super high efficiency performance at the small size. The first recommended choice for cable routing is an Inverted L-Shape and second is the Inverted C-Shape; other shapes may be possible on case by case for fine tuning, but the first 2 options should cover the majority of needs. The RF Cable resolution is in 1mm increment for ordering, with +/- 1 mm of tolerance.

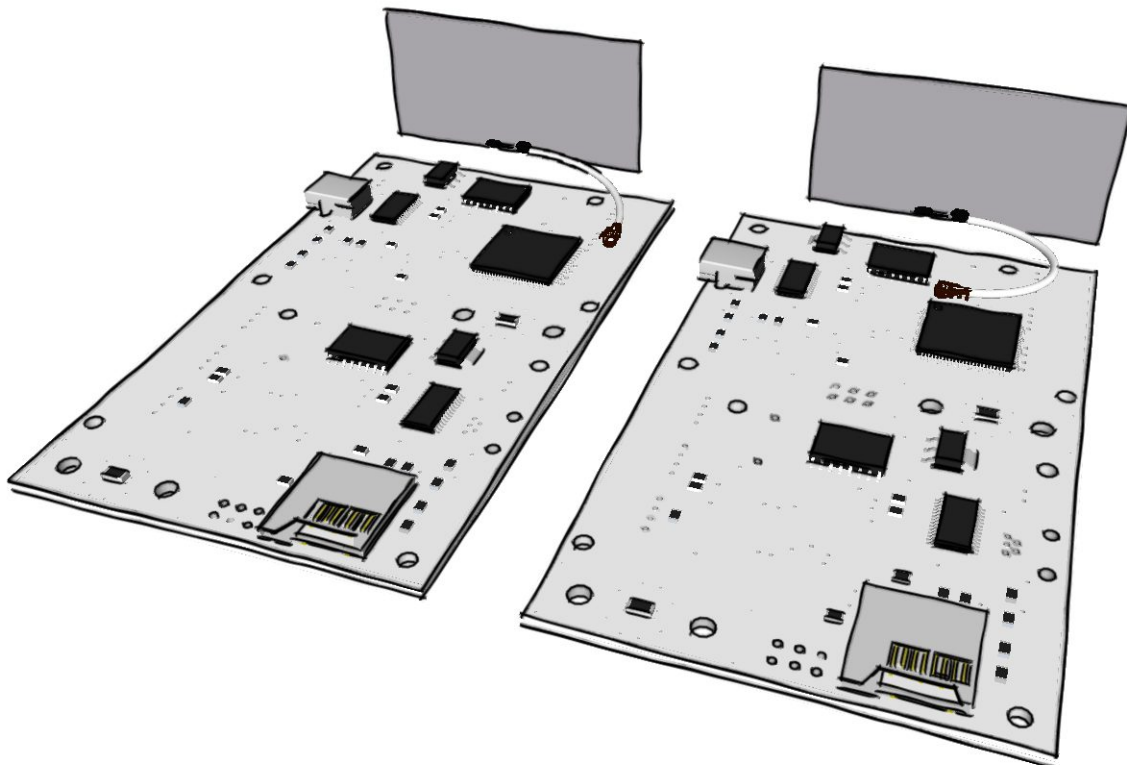

#### 5./ RECOMMENDED MATCHING NETWORK

The starting point is to add a zero ohm resistor on the series component. Most of the cases will not need matching components, but is recommend to add the below network spaces in the case is needed, for a later fine tuning or a filter for spurious emissions if applies. Please use 0402 components size, ideal for RF applications.

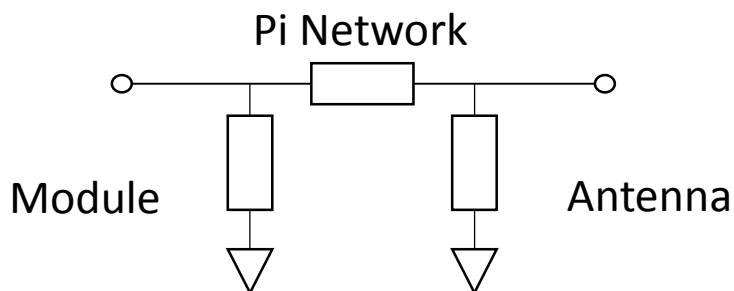

**6./ RECOMMENDED TRANSMISSION LINE**

For RF devices, 4 or more PCB layers is essential and for better noise immunity we highly recommend the use of CPW-G (Co-Planar Waveguide Grounded) type of transmission line, please ensure during calculation, this is not confused with CPW (Not grounded) and keep in mind to have 3 times the width of the signal track the ground plane pours on each side; this to maintain good signal integrity (likewise for the others). In some cases, Microstrip transmission line can be selected but this introduces difficulties for the antenna grounding and for analysis of the integration measurement in the chamber. The third and more specific configuration is the Strip Line. This kind of transmission line is more common on GNSS applications where the TX line must be inside the PCB ground planes to protect the signal from outside and surface noise.

This transmission line is more specific and difficult to integrate since it may require more PCB layers. Typically, this Tx line is found in cell phone design due to is noise quieting. See images below:

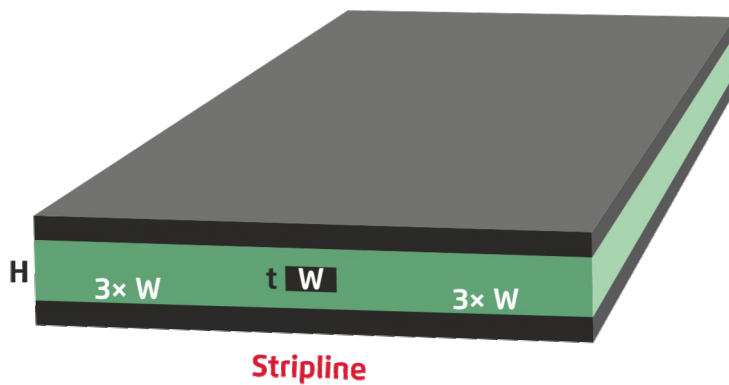
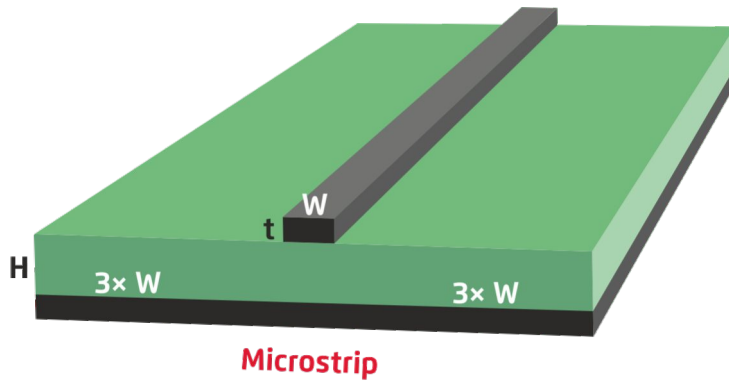
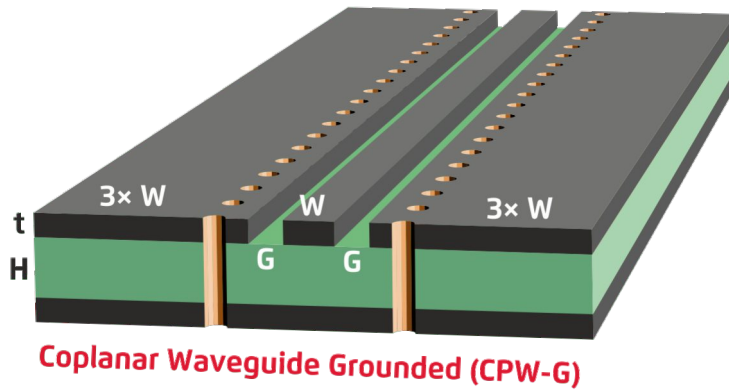

**7./ GROUND PLANE VS EFFICIENCY**

The below test data shows the performance for different ground plane lengths, across the entire 5G NR/4G LTE/3G/2G spectrum from 617-960, 1427-2690, 3300-5000 and 5150-5925 MHz. The antenna parameters presented are efficiency, peak gain, and average gain, and this will help to estimate the minimum ground plane needed to pass specific certifications around the world, we measure from optimal ground plane to the minimum possible (from 120 mm to 50 mm.)

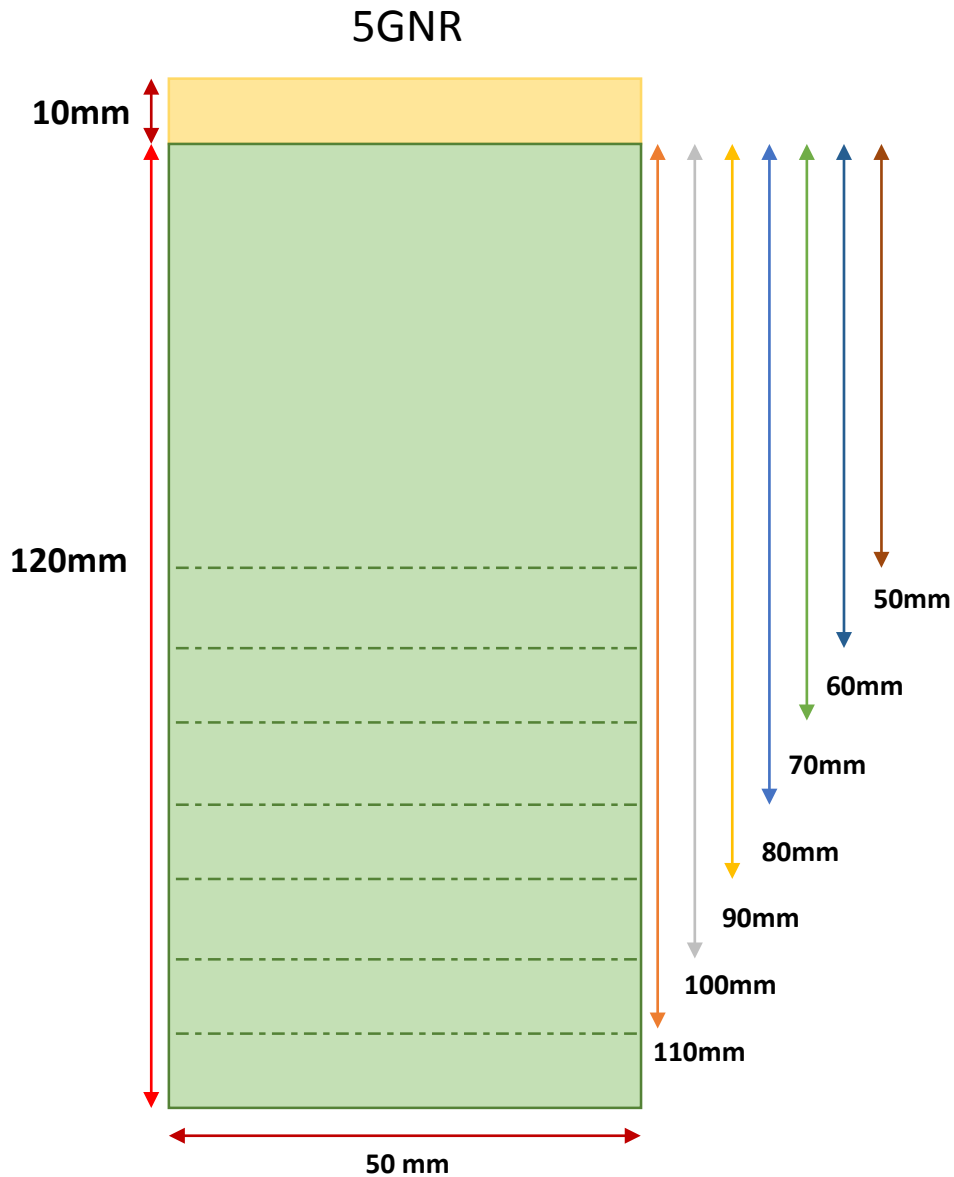

— 2JF0883P-120mm    — 2JF0883P-110mm    — 2JF0883P-100mm    — 2JF0883P-90mm  
— 2JF0883P-80mm    — 2JF0883P-70mm    — 2JF0883P-60mm    — 2JF0883P-50mm

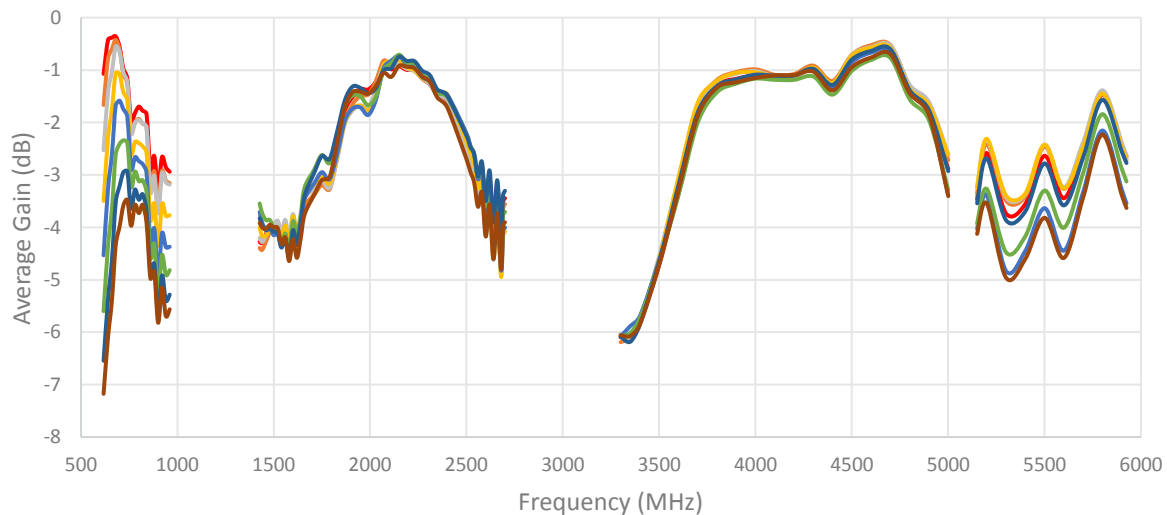
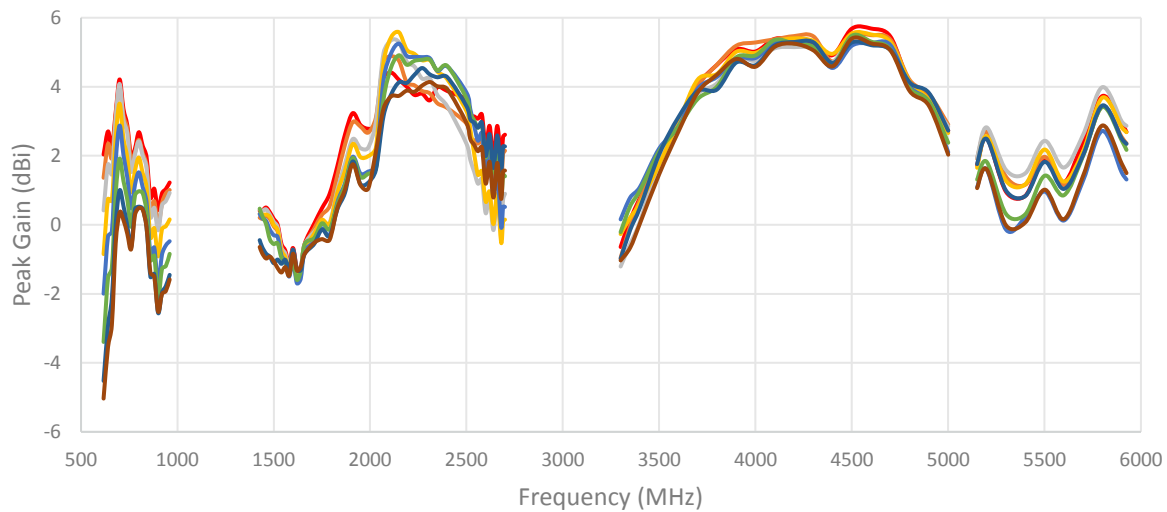
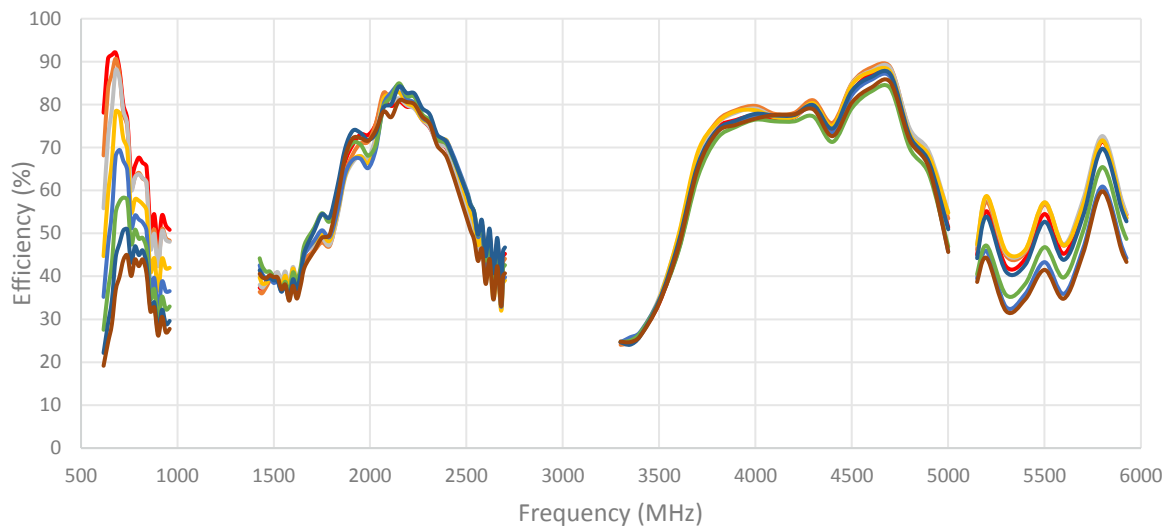



#### 8./ PROHIBITED IMPLEMENTATIONS

- ☒ We cannot utilize this antenna with long RF cable.
- ☒ Cable routing is important, like recommended above.
- ☒ We need to keep minimal distance from PCB ground plane edge.
- ☒ Antenna must be orthogonal to PCB (can be flushed with PCB but still requires distance from PCB ground plane edge).
- ☒ Antenna cannot be mounted above and inside the boundaries of PCB ground plane.
- ☒ Antenna cannot be mounted parallel and inside the boundaries of PCB ground plane.
- ☒ Ground plane edge must be in straight line along the whole PCB edge, where the antenna is mounted, called the prohibited area.
- ☒ On said prohibited area we cannot have ground plane pours, traces, electronic components, etc.
- ☒ Keep clean the entire prohibited area along the whole edge.

## 5. Antenna Images

