

## Data sheet | Item number: 285-181

2-conductor through terminal block; 95 mm<sup>2</sup>; lateral marker slots; with fixing flanges; POWER CAGE CLAMP; 95,00 mm<sup>2</sup>; gray

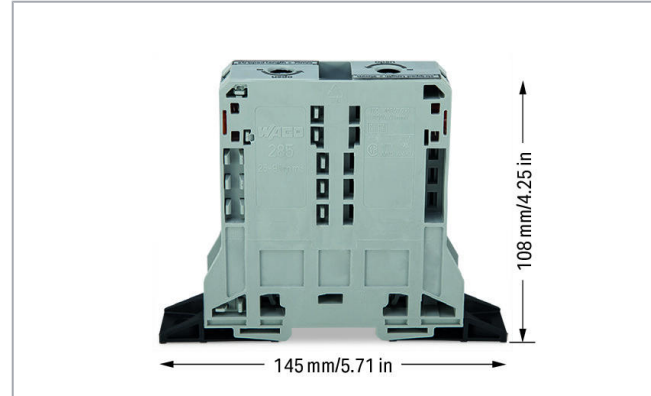

[www.wago.com/285-181](http://www.wago.com/285-181)



### Data

#### Electrical data

Voltage type 1	AC/DC
Voltage type 2	DC

#### Ratings per IEC/EN

Ratings per	IEC/EN 60947-7-1
Nominal voltage (III/3)	1000 V
Rated surge voltage (III/3)	12 kV
Rated current	232 A
Rated voltage (III/3) 2	1500 V
Rated surge voltage (III/3) 2	12 kV
Legend (ratings)	(III / 3) ≙ Overvoltage category III / Pollution degree 3

#### Ratings per UL

Approvals per	UL 1059
Rated voltage UL (Use Group B)	600 V

Subject to changes. Please also observe the further product documentation!

WAGO Kontakttechnik GmbH & Co. KG  
Hansastr. 27  
32423 Minden  
Phone: +49571 887-0 | Fax: +49571 887-169  
Email: [info.de@wago.com](mailto:info.de@wago.com) | Web: [www.wago.com](http://www.wago.com)

Do you have any questions about our products?  
We are always happy to take your call at +49 (571) 887-44222.



Rated current UL (Use Group B)	200 A
Rated voltage UL (Use Group C)	600 V
Rated current UL (Use Group C)	200 A

### Ratings per CSA

Approvals per	C22.2 No 158
Rated voltage CSA (Use Group B)	1000 V
Rated current CSA (Use Group B)	210 A
Rated voltage CSA (Use Group C)	1000 V
Rated current CSA (Use Group D)	210 A

### Connection data

Connection technology	POWER CAGE CLAMP
Actuation type	Operating tool
Connectable conductor materials	Copper
Solid conductor	25 ... 95 mm <sup>2</sup> / 4 ... 4/0 AWG
Stranded conductor	25 ... 95 mm <sup>2</sup> / 4 ... 4/0 AWG
Fine-stranded conductor	25 ... 95 mm <sup>2</sup> / 4 ... 4/0 AWG
Strip length	35 mm / 1.38 inch
Total number of connection points	2
Total number of potentials	1
Number of levels	1
Wiring type	Side-entry wiring

### Physical data

Width	25 mm / 0.984 inch
Height from the surface	108 mm / 4.252 inch
Depth	145 mm / 5.709 inch

### Mechanical data

Design	horizontal type
Mounting type	Mounting flange
Marking level	Side marking

### Material data

Color	gray
-------	------

Subject to changes. Please also observe the further product documentation!



Insulation material	Polyamide (PA66)
Weight	270.4 g

### Commercial data



Packaging type	BOX
Country of origin	PL
GTIN	4055143583930
Customs tariff number	85369010000

### Approvals / Certificates

#### Country specific Approvals

Logo	Approval	Additional Approval Text	Certificate name
	CCA DEKRA Certification B.V.	EN 60947	NTR NL-7707
	CSA DEKRA Certification B.V.	C22.2	1151144
	KEMA/KEUR DEKRA Certification B.V.	EN 60947	71-101911

#### Ship Approvals

Logo	Approval	Additional Approval Text	Certificate name
	ABS American Bureau of Shipping	EN 60947	20-HG1941090-PDA
	DNV GL Det Norske Veritas, Germanischer Lloyd	-	TAE00001V2

#### UL-Approvals

Logo	Approval	Additional Approval Text	Certificate name
	UL	UL 1059	E45172

Subject to changes. Please also observe the further product documentation!

Underwriters Laboratories Inc.



## Compatible products

### potential distribution

	<b>Item no.: 285-407</b> Power tap; for 95 mm <sup>2</sup> high-current tbs; 10,00 mm <sup>2</sup> ; gray	<a href="http://www.wago.com/285-407">www.wago.com/285-407</a>
--	--	--

	<b>Item no.: 855-951/250-000</b> Current and voltage tap up to 95 mm <sup>2</sup> ; Primary rated current: 250 A; Secondary rated current: 1 A; Rated power: 0.2 VA; Accuracy class: 0.5; fused	<a href="http://www.wago.com/855-951/250-000">www.wago.com/855-951/250-000</a>
--	---	--

### ferrule

	<b>Item no.: 216-413</b> Ferrule; Sleeve for 25 mm <sup>2</sup> / AWG 4; uninsulated; electro-tin plated; electrolytic copper; gastight crimped; acc. to DIN 46228, Part 1/08.92; silver-colored	<a href="http://www.wago.com/216-413">www.wago.com/216-413</a>
--	---	--

	<b>Item no.: 216-414</b> Ferrule; Sleeve for 35 mm <sup>2</sup> / AWG 2; uninsulated; electro-tin plated; electrolytic copper; gastight crimped; acc. to DIN 46228, Part 1/08.92; silver-colored	<a href="http://www.wago.com/216-414">www.wago.com/216-414</a>
--	---	--

	<b>Item no.: 216-424</b> Ferrule; Sleeve for 35 mm <sup>2</sup> / AWG 2; uninsulated; electro-tin plated; electrolytic copper; gastight crimped; acc. to DIN 46228, Part 1/08.92; silver-colored	<a href="http://www.wago.com/216-424">www.wago.com/216-424</a>
---	---	--

	<b>Item no.: 216-425</b> Ferrule; Sleeve for 50 mm <sup>2</sup> / AWG 1; uninsulated; electro-tin plated; electrolytic copper; gastight crimped; acc. to DIN 46228, Part 1/08.92	<a href="http://www.wago.com/216-425">www.wago.com/216-425</a>
--	---	--

	<b>Item no.: 216-435</b> Ferrule; Sleeve for 50 mm <sup>2</sup> / AWG 1; uninsulated; electro-tin plated; electrolytic copper; gastight crimped; acc. to DIN 46228, Part 1/08.92	<a href="http://www.wago.com/216-435">www.wago.com/216-435</a>
--	---	--

### Marking accessories















	<b>Item no.: 2009-115</b> WMB-Inline; for Smart Printer; 1500 pieces on roll; stretchable 5 - 5.2 mm; plain; snap-on type; white	<a href="http://www.wago.com/2009-115">www.wago.com/2009-115</a>
--	---	--

	<b>Item no.: 2009-115/000-002</b> WMB-Inline; for Smart Printer; 1500 pieces on roll; stretchable 5 - 5.2 mm; plain; snap-on type; yellow	<a href="http://www.wago.com/2009-115/000-002">www.wago.com/2009-115/000-002</a>
--	--	--

	<b>Item no.: 2009-115/000-005</b> WMB-Inline; for Smart Printer; 1500 pieces on roll; stretchable 5 - 5.2 mm; plain; snap-on type; red	<a href="http://www.wago.com/2009-115/000-005">www.wago.com/2009-115/000-005</a>
--	---	--

	<b>Item no.: 2009-115/000-006</b> WMB-Inline; for Smart Printer; 1500 pieces on roll; stretchable 5 - 5.2 mm; plain; snap-on type; blue	<a href="http://www.wago.com/2009-115/000-006">www.wago.com/2009-115/000-006</a>
--	--	--

Subject to changes. Please also observe the further product documentation!

	<b>Item no.: 2009-115/000-007</b> WMB-Inline; for Smart Printer; 1500 pieces on roll; stretchable 5 - 5.2 mm; plain; snap-on type; gray	<a href="http://www.wago.com/2009-115/000-007">www.wago.com/2009-115/000-007</a>
	<b>Item no.: 2009-115/000-012</b> WMB-Inline; for Smart Printer; 1500 pieces on roll; stretchable 5 - 5.2 mm; plain; snap-on type; orange	<a href="http://www.wago.com/2009-115/000-012">www.wago.com/2009-115/000-012</a>
	<b>Item no.: 2009-115/000-017</b> WMB-Inline; for Smart Printer; 1500 pieces on roll; stretchable 5 - 5.2 mm; plain; snap-on type; light green	<a href="http://www.wago.com/2009-115/000-017">www.wago.com/2009-115/000-017</a>
	<b>Item no.: 2009-115/000-023</b> WMB-Inline; for Smart Printer; 1500 pieces on roll; stretchable 5 - 5.2 mm; plain; snap-on type; green	<a href="http://www.wago.com/2009-115/000-023">www.wago.com/2009-115/000-023</a>
	<b>Item no.: 2009-115/000-024</b> WMB-Inline; for Smart Printer; 1500 pieces on roll; stretchable 5 - 5.2 mm; plain; snap-on type; violet	<a href="http://www.wago.com/2009-115/000-024">www.wago.com/2009-115/000-024</a>
	<b>Item no.: 209-185</b> Adaptor; gray	<a href="http://www.wago.com/209-185">www.wago.com/209-185</a>
	<b>Item no.: 249-105</b> Group marker carrier; gray	<a href="http://www.wago.com/249-105">www.wago.com/249-105</a>
	<b>Item no.: 285-442</b> Adaptor; gray	<a href="http://www.wago.com/285-442">www.wago.com/285-442</a>
	<b>Item no.: 793-501</b> WMB marking card; as card; not stretchable; plain; snap-on type; white	<a href="http://www.wago.com/793-501">www.wago.com/793-501</a>
	<b>Item no.: 793-501/000-002</b> WMB marking card; as card; not stretchable; plain; snap-on type; yellow	<a href="http://www.wago.com/793-501/000-002">www.wago.com/793-501/000-002</a>
	<b>Item no.: 793-501/000-005</b> WMB marking card; as card; not stretchable; plain; snap-on type; red	<a href="http://www.wago.com/793-501/000-005">www.wago.com/793-501/000-005</a>
	<b>Item no.: 793-501/000-006</b> WMB marking card; as card; not stretchable; plain; snap-on type; blue	<a href="http://www.wago.com/793-501/000-006">www.wago.com/793-501/000-006</a>
	<b>Item no.: 793-501/000-007</b> WMB marking card; as card; not stretchable; plain; snap-on type; gray	<a href="http://www.wago.com/793-501/000-007">www.wago.com/793-501/000-007</a>
	<b>Item no.: 793-501/000-012</b> WMB marking card; as card; not stretchable; plain; snap-on type; orange	<a href="http://www.wago.com/793-501/000-012">www.wago.com/793-501/000-012</a>

Subject to changes. Please also observe the further product documentation!



**Item no.: 793-501/000-017**

WMB marking card; as card; not stretchable; plain; snap-on type; light green

[www.wago.com/793-501/000-017](http://www.wago.com/793-501/000-017)



**Item no.: 793-501/000-023**

WMB marking card; as card; not stretchable; plain; snap-on type; green

[www.wago.com/793-501/000-023](http://www.wago.com/793-501/000-023)



**Item no.: 793-501/000-024**

WMB marking card; as card; not stretchable; plain; snap-on type; violet

[www.wago.com/793-501/000-024](http://www.wago.com/793-501/000-024)



**Item no.: 793-5501**

WMB marking card; as card; for terminal block width 5 - 17.5 mm; stretchable 5 - 5.2 mm; plain; snap-on type; white

[www.wago.com/793-5501](http://www.wago.com/793-5501)



**Item no.: 793-5501/000-002**

WMB marking card; as card; for terminal block width 5 - 17.5 mm; stretchable 5 - 5.2 mm; plain; snap-on type; yellow

[www.wago.com/793-5501/000-002](http://www.wago.com/793-5501/000-002)



**Item no.: 793-5501/000-005**

WMB marking card; as card; for terminal block width 5 - 17.5 mm; stretchable 5 - 5.2 mm; plain; snap-on type; red

[www.wago.com/793-5501/000-005](http://www.wago.com/793-5501/000-005)



**Item no.: 793-5501/000-006**

WMB marking card; as card; for terminal block width 5 - 17.5 mm; stretchable 5 - 5.2 mm; plain; snap-on type; blue

[www.wago.com/793-5501/000-006](http://www.wago.com/793-5501/000-006)



**Item no.: 793-5501/000-007**

WMB marking card; as card; for terminal block width 5 - 17.5 mm; stretchable 5 - 5.2 mm; plain; snap-on type; gray

[www.wago.com/793-5501/000-007](http://www.wago.com/793-5501/000-007)



**Item no.: 793-5501/000-012**

WMB marking card; as card; for terminal block width 5 - 17.5 mm; stretchable 5 - 5.2 mm; plain; snap-on type; orange

[www.wago.com/793-5501/000-012](http://www.wago.com/793-5501/000-012)



**Item no.: 793-5501/000-014**

WMB marking card; as card; for terminal block width 5 - 17.5 mm; stretchable 5 - 5.2 mm; plain; snap-on type; brown

[www.wago.com/793-5501/000-014](http://www.wago.com/793-5501/000-014)



**Item no.: 793-5501/000-017**

WMB marking card; as card; for terminal block width 5 - 17.5 mm; stretchable 5 - 5.2 mm; plain; snap-on type; green

[www.wago.com/793-5501/000-017](http://www.wago.com/793-5501/000-017)



**Item no.: 793-5501/000-023**

WMB marking card; as card; for terminal block width 5 - 17.5 mm; stretchable 5 - 5.2 mm; plain; snap-on type; light green

[www.wago.com/793-5501/000-023](http://www.wago.com/793-5501/000-023)



**Item no.: 793-5501/000-024**

WMB marking card; as card; for terminal block width 5 - 17.5 mm; stretchable 5 - 5.2 mm; plain; snap-on type; violet

[www.wago.com/793-5501/000-024](http://www.wago.com/793-5501/000-024)

#### Protective Warning Marker

Subject to changes. Please also observe the further product documentation!

WAGO Kontakttechnik GmbH & Co. KG  
Hansastr. 27  
32423 Minden  
Phone: +49571 887-0 | Fax: +49571 887-169  
Email: [info.de@wago.com](mailto:info.de@wago.com) | Web: [www.wago.com](http://www.wago.com)

Do you have any questions about our products?  
We are always happy to take your call at +49 (571) 887-44222.



**Item no.: 285-170**  
Protective warning marker; with high-voltage symbol, black; yellow

[www.wago.com/285-170](http://www.wago.com/285-170)



**Item no.: 285-175**  
Protective warning marker; yellow

[www.wago.com/285-175](http://www.wago.com/285-175)

**Jumper**



**Item no.: 285-495**  
Jumper; insulated; gray

[www.wago.com/285-495](http://www.wago.com/285-495)

**assembling**



**Item no.: 285-168**  
Fixing element; for 95 mm<sup>2</sup> high-current terminal blocks; orange

[www.wago.com/285-168](http://www.wago.com/285-168)

**protection**



**Item no.: 285-169**  
Finger guard; touchproof cover protects unused conductor entries and jumper slots; for 95 mm<sup>2</sup> high-current tbs; yellow

[www.wago.com/285-169](http://www.wago.com/285-169)

**tools**



**Item no.: 285-172**  
Allen wrench; with a partially insulated shaft; green

[www.wago.com/285-172](http://www.wago.com/285-172)



**Item no.: 285-173**  
Allen wrench; with a partially insulated shaft; with anti-rotation protection; green

[www.wago.com/285-173](http://www.wago.com/285-173)

**Downloads**

**Documentation**

**Bid Text**

285-181 X81 - Datei	19. 2. 2019	xml 3.3 kB	Download
------------------------	-------------	---------------	----------

285-181 doc - Datei	4. 1. 2018	doc 24.1 kB	Download
------------------------	------------	----------------	----------

**Additional Information**

Technical explanations	3. 4. 2019	pdf 2.2 MB	Download
------------------------	------------	---------------	----------

**CAD/CAE-Data**

**CAD data**

2D/3D Models 285-181		URL	Download
----------------------	--	-----	----------

**CAE data**

Subject to changes. Please also observe the further product documentation!

ZUKEN Portal 285-181

[URL](#)

[Download](#)

EPLAN Data Portal 285-181

[URL](#)

[Download](#)

## Environmental Product Compliance

### Compliance Search

Environmental Product Compliance 285-181

[URL](#)

[Download](#)

2-conductor through terminal block; 95 mm<sup>2</sup>; lateral marker slots; with fixing flanges;

POWER CAGE CLAMP; 95,00 mm<sup>2</sup>; gray

## Installation Notes

### Installation

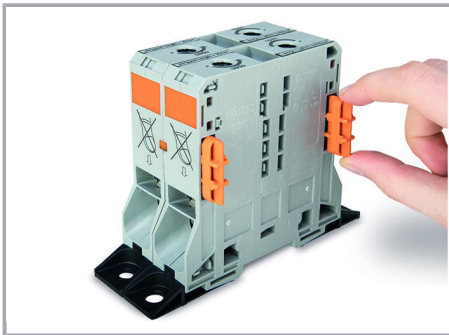

Optionally, insert block-to-block connector (285-168) into housing slot.

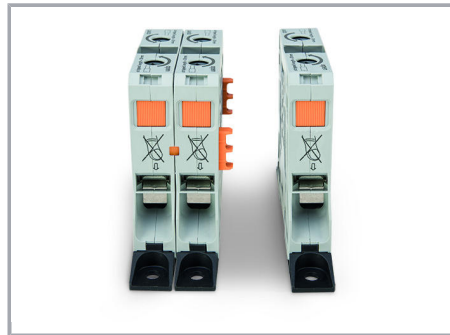

Align and snap high-current, through terminal blocks together.

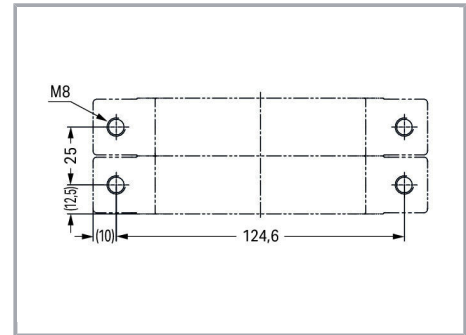

## Product family

### POWER CAGE CLAMP

[Show all products from the family](#)

Subject to changes. Please also observe the further product documentation!

WAGO Kontakttechnik GmbH & Co. KG

Hansastr. 27

32423 Minden

Phone: +49571 887-0 | Fax: +49571 887-169

Email: [info.de@wago.com](mailto:info.de@wago.com) | Web: [www.wago.com](http://www.wago.com)

Do you have any questions about our products?

We are always happy to take your call at +49 (571) 887-44222.