

Display Elektronik GmbH

**DATA SHEET**

***OLED-MODULE***

**DEP 128128A1-W  
ROUND - 1,18" - OLED**

**Product Specification**

**Ver.: 6**

**18.11.2020**

## **Revision History**

| <b>VERSION</b> | <b>DATE</b> | <b>REVISED PAGE NO.</b> | <b>Note</b>                                    |
|----------------|-------------|-------------------------|--|
| 0              | 29.11.2019  |                         | First release                                  |
| 1              | 18.12.2019  |                         | Modify Precautions                             |
| 2              | 28.04.2020  |                         | Modify General<br>Specification                |
| 3              | 29.05.2020  |                         | Modify Module<br>Classification<br>Information |
| 4              | 26.08.2020  |                         | Modify Inspection<br>specification             |
| 5              | 16.10.2020  |                         | Modify Contrast Ratio                          |
| 6              | 18.11.2020  |                         | Modify Storage<br>Precautions                  |

# **Contents**

1. General Specification
2. Interface Pin Function
3. Contour Drawing & Block Diagram
4. Absolute Maximum Ratings
5. Electrical Characteristics
6. Optical Characteristics
7. OLED Lifetime
8. Reliability
9. Inspection specification
10. Precautions in use of OLED Modules

# **1. General Specification**

The Features is described as follow:

- Module dimension:            Ø50.50 x 5.00 mm
- Active area:                 Ø30.00 mm
- Dot Matrix:                 128 x 128
- Pixel size:                 0.210 x 0.210 mm
- Pixel pitch:                0.235 × 0.235 mm
- Display Mode:             Passive Matrix
- Duty:                        1/128 Duty
- Gray Scale:                4 Bits
- Display Color:             White
- IC:                         SSD1327
- Interface:                 4-line SPI , I2C
- SIZE:                      1.18 Inch
- CTP IC:                    IT7259
- Detect Point:             1
- CTP Interface:            I2C
- CTP Surface Hardness:    6H

## 2.Interface Pin Function

| No. | Symbol     | Function  |     |           |   |            |   |     |
|-----|------------|---|-----|-----------|---|------------|---|-----|
| 1   | VSS        | Ground pin. It must be connected to external ground.  |     |           |   |            |   |     |
| 2   | VCC        | Power supply for panel driving voltage. This is also the most positive power voltage supply pin. It is supplied by external high voltage source.  |     |           |   |            |   |     |
| 3   | VCOMH      | COM signal deselected voltage level.<br>A capacitor should be connected between this pin and VSS. No external power supply is allowed to connect to this pin.   |     |           |   |            |   |     |
| 4   | VCI        | Low voltage power supply and power supply for interface logic level. It should match with the MCU interface voltage level and must be connected to external source.<br>VCI must always set to be equivalent to or higher than VDD.  |     |           |   |            |   |     |
| 5   | VDD        | Power supply pin for core logic operation.  |     |           |   |            |   |     |
| 6   | BS1        | MCU bus interface selection pins. Select appropriate logic setting as described in the following table. BS1 is pin select.<br>Bus Interface selection<br><table border="1" style="margin-left: 20px;"> <thead> <tr> <th>BS1</th> <th>Interface</th> </tr> </thead> <tbody> <tr> <td>0</td> <td>4-line SPI</td> </tr> <tr> <td>1</td> <td>I2C</td> </tr> </tbody> </table><br>Note (1) 0 is connected to VSS (2) 1 is connected to VCI | BS1 | Interface | 0 | 4-line SPI | 1 | I2C |
| BS1 | Interface  |   |     |           |   |            |   |     |
| 0   | 4-line SPI |   |     |           |   |            |   |     |
| 1   | I2C        |   |     |           |   |            |   |     |
| 7   | IREF       | This pin is the segment output current reference pin  |     |           |   |            |   |     |
| 8   | CS#        | This pin is the chip select input connecting to the MCU.<br>The chip is enabled for MCU communication only when CS# is pulled LOW (active LOW).   |     |           |   |            |   |     |
| 9   | RES#       | This pin is reset signal input.<br>When the pin is pulled LOW, initialization of the chip is executed.<br>Keep this pin pull HIGH during normal operation.  |     |           |   |            |   |     |
| 10  | DC#        | This pin is Data/Command control pin connecting to the MCU.<br>When the pin is pulled HIGH, will be interpreted as data.<br>When the pin is pulled LOW, will be transferred to a command register<br>In I2C mode, this pin acts as SA0 for slave address selection.   |     |           |   |            |   |     |
| 11  | D0         | When serial interface mode is selected, D0 will be the serial clock input:  |     |           |   |            |   |     |
| 12  | D1         | SCLK; D1 will be the serial data input: SDIN and D2 should be kept NC.  |     |           |   |            |   |     |
| 13  | D2         | When I2C mode is selected, D2, D1 should be tied together and serve as SDAout, SDAin in application and D0 is the serial clock input, SCL.  |     |           |   |            |   |     |

|    |        |  |
|----|--------|--|
| 14 | TP_SCK | I2C clock signal   |
| 15 | TP_SDA | I2C data signal  |
| 16 | TP_INT | Interrupt signal   |
| 17 | VCC    | Power supply for panel driving voltage. This is also the most positive power voltage supply pin. |
| 18 | VSS    | Ground   |



### 3.1 Application recommendations

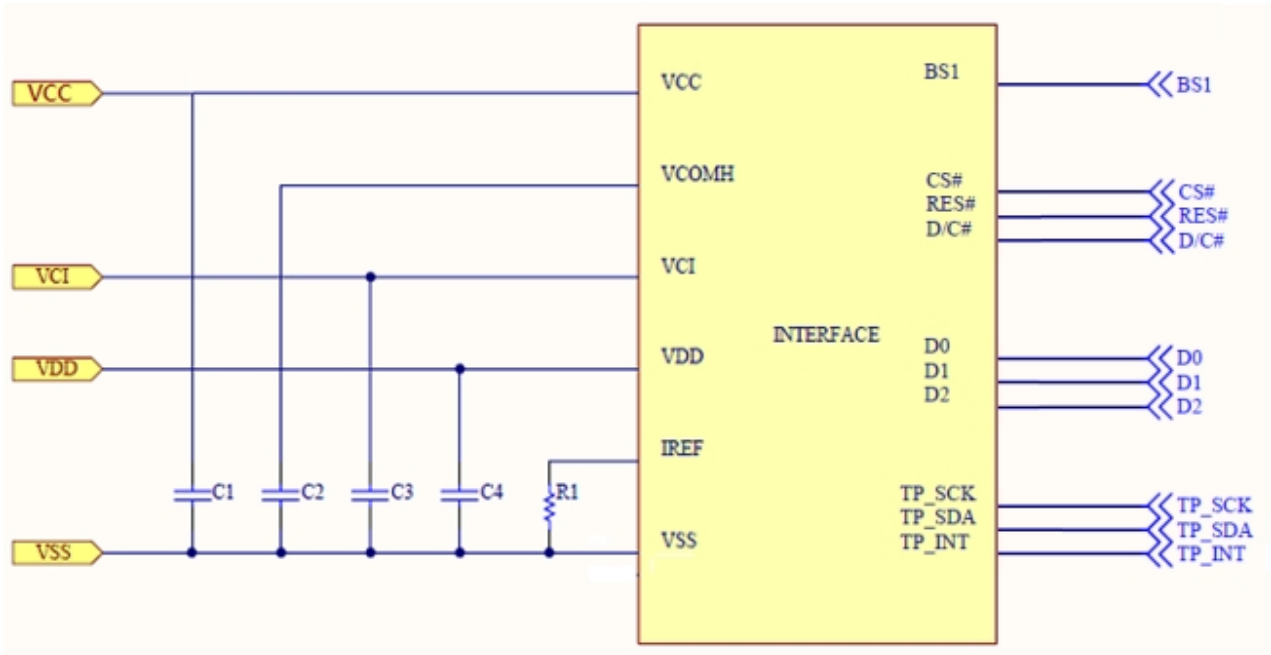

Recommended components:

C1, C2 : 4.7uF/25V/0805

C3, C4 : 1.0uF/16V/0603

Bus Interface selection: (Must be set the BS1, refer to item 3)

4-line SPI , I2C

Voltage at IREF  $\approx$  VCC – 3V. For VCC = 14.5V, IREF = 10uA:

$R1 = (\text{Voltage at IREF} - VSS) / IREF$

$\approx (14.5 - 3)V / 10\mu A = 1.15M\Omega$



## **4. Absolute Maximum Ratings**

| Parameter                    | Symbol | Min  | Max  | Unit | Notes |
|------------------------------|--------|------|------|------|-------|
| Supply Voltage for Operation | VCI    | -0.3 | 4.0  | V    | 1, 2  |
| Supply Voltage for Logic     | VDD    | -0.5 | 2.75 | V    | 1, 2  |
| Supply Voltage for Display   | VCC    | -0.5 | 19.0 | V    | 1, 2  |
| Operating Temperature        | TOP    | -20  | +50  | °C   | -     |
| Storage Temperature          | TSTG   | -30  | +70  | °C   | -     |

Note 1: All the above voltages are on the basis of “VSS = 0V”.

Note 2: When this module is used beyond the above absolute maximum ratings, permanent breakage of the module may occur. Also, for normal operations, it is desirable to use this module under the conditions according to Section6 “Electrical Characteristics”. If this module is used beyond these conditions, malfunctioning of the module can occur and the reliability of the module may deteriorate.

## 5. Electrical Characteristics

### 5.1 DC Electrical Characteristics

| Item                              | Symbol | Condition    | Min     | Typ  | Max     | Unit |
|-----------------------------------|--------|--------------|---------|------|---------|------|
| Supply Voltage for Logic          | VCI    | -            | 2.8     | 3.0  | 3.3     | V    |
| Supply Voltage for Display        | VCC    | -            | 14.0    | 14.5 | 15.0    | V    |
| High Level Input                  | VIH    | -            | 0.8×VCI | -    | VCI     | V    |
| Low Level Input                   | VIL    | -            | 0       | -    | 0.2×VCI | V    |
| High Level Output                 | VOH    | Iout = 100uA | 0.9×VCI | -    | VCI     | V    |
| Low Level Output                  | VOL    | Iout = 100uA | 0       | -    | 0.1×VCI | V    |
| 50% Check Board operating Current |        | VCC = 14.5V  | -       | 24   | 36      | mA   |

### 5.2 Touch Panel Controller IT7259

| Item              | Symbol | Condition             | Min | Typ | Max | Unit |
|-------------------|--------|-----------------------|-----|-----|-----|------|
| Input High Volt.  | VIH    | COMS                  | 1.2 | -   | -   | V    |
| Input Low Volt.   | VIL    | COMS                  | -   | -   | 0.5 | V    |
| Output High Volt. | VOH    | I <sub>OH</sub> = 2mA | 2.4 | -   | -   | V    |
| Output Low Volt.  | VOL    | I <sub>OL</sub> = 2mA | -   | -   | 0.4 | V    |

**5.3 Initial code**

```
void Initial_SSD1327(){  
  
    write_command (0xAE); //Set Display Off  
  
    write_command(0x15); //Set Column Address  
    write_command(0x00); //Start Column Address  
    write_command(0x3F); //End Column Address  
  
    write_command(0x75); //Set Row Address (segment)  
    write_command(0x00); //Start Row Address  
    write_command(0x7F); //End Row Address  
  
    write_command(0x81); //Set Contrast Control  
    write_command(0x9b); //Contrast Level  
  
    write_command(0xA0); //Set Re-map  
    write_command(0x51); //Default Setting  
  
    write_command(0xA1); //Set Display Start Line  
    write_command(0x00);  
  
    write_command(0xA2); //Set Display Offset  
    write_command(0x00);  
  
    write_command(0xA4); //Set Display Mode  
  
    write_command(0xA8); //Set Multiplex Ratio  
    write_command(0x7F); //Multiplex  
  
    write_command(0xAB); //Set Function Selection A  
    write_command(0x01);  
  
    write_command(0xB1); //Set Phase Length  
    write_command(0xf1);  
  
    write_command(0xB3); //Set Display Clock Divide Ratio/Oscillator Frequency  
    write_command(0x00);  
  
    write_command(0xBC); //Set Pre-charge Voltage  
    write_command(0x07);  
  
    write_command(0xBE); //Set VCOMH Voltage  
    write_command(0x07);  
  
    write_command(0xB6); //Set Second Pre-charge period  
    write_command(0x0F);  
}
```

```
write_command(0xD5); //Set Function selection B
write_command(0x62);

write_command (0xB8); //Set Gray Scale Table
write_command (4); //01[5:0]
write_command (8); //02[5:0]
write_command (12); //03[5:0]
write_command (16); //04[5:0]
write_command (20); //05[5:0]
write_command (24); //06[5:0]
write_command (28); //07[5:0]
write_command (32); //08[5:0]
write_command (36); //09[5:0]
write_command (40); //10[5:0]
write_command (44); //11[5:0]
write_command (48); //12[5:0]
write_command (52); //13[5:0]
write_command (56); //14[5:0]
write_command (63); //15[5:0]

write_command(0xAF); //Set Display On
}
```

### 5.3.1 Touch panel controller IT7259

#### Device Address

|             |
|-------------|
| I2C Address |
| 1000 110    |

#### Data Transfer Format

Below diagram shows the data transfer format in I<sup>2</sup>C bus of IT7259.

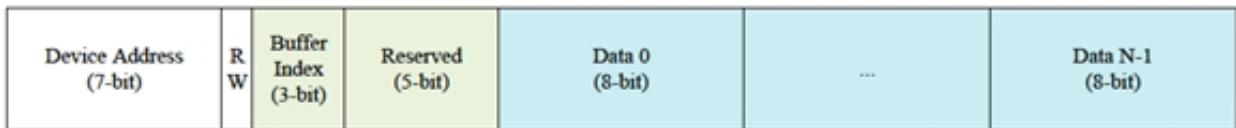

- Device Address (7-bit)  
Specify the address of device that the host wants to communicate. Every device should have a unique device address in the I<sup>2</sup>C bus.
- RW (1-bit)  
Specify the data transfer direction.
- Buffer Index (3-bit)

|      |                          |
|------|--------------------------|
| 111b | Point Information Buffer |
|------|--------------------------|

Note: X-Y Resolutions:150 x 150

#### Tap

GID: 0x20

■ Report Data Format

| Byte | Bit 7                         | Bit 6 | Bit 5 | Bit 4 | Bit 3    | Bit 2 | Bit 1 | Bit 0 |
|------|-------------------------------|-------|-------|-------|----------|-------|-------|-------|
| 0    | Format Tag (1000b)            |       |       |       | Reserved |       |       |       |
| 1    | Gesture Identification (0x20) |       |       |       |          |       |       |       |
| 2    | X Position of Point           |       |       |       |          |       |       |       |
| 3    |                               |       |       |       |          |       |       |       |
| 4    | Y Position of Point           |       |       |       |          |       |       |       |
| 5    |                               |       |       |       |          |       |       |       |
| 6    | Reserved                      |       |       |       |          |       |       |       |
| ...  |                               |       |       |       |          |       |       |       |
| 13   |                               |       |       |       |          |       |       |       |

**Double-Tap**

GID: 0x23

| Byte | Bit 7                         | Bit 6 | Bit 5 | Bit 4 | Bit 3    | Bit 2 | Bit 1 | Bit 0 |
|------|-------------------------------|-------|-------|-------|----------|-------|-------|-------|
| 0    | Format Tag (1000b)            |       |       |       | Reserved |       |       |       |
| 1    | Gesture Identification (0x23) |       |       |       |          |       |       |       |
| 2    | X Position of Point           |       |       |       |          |       |       |       |
| 3    |                               |       |       |       |          |       |       |       |
| 4    | Y Position of Point           |       |       |       |          |       |       |       |
| 5    |                               |       |       |       |          |       |       |       |
| 6    | Reserved                      |       |       |       |          |       |       |       |
| ...  |                               |       |       |       |          |       |       |       |
| 13   |                               |       |       |       |          |       |       |       |

Single Write

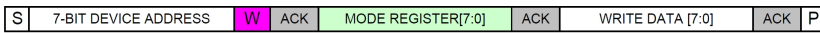

Burst Write

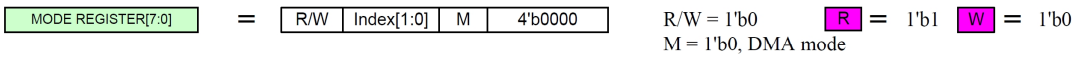
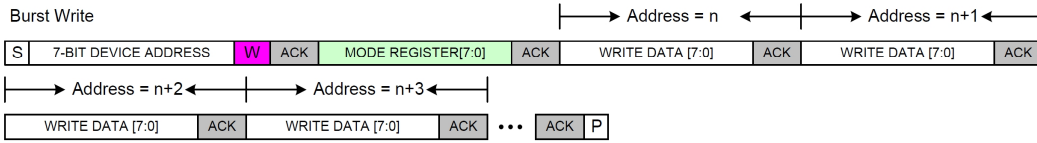

Single Read with SR

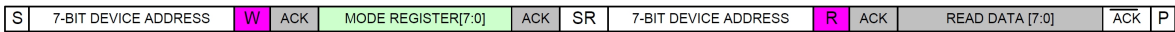

Burst Read with SR

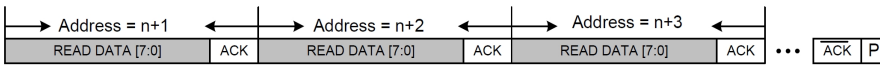
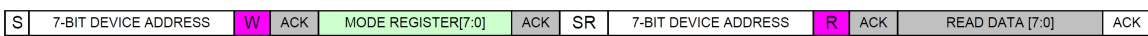

Single Read with STOP

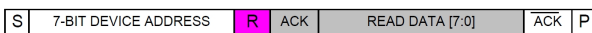

Burst Read with STOP

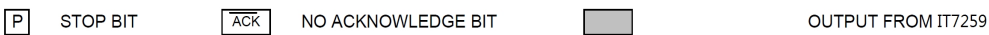
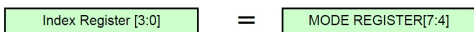
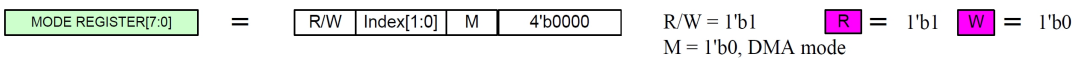
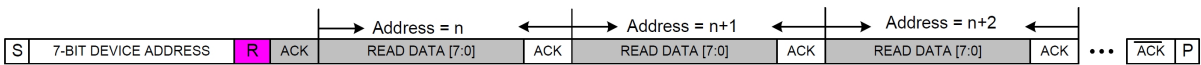

## 6. Optical Characteristics

| Item                                    | Symbol       | Condition | Min      | Typ  | Max  | Unit              |
|---|--------------|-----------|----------|------|------|-------------------|
| View Angle                              | (V) $\theta$ | -         | 160      | -    | -    | deg               |
|   | (H) $\phi$   | -         | 160      | -    | -    | deg               |
| Contrast Ratio                          | CR           | Dark      | 10,000:1 | -    | -    | -                 |
| Response Time                           | T rise       | -         | -        | 10   | -    | $\mu$ s           |
|   | T fall       | -         | -        | 10   | -    | $\mu$ s           |
| Display with 50% check Board Brightness |              |           | 60       | 80   | -    | cd/m <sup>2</sup> |
| CIEx(White)                             |              | (CIE1931) | 0.24     | 0.28 | 0.32 | -                 |
| CIEy(White)                             |              | (CIE1931) | 0.28     | 0.32 | 0.36 | -                 |

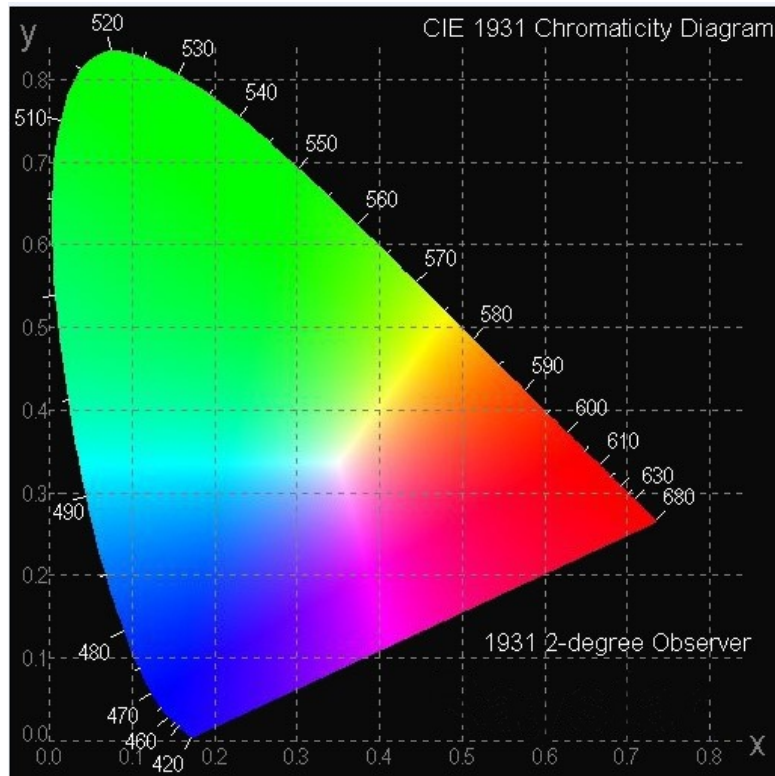



## 7. OLED Lifetime

| ITEM                | Conditions   | Min        | Typ | Remark |
|---------------------|--|------------|-----|--------|
| Operating Life Time | Ta=25°C<br>/ Initial 50% check board<br>brightness Typical Value | 20,000 Hrs | -   | Note   |

Notes:

1. Life time is defined the amount of time when the luminance has decayed to <50% of the initial value.
2. This analysis method uses life data obtained under accelerated conditions to extrapolate an estimated probability density function (*pdf*) for the product under normal use conditions.
3. Screen saving mode will extend OLED lifetime.

## 8. Reliability

### Content of Reliability Test

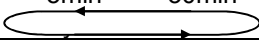
| Environmental Test                   |   |   |                     |
|--------------------------------------|---|---|---------------------|
| Test Item                            | Content of Test   | Test Condition  | Applicable Standard |
| High Temperature storage             | Endurance test applying the high storage temperature for a long time.   | 70°C<br>240hrs  | —                   |
| Low Temperature storage              | Endurance test applying the low storage temperature for a long time.  | -30°C<br>240hrs   | —                   |
| High Temperature Operation           | Endurance test applying the electric stress (Voltage & Current) and the thermal stress to the element for a long time.  | 50°C<br>240hrs  | —                   |
| Low Temperature Operation            | Endurance test applying the electric stress under low temperature for a long time.  | -20°C<br>240hrs   | —                   |
| High Temperature/ Humidity Storage   | Endurance test applying the high temperature and high humidity storage for a long time.   | 60°C,90%RH<br>240hrs  | —                   |
| High Temperature/ Humidity Operation | Endurance test applying the high temperature and high humidity Operation for a long time.   | 60°C,90%RH<br>120hrs  | —                   |
| Temperature Cycle                    | Endurance test applying the low and high temperature cycle.<br>-30°C    25°C    70°C<br><br>30min    5min    30min<br> | -30°C /70°C<br>30 cycles  | —                   |
| Mechanical Test                      |   |   |                     |
| Vibration test                       | Endurance test applying the vibration during transportation and using.  | Frequency:10~55Hz<br>amplitude:1.5mm<br>Time:0.5hrs/axis<br>Test axis:X,Y,Z | —                   |
| Others                               |   |   |                     |
| Static electricity test              | Endurance test applying the electric stress to the finished product housing.  | Air Discharge model<br>±4kv,10 times  | —                   |

\*\*\* Supply voltage for OLED system =Operating voltage at 25°C

**Test and measurement conditions**

1. All measurements shall not be started until the specimens attain to temperature stability.  
After the completion of the described reliability test, the samples were left at room temperature for 2 hrs prior to conducting the failure test at  $23\pm 5^{\circ}\text{C}$ ;  $55\pm 15\%$  RH.
2. All-pixels on/off exchange is used as operation test pattern.
3. The degradation of Polarizer are ignored for High Temperature storage, High Temperature/ Humidity Storage, Temperature Cycle

**Evaluation criteria**

1. The function test is OK.
2. No observable defects.
3. Luminance:  $> 50\%$  of initial value.
4. Current consumption: within  $\pm 50\%$  of initial value.

**APPENDIX:**

**RESIDUE IMAGE**

Because the pixels are lighted in different time, the luminance of active pixels may reduce or differ from inactive pixels. Therefore, the residue image will occur. To avoid the residue image, every pixel needs to be lighted up uniformly.

## 9. Inspection specification

### Inspection Standard:

MIL-STD-105E table normal inspection single sample level II.

### Definition

1 Major defect : The defect that greatly affect the usability of product.

2 Minor defect : The other defects, such as cosmetic defects, etc.

Definition of inspection zone:

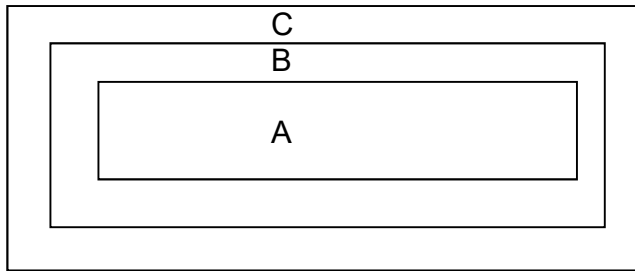

Zone A: Active Area

Zone B: Viewing Area except Zone A

Zone C: Outside Viewing Area



Note: As a general rule, visual defects in Zone C are permissible, when it is no trouble of quality and assembly to customer`s product.

### Inspection Methods

1 The general inspection : Under fluorescent light illumination: 750~1500 Lux, about 30cm viewing distance, within 45° viewing angle, under 25±5°C.

2 The luminance and color coordinate inspection : By SR-3 or BM-7 or the equal equipments, in the dark room, under 25±5°C.

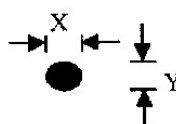
| NO | Item  | Criterion   | AQL  |
|----|---|---|------|
| 01 | Electrical Testing                          | 1.1 Missing vertical, horizontal segment, segment contrast defect.<br>1.2 Missing character , dot or icon.<br>1.3 Display malfunction.<br>1.4 No function or no display.<br>1.5 Current consumption exceeds product specifications.<br>1.6 OLED viewing angle defect.<br>1.7 Mixed product types.<br>1.8 Contrast defect. | 0.65 |
| 02 | Black or White Spots on OLED (Display only) | 2.1 White and black spots on display □0.25mm, no more than three white or black spots present.<br>2.2 Densely spaced: No more than two spots or lines within 3mm.   | 2.5  |

| NO  | Item   | Criterion  | AQL            |                |      |                  |        |      |                         |                      |      |                         |              |                      |               |     |            |               |   |     |     |
|---|--|--|----------------|----------------|------|------------------|--------|------|-------------------------|----------------------|------|-------------------------|--------------|----------------------|---------------|-----|------------|---------------|---|-----|-----|
| 03  | OLED Black Spots, White Spots, Contamination (non-Display) | 3.1 Round type :<br>As following drawing<br>$\Phi = (x + y) / 2$  <table border="1" data-bbox="699 409 1350 703"> <thead> <tr> <th>SIZE</th> <th>Acceptable QTY</th> <th>Zone</th> </tr> </thead> <tbody> <tr> <td><math>\Phi \leq 0.10</math></td> <td>ignore</td> <td>A+ B</td> </tr> <tr> <td><math>0.10 &lt; \Phi \leq 0.20</math></td> <td>2</td> <td>A+ B</td> </tr> <tr> <td><math>0.20 &lt; \Phi \leq 0.25</math></td> <td>1</td> <td>A+ B</td> </tr> <tr> <td><math>0.25 &lt; \Phi</math></td> <td>0</td> <td>A+ B</td> </tr> </tbody> </table>  | SIZE           | Acceptable QTY | Zone | $\Phi \leq 0.10$ | ignore | A+ B | $0.10 < \Phi \leq 0.20$ | 2                    | A+ B | $0.20 < \Phi \leq 0.25$ | 1            | A+ B                 | $0.25 < \Phi$ | 0   | A+ B       | 2.5           |   |     |     |
|   |  | SIZE   | Acceptable QTY | Zone           |      |                  |        |      |                         |                      |      |                         |              |                      |               |     |            |               |   |     |     |
| $\Phi \leq 0.10$  | ignore   | A+ B   |                |                |      |                  |        |      |                         |                      |      |                         |              |                      |               |     |            |               |   |     |     |
| $0.10 < \Phi \leq 0.20$   | 2  | A+ B   |                |                |      |                  |        |      |                         |                      |      |                         |              |                      |               |     |            |               |   |     |     |
| $0.20 < \Phi \leq 0.25$   | 1  | A+ B   |                |                |      |                  |        |      |                         |                      |      |                         |              |                      |               |     |            |               |   |     |     |
| $0.25 < \Phi$   | 0  | A+ B   |                |                |      |                  |        |      |                         |                      |      |                         |              |                      |               |     |            |               |   |     |     |
| 3.2 Line type : (As following drawing)  <table border="1" data-bbox="571 985 1350 1279"> <thead> <tr> <th>Length</th> <th>Width</th> <th>Acceptable QTY</th> <th>Zone</th> </tr> </thead> <tbody> <tr> <td>---</td> <td><math>W \leq 0.02</math></td> <td>ignore</td> <td>A+B</td> </tr> <tr> <td><math>L \leq 3.0</math></td> <td><math>0.02 &lt; W \leq 0.03</math></td> <td rowspan="2">2</td> <td>A+B</td> </tr> <tr> <td><math>L \leq 2.5</math></td> <td><math>0.03 &lt; W \leq 0.05</math></td> <td>A+B</td> </tr> <tr> <td>---</td> <td><math>0.05 &lt; W</math></td> <td>As round type</td> <td></td> </tr> </tbody> </table> | Length   | Width  | Acceptable QTY | Zone           | ---  | $W \leq 0.02$    | ignore | A+B  | $L \leq 3.0$            | $0.02 < W \leq 0.03$ | 2    | A+B                     | $L \leq 2.5$ | $0.03 < W \leq 0.05$ | A+B           | --- | $0.05 < W$ | As round type |   | 2.5 |     |
| Length  | Width  | Acceptable QTY   | Zone           |                |      |                  |        |      |                         |                      |      |                         |              |                      |               |     |            |               |   |     |     |
| ---   | $W \leq 0.02$  | ignore   | A+B            |                |      |                  |        |      |                         |                      |      |                         |              |                      |               |     |            |               |   |     |     |
| $L \leq 3.0$  | $0.02 < W \leq 0.03$                                       | 2  | A+B            |                |      |                  |        |      |                         |                      |      |                         |              |                      |               |     |            |               |   |     |     |
| $L \leq 2.5$  | $0.03 < W \leq 0.05$                                       |  | A+B            |                |      |                  |        |      |                         |                      |      |                         |              |                      |               |     |            |               |   |     |     |
| ---   | $0.05 < W$   | As round type  |                |                |      |                  |        |      |                         |                      |      |                         |              |                      |               |     |            |               |   |     |     |
| 04  | Polarizer Bubbles /Dent                                    | 4.1 If bubbles are visible, judge using black spot specifications, not easy to find, must check in specify direction. <table border="1" data-bbox="694 1355 1350 1648"> <thead> <tr> <th>Size <math>\Phi</math></th> <th>Acceptable QTY</th> <th>Zone</th> </tr> </thead> <tbody> <tr> <td><math>\Phi \leq 0.20</math></td> <td>ignore</td> <td>A+B</td> </tr> <tr> <td><math>0.20 &lt; \Phi \leq 0.50</math></td> <td>3</td> <td>A+B</td> </tr> <tr> <td><math>0.50 &lt; \Phi \leq 1.00</math></td> <td>2</td> <td>A+B</td> </tr> <tr> <td><math>1.00 &lt; \Phi</math></td> <td>0</td> <td>A+B</td> </tr> <tr> <td>Total QTY</td> <td>3</td> <td></td> </tr> </tbody> </table> 4.2 The polarizer dent follows this specification. | Size $\Phi$    | Acceptable QTY | Zone | $\Phi \leq 0.20$ | ignore | A+B  | $0.20 < \Phi \leq 0.50$ | 3                    | A+B  | $0.50 < \Phi \leq 1.00$ | 2            | A+B                  | $1.00 < \Phi$ | 0   | A+B        | Total QTY     | 3 |     | 2.5 |
| Size $\Phi$   | Acceptable QTY   | Zone   |                |                |      |                  |        |      |                         |                      |      |                         |              |                      |               |     |            |               |   |     |     |
| $\Phi \leq 0.20$  | ignore   | A+B  |                |                |      |                  |        |      |                         |                      |      |                         |              |                      |               |     |            |               |   |     |     |
| $0.20 < \Phi \leq 0.50$   | 3  | A+B  |                |                |      |                  |        |      |                         |                      |      |                         |              |                      |               |     |            |               |   |     |     |
| $0.50 < \Phi \leq 1.00$   | 2  | A+B  |                |                |      |                  |        |      |                         |                      |      |                         |              |                      |               |     |            |               |   |     |     |
| $1.00 < \Phi$   | 0  | A+B  |                |                |      |                  |        |      |                         |                      |      |                         |              |                      |               |     |            |               |   |     |     |
| Total QTY   | 3  |  |                |                |      |                  |        |      |                         |                      |      |                         |              |                      |               |     |            |               |   |     |     |
| 05  | Scratches  | Follow NO.3 OLED black spots, white spots, contamination.  |                |                |      |                  |        |      |                         |                      |      |                         |              |                      |               |     |            |               |   |     |     |

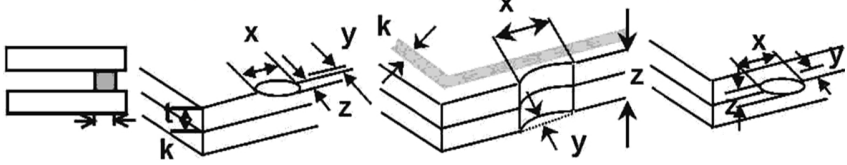
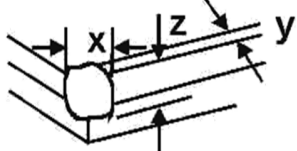
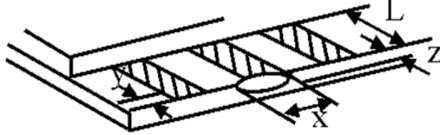
| NO                    | Item  | Criterion  | AQL               |                |                   |                       |                       |                    |                    |                 |               |     |
|-----------------------|---|--|-------------------|----------------|-------------------|-----------------------|-----------------------|--------------------|--------------------|-----------------|---------------|-----|
| 06                    | Chipped Glass   | <p>Symbols Define:<br/>                     x: Chip length            y: Chip width            z: Chip thickness<br/>                     k: Seal width            t: Glass thickness    a: OLED side length<br/>                     L: Electrode pad length:<br/>                     6.1 General glass chip :<br/>                     6.1.1 Chip on panel surface and crack between panels:</p>  <table border="1" data-bbox="432 712 1318 860"> <thead> <tr> <th>z: Chip thickness</th> <th>y: Chip width</th> <th>x: Chip length</th> </tr> </thead> <tbody> <tr> <td><math>Z \leq 1/2t</math></td> <td>Not over viewing area</td> <td><math>x \leq 1/8a</math></td> </tr> <tr> <td><math>1/2t &lt; z \leq 2t</math></td> <td>Not exceed 1/3k</td> <td><math>x \leq 1/8a</math></td> </tr> </tbody> </table> <p>⊙If there are 2 or more chips, x is total length of each chip.</p> | z: Chip thickness | y: Chip width  | x: Chip length    | $Z \leq 1/2t$         | Not over viewing area | $x \leq 1/8a$      | $1/2t < z \leq 2t$ | Not exceed 1/3k | $x \leq 1/8a$ | 2.5 |
|                       | z: Chip thickness   | y: Chip width  | x: Chip length    |                |                   |                       |                       |                    |                    |                 |               |     |
| $Z \leq 1/2t$         | Not over viewing area   | $x \leq 1/8a$  |                   |                |                   |                       |                       |                    |                    |                 |               |     |
| $1/2t < z \leq 2t$    | Not exceed 1/3k   | $x \leq 1/8a$  |                   |                |                   |                       |                       |                    |                    |                 |               |     |
|                       | <p>6.1.2 Corner crack:</p>  <table border="1" data-bbox="432 1182 1337 1330"> <thead> <tr> <th>z: Chip thickness</th> <th>y: Chip width</th> <th>x: Chip length</th> </tr> </thead> <tbody> <tr> <td><math>Z \leq 1/2t</math></td> <td>Not over viewing area</td> <td><math>x \leq 1/8a</math></td> </tr> <tr> <td><math>1/2t &lt; z \leq 2t</math></td> <td>Not exceed 1/3k</td> <td><math>x \leq 1/8a</math></td> </tr> </tbody> </table> <p>⊙If there are 2 or more chips, x is the total length of each chip.</p> | z: Chip thickness  | y: Chip width     | x: Chip length | $Z \leq 1/2t$     | Not over viewing area | $x \leq 1/8a$         | $1/2t < z \leq 2t$ | Not exceed 1/3k    | $x \leq 1/8a$   | 2.5           |     |
| z: Chip thickness     | y: Chip width   | x: Chip length   |                   |                |                   |                       |                       |                    |                    |                 |               |     |
| $Z \leq 1/2t$         | Not over viewing area   | $x \leq 1/8a$  |                   |                |                   |                       |                       |                    |                    |                 |               |     |
| $1/2t < z \leq 2t$    | Not exceed 1/3k   | $x \leq 1/8a$  |                   |                |                   |                       |                       |                    |                    |                 |               |     |
|                       | Glass Crack   | <p>Symbols :<br/>                     x: Chip length            y: Chip width            z: Chip thickness<br/>                     k: Seal width            t: Glass thickness    a: OLED side length<br/>                     L: Electrode pad length<br/>                     6.2 Protrusion over terminal :<br/>                     6.2.1 Chip on electrode pad :</p>  <table border="1" data-bbox="432 1778 1318 1872"> <thead> <tr> <th>y: Chip width</th> <th>x: Chip length</th> <th>z: Chip thickness</th> </tr> </thead> <tbody> <tr> <td><math>y \leq 0.5\text{mm}</math></td> <td><math>x \leq 1/8a</math></td> <td><math>0 &lt; z \leq t</math></td> </tr> </tbody> </table>  | y: Chip width     | x: Chip length | z: Chip thickness | $y \leq 0.5\text{mm}$ | $x \leq 1/8a$         | $0 < z \leq t$     | 2.5                |                 |               |     |
| y: Chip width         | x: Chip length  | z: Chip thickness  |                   |                |                   |                       |                       |                    |                    |                 |               |     |
| $y \leq 0.5\text{mm}$ | $x \leq 1/8a$   | $0 < z \leq t$   |                   |                |                   |                       |                       |                    |                    |                 |               |     |

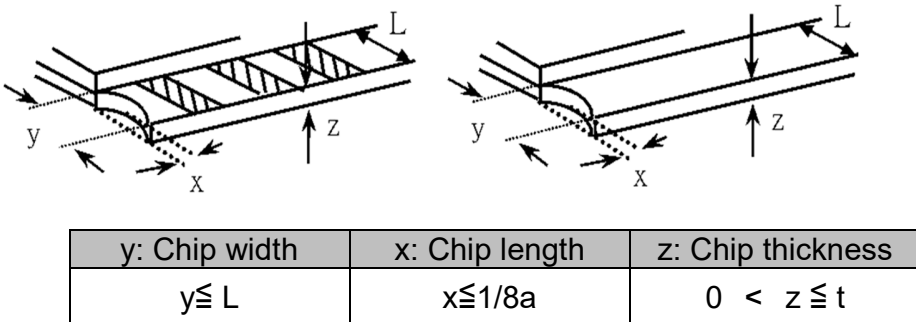
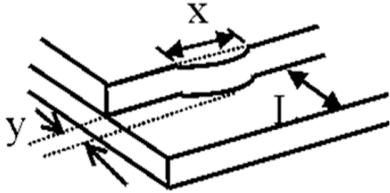
| NO            | Item               | Criterion   | AQL                 |                |                   |            |               |                |          |           |               |            |     |
|---------------|--------------------|---|---------------------|----------------|-------------------|------------|---------------|----------------|----------|-----------|---------------|------------|-----|
| 06            | Glass Crack        | <p>6.2.2 Non-conductive portion:</p>  <table border="1" data-bbox="499 589 1358 680"> <thead> <tr> <th>y: Chip width</th> <th>x: Chip length</th> <th>z: Chip thickness</th> </tr> </thead> <tbody> <tr> <td><math>y \leq L</math></td> <td><math>x \leq 1/8a</math></td> <td><math>0 &lt; z \leq t</math></td> </tr> </tbody> </table> <p>⊙If the chipped area touches the ITO terminal, over 2/3 of the ITO must remain and be inspected according to electrode terminal specifications.</p> <p>⊙If the product will be heat sealed by the customer, the alignment mark not be damaged.</p> <p>6.2.3 Substrate protuberance and internal crack.</p> <table border="1" data-bbox="828 983 1323 1075"> <thead> <tr> <th>y: width</th> <th>x: length</th> </tr> </thead> <tbody> <tr> <td><math>y \leq 1/3L</math></td> <td><math>x \leq a</math></td> </tr> </tbody> </table>  | y: Chip width       | x: Chip length | z: Chip thickness | $y \leq L$ | $x \leq 1/8a$ | $0 < z \leq t$ | y: width | x: length | $y \leq 1/3L$ | $x \leq a$ | 2.5 |
| y: Chip width | x: Chip length     | z: Chip thickness   |                     |                |                   |            |               |                |          |           |               |            |     |
| $y \leq L$    | $x \leq 1/8a$      | $0 < z \leq t$  |                     |                |                   |            |               |                |          |           |               |            |     |
| y: width      | x: length          |   |                     |                |                   |            |               |                |          |           |               |            |     |
| $y \leq 1/3L$ | $x \leq a$         |   |                     |                |                   |            |               |                |          |           |               |            |     |
| 07            | Cracked Glass      | The OLED with extensive crack is not acceptable.  | 2.5                 |                |                   |            |               |                |          |           |               |            |     |
| 08            | Backlight Elements | <p>8.1 Illumination source flickers when lit.</p> <p>8.2 Spots or scratched that appear when lit must be judged. Using OLED spot, lines and contamination standards.</p> <p>8.3 Backlight doesn't light or color wrong.</p>   | 0.65<br>2.5<br>0.65 |                |                   |            |               |                |          |           |               |            |     |
| 09            | Bezel              | <p>9.1 Bezel may not have rust, be deformed or have fingerprints, stains or other contamination.</p> <p>9.2 Bezel must comply with job specifications.</p>  | 2.5<br>0.65         |                |                   |            |               |                |          |           |               |            |     |

| NO | Item               | Criterion  | AQL  |
|----|--------------------|--|------|
| 10 | PCB , COB          | 10.1 COB seal may not have pinholes larger than 0.2mm or contamination.  | 2.5  |
|    |                    | 10.2 COB seal surface may not have pinholes through to the IC.   | 2.5  |
|    |                    | 10.3 The height of the COB should not exceed the height indicated in the assembly diagram.   | 0.65 |
|    |                    | 10.4 There may not be more than 2mm of sealant outside the seal area on the PCB. And there should be no more than three places.              | 2.5  |
|    |                    | 10.5 No oxidation or contamination PCB terminals.  | 2.5  |
|    |                    | 10.6 Parts on PCB must be the same as on the production characteristic chart. There should be no wrong parts, missing parts or excess parts. | 0.65 |
|    |                    | 10.7 The jumper on the PCB should conform to the product characteristic chart.   | 0.65 |
|    |                    | 10.8 If solder gets on bezel tab pads, OLED pad, zebra pad or screw hold pad, make sure it is smoothed down.                                 | 2.5  |
| 11 | Soldering          | 11.1 No un-melted solder paste may be present on the PCB.  | 2.5  |
|    |                    | 11.2 No cold solder joints, missing solder connections, oxidation or icicle.   | 2.5  |
|    |                    | 11.3 No residue or solder balls on PCB.  | 2.5  |
|    |                    | 11.4 No short circuits in components on PCB.   | 0.65 |
| 12 | General Appearance | 12.1 No oxidation, contamination, curves or, bends on interface Pin (OLB) of TCP.  | 2.5  |
|    |                    | 12.2 No cracks on interface pin (OLB) of TCP.  | 0.65 |
|    |                    | 12.3 No contamination, solder residue or solder balls on product.  | 2.5  |
|    |                    | 12.4 The IC on the TCP may not be damaged, circuits.   | 2.5  |
|    |                    | 12.5 The uppermost edge of the protective strip on the interface pin must be present or look as if it cause the interface pin to sever.      | 2.5  |
|    |                    | 12.6 The residual rosin or tin oil of soldering (component or chip component) is not burned into brown or black color.                       | 2.5  |
|    |                    | 12.7 Sealant on top of the ITO circuit has not hardened.   | 2.5  |
|    |                    | 12.8 Pin type must match type in specification sheet.  | 0.65 |
|    |                    | 12.9 OLED pin loose or missing pins.   | 0.65 |
|    |                    | 12.10 Product packaging must the same as specified on packaging specification sheet.   | 0.65 |
|    |                    | 12.11 Product dimension and structure must conform to product specification sheet.   | 0.65 |

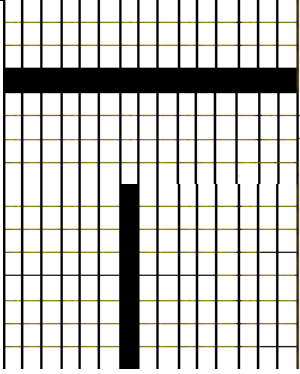
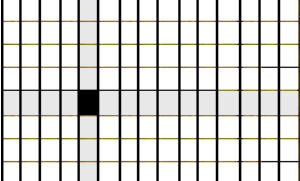
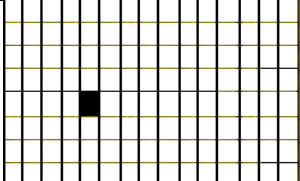
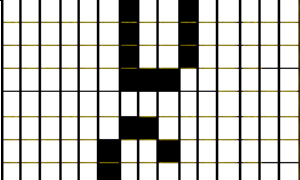
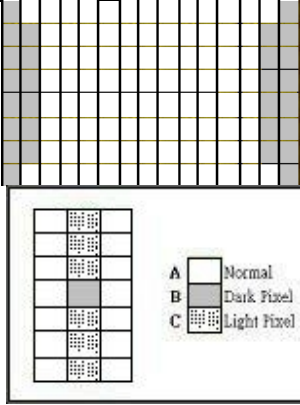

| Check Item   | Classification | Criteria   |
|--|----------------|--|
| No Display   | Major          |    |
| Missing Line   | Major          |    |
| Pixel Short  | Major          |   |
| Darker Short   | Major          |  |
| Wrong Display  | Major          |  |
| Un-uniform<br>$B/A \times 100\% < 70\%$<br>$A/C \times 100\% < 70\%$ | Major          |  |

## **10. Precautions in use of OLED Modules**

### **Modules**

- (1) Avoid applying excessive shocks to module or making any alterations or modifications to it.
- (2) Don't make extra holes on the printed circuit board, change the components or modify its shape of OLED display module.
- (3) Don't disassemble the OLED display module.
- (4) Do not apply input signals while the logic power is off.
- (5) Don't operate it above the absolute maximum rating.
- (6) Don't drop, bend or twist OLED display module.
- (7) Soldering: only to the I/O terminals.
- (8) Hot-Bar FPC soldering condition: 280~350C, less than 5 seconds.
- (9) Display Elektronik GmbH has the right to change the passive components (Resistors, capacitors and other passive components will have different appearance and color caused by the different supplier.) and change the PCB Rev. (In order to satisfy the supplying stability, management optimization and the best product performance...etc, under the premise of not affecting the electrical characteristics and external dimensions, Display Elektronik GmbH have the right to modify the version.)
- (10) Display Elektronik GmbH has the right to upgrade or modify the product function.

#### **10.1. Handling Precautions**

- (1) Since the display panel is being made of glass, do not apply mechanical impacts such as dropping from a high position.
- (2) If the display panel is broken by some accident and the internal organic substance leaks out, be careful not to inhale nor lick the organic substance.
- (3) If pressure is applied to the display surface or its neighborhood of the OLED display module, the cell structure may be damaged. So, be careful not to apply pressure to these sections.
- (4) The polarizer covering the surface of the OLED display module is soft and easily scratched.
- (5) When the surface of the polarizer of the OLED display module has soil, clean the surface. It takes advantage by using following adhesion tape.
  - \* Scotch Mending Tape No. 810 or an equivalentNever try to breathe upon the soiled surface nor wipe the surface using cloth containing solvent such as ethyl alcohol, since the surface of the polarizer will become cloudy. Also, pay attention that the following liquid and solvent may spoil the polarizer:
  - \* Water
  - \* Ketone
  - \* Aromatic Solvents
- (6) Protection film is being applied to the surface of the display panel and removes the protection film before assembling it. At this time, if the OLED display module has been stored for a long period of time, residue adhesive material of the protection film may remain on the surface of the display panel after removed of the film. In such case, remove the residue material by the method introduced in the above Section 5.
- (7) Do not touch the following sections whenever possible while handling the OLED display modules.
  - \* Pins and electrodes
  - \* Pattern layouts such as the TCP & FPC
- (8) Hold OLED display module very carefully when placing OLED display module into the System housing. Do not apply excessive stress or pressure to OLED display module. And,

do not over bend the film with electrode pattern layouts. These stresses will influence the display performance. Also, secure sufficient rigidity for the outer cases.

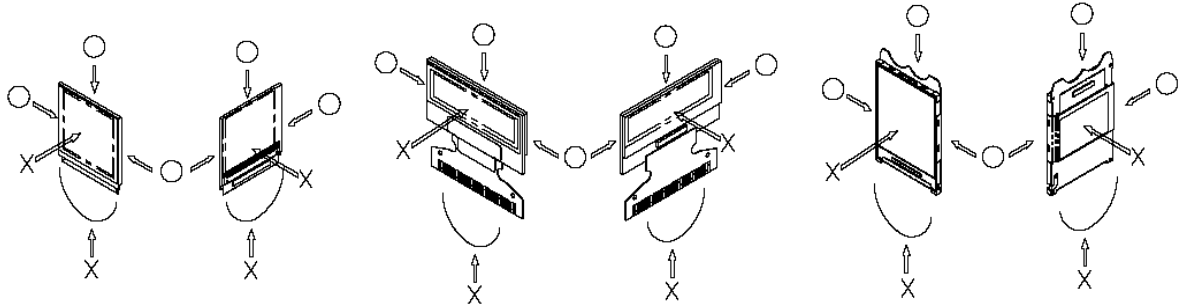

- (9) Do not apply stress to the LSI chips and the surrounding molded sections.
- (10) Pay sufficient attention to the working environments when handing OLED display modules to prevent occurrence of element breakage accidents by static electricity.
  - \* Be sure to make human body grounding when handling OLED display modules.
  - \* Be sure to ground tools to use or assembly such as soldering irons.
  - \* To suppress generation of static electricity, avoid carrying out assembly work under dry environments.
  - \* Protective film is being applied to the surface of the display panel of the OLED display module. Be careful since static electricity may be generated when exfoliating the protective film.

## 10.2. Storage Precautions

- (1) When storing OLED display modules, put them in static electricity preventive bags to avoid be directly exposed to sun or lights of fluorescent lamps. And, also, place in the temperature  $25\pm 5^{\circ}\text{C}$  and Humidity below 65% RH.(We recommend you to store these modules in the packaged state when they were shipped from Winstar. At that time, be careful not to let water drops adhere to the packages or bags.)
- (2) When the OLED display module is being dewed or when it is placed under high temperature or high humidity environments, the electrodes may be corroded if electric current is applied. Please store it in clean environment.

## 10.3. Designing Precautions

- (1) The absolute maximum ratings are the ratings which cannot be exceeded for OLED display module, and if these values are exceeded, OLED display module may be damaged.
- (2) To prevent occurrence of malfunctioning by noise, pay attention to satisfy the VIL and VIH specification and to make the signal line cable as short as possible.
- (3) We recommend you to install excess current preventive unit (fuses, etc.) to the power circuit (VDD / VCC). (Recommend value: 0.5A)
- (4) Pay sufficient attention to avoid occurrence of mutual noise interference with the nearby devices.
- (5) As for EMI, take necessary measures on the equipment side basically.
- (6) If the power supplied to the OLED display module is forcibly shut down by such errors as taking out the main battery while the OLED display panel is in operation, we cannot guarantee the quality of this OLED display module.
  - \* Connection (contact) to any other potential than the above may lead to rupture of the IC.
- (7) If this OLED driver is exposed to light, malfunctioning may occur and semiconductor elements may change their characteristics.
- (8) The internal status may be changed, if excessive external noise enters into the module.

Therefore, it is necessary to take appropriate measures to suppress noise generation or to protect module from influences of noise on the system design.

- (9) We recommend you to make periodical refreshment of the operation statuses (re-setting of the commands and re-transference of the display data) to cope with catastrophic noise.
- (10) It's pretty common to use "Screen Saver" to extend the lifetime and Don't use the same image for long time in real application. When an OLED display module is operated for a long of time with fixed pattern, an afterimage or slight contrast deviation may occur.
- (11) The limitation of FPC and Film bending.

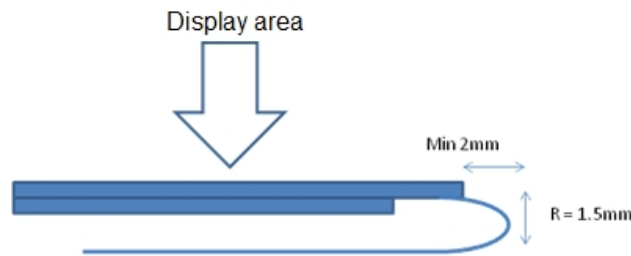

- (12) The module should be fixed balanced into the housing, or the module may be twisted.

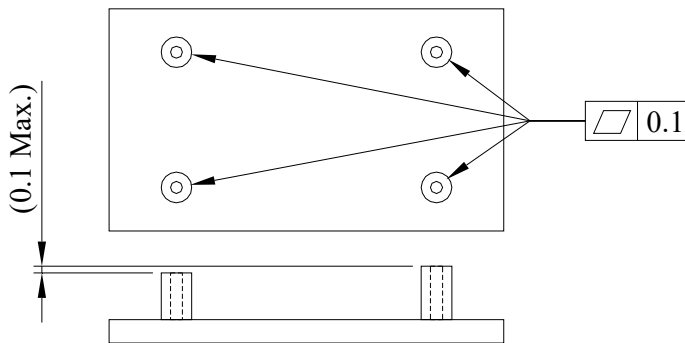

- (13) Please heat up a little the tape sticking on the components when removing it; otherwise the components might be damaged.

**10.4. Precautions when disposing of the OLED display modules**

- (1) Request the qualified companies to handle industrial wastes when disposing of the OLED display modules. Or, when burning them, be sure to observe the environmental and hygienic laws and regulations.