

DC-Filter, dual pole



Approvals and Compliances

Description

- Line-filter in standard version
- 1-stage
- standard attenuation

Characteristics

- Optimized for DC supplied applications
- Suitable for use in equipment according to IEC/UL 60950

Other versions on request

- Other terminal combinations
- Version with wire connection

References

Alternative: Standard version

Weblinks

[pdf datasheet](#), [html-datasheet](#), [General Product Information](#), [Distributor-Stock-Check](#), [Detailed request for product](#), [Microsite](#)

Technical Data

Ratings IEC	5 - 30A @ Ta 40 °C / ±80VDC
Ratings UL/CSA	5 - 30A @ Ta 40 °C / ±80VDC
Dielectric Strength	> 1.7 kVDC between Vss-GND
	> 2.7 kVDC between Vss/GND-PE Test voltage (2 sec)
Allowable Operation Temperature	-25 °C to 100 °C
Climatic Category	25/100/21 acc. to IEC 60068-1
Protection Class	Suitable for appliances with protection class I acc. to IEC 61140
Terminal	Quick connect and screw terminals
Material: Housing	Aluminum, UL 94V-0

Line Filter	Industrial Version, IEC 60939, UL 1283, CSA C22.2 no. 8 Technical Details
MTBF	> 200'000h acc. to MIL-HB-217 F



Approvals and Compliances

Detailed information on product approvals, code requirements, usage instructions and detailed test conditions can be looked up in [Details about Approvals](#)

Approvals







The approval mark is used by the testing authorities to certify compliance with the safety requirements placed on electronic products.

Approval Reference Type: FMEC

Approval Logo	Certificates	Certification Body	Description
	VDE Approvals	VDE	Certificate Number: 40020247
	UL Approvals	UL	UL File Number: E72928

Product standards

Product standards that are referenced

Organization	Design	Standard	Description
	Designed according to	IEC 60320-1	Appliance couplers for household and similar general purposes
	Designed according to	IEC 60939	Passive filters for suppressing electromagnetic interference
	Designed according to	IEC 60127-6	Miniature fuses. Part 6. Fuse-holders for miniature fuse-links
	Designed according to	UL 498	Standard for Attachment Plugs and Receptacles
	Designed according to	UL 1283	Electromagnetic interference filters
	Designed according to	CSA C22.2 no. 42	General Use Receptacles, Attachment Plugs, and Similar Wiring Devices
	Designed according to	CSA C22.2 no. 8	Electromagnetic interference (EMI) filters





Application standards

Application standards where the product can be used

Organization	Design	Standard	Description
	Designed for applications acc.	IEC/UL 60950	IEC 60950-1 includes the basic requirements for the safety of information technology equipment.

Compliances

The product complies with following Guide Lines

Identification	Details	Initiator	Description
	CE declaration of conformity	SCHURTER AG	The CE marking declares that the product complies with the applicable requirements laid down in the harmonisation of Community legislation on its affixing in accordance with EU Regulation 765/2008.
	RoHS	SCHURTER AG	EU Directive RoHS 2011/65/EU
	China RoHS	SCHURTER AG	The law SJ / T 11363-2006 (China RoHS) has been in force since 1 March 2007. It is similar to the EU directive RoHS.
	REACH	SCHURTER AG	On 1 June 2007, Regulation (EC) No 1907/2006 on the Registration, Evaluation, Authorization and Restriction of Chemicals 1 (abbreviated as "REACH") entered into force.

Dimension [mm]

Case 86-3

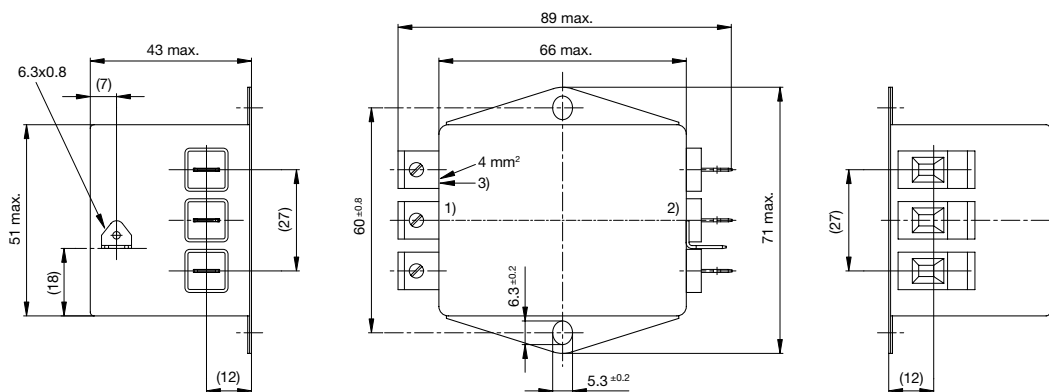

- 1) Line
- 2) Load
- 3) I/O connections torque 0.6...0.8 Nm

Case 87-3

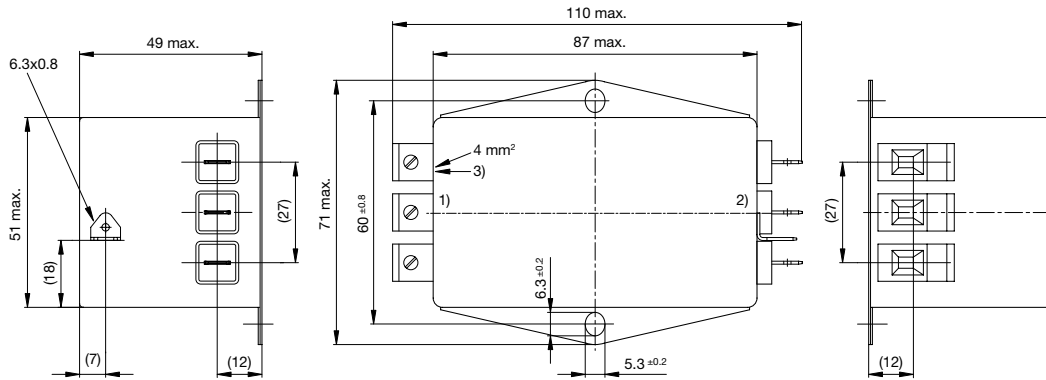

- 1) Line
- 2) Load
- 3) I/O connections torque 0.6...0.8 Nm

Case 87-7

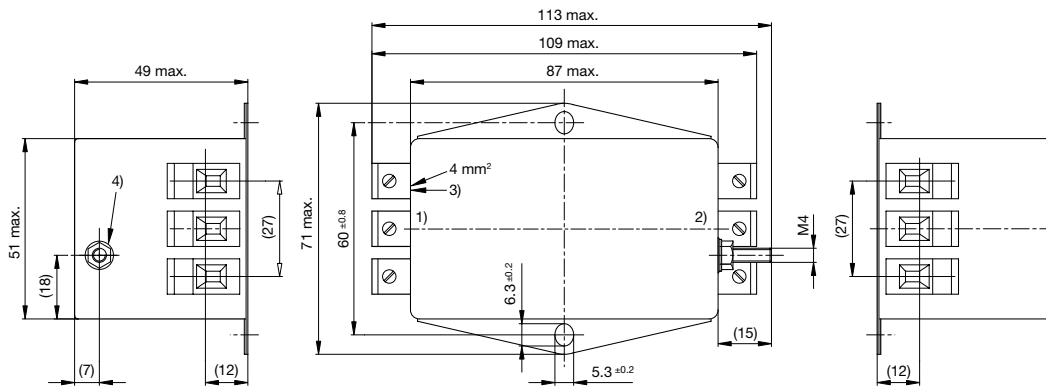

- 1) Line
- 2) Load
- 3) Tightening torque 0.6...0.8 Nm
- 4) Tightening torque 1.2...1.4 Nm

Terminal options

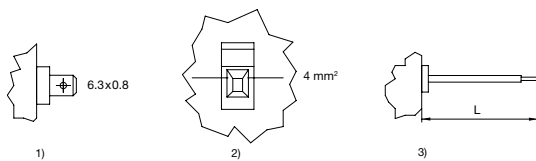

- 1) Quick connect terminals 6.3x0.8 (only up to 24A)
- 2) Screw clamp 4mm²
- 3) Flexible wires

Diagrams

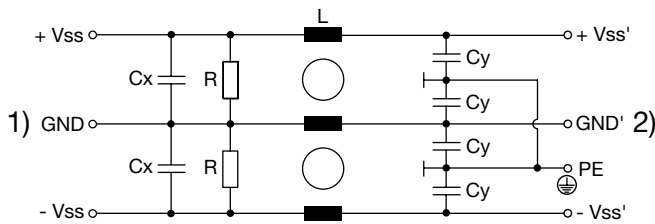

1) Line
 2) Load

Attenuation Loss

--- 50Ω differential mode ____ 50Ω common mode

Standard version

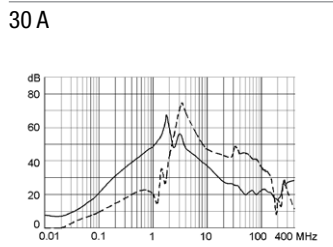
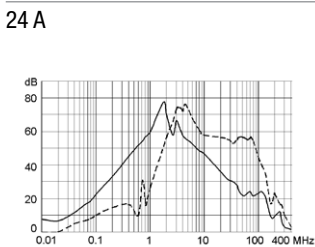
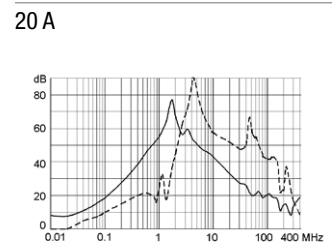
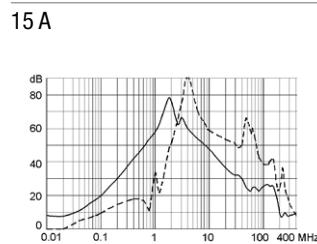
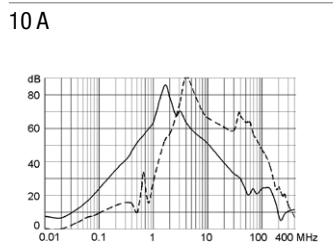
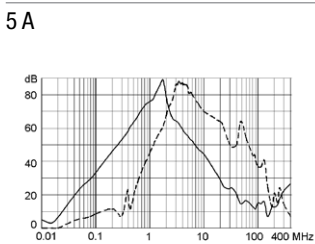

All Variants

Rated Current [A]	L [mH]	Cx (X2) [nF]	Cy (Y2) [nF]	R [MΩ]	Weight [g]	Housings	Packaging unit	Order Number
5	3 x 0.75	100	100	1	245 g	86-3	10	5500.2229
10	3 x 0.2	100	100	1	245 g	86-3	10	5500.2230
15	3 x 0.1	100	100	1	250 g	86-3	10	5500.2231
20	3 x 0.07	100	100	1	260 g	86-3	10	5500.2232
24	3 x 0.14	100	100	1	400 g	87-3	4	5500.2233
30	3 x 0.08	100	100	1	425 g	87-7	4	5500.2234

Most Popular.

Availability for all products can be searched real-time: <https://www.schurter.com/en/Stock-Check/Stock-Check-SCHURTER>