

A

B

C

D

E

1 2 3 4

operating force
Betätigungskraft $F=7N \pm 2.5N$

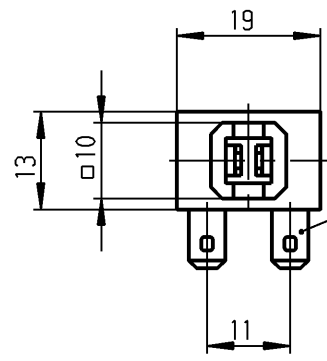
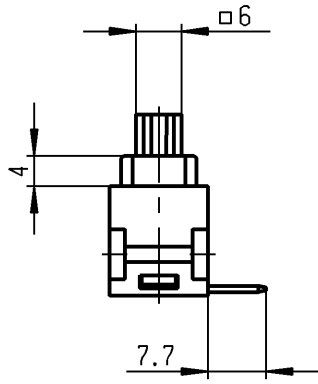
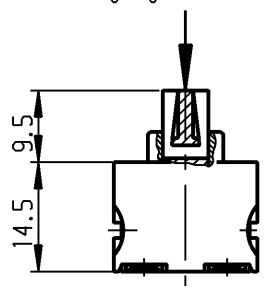

plug in / Flachstecker
ähnl. DIN 46 244-A 4.8-0.8

Marking
Aufschrift

Ⓜ
168..
12(8)/250~ T100/55
10(8)/250~ 5E4



12A 125 - 250 VAC
1/2 HP 125-250 VAC
R 97 
date code of manufacture:
year / week
acc. to DIN EN 60062
Herstelljahr/-woche
nach DIN EN 60062

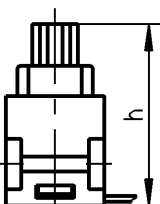
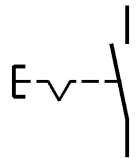



operating position	Schaltstellung	h
OFF	AUS	24.0
ON	EIN	21.3
block	Block	19.7

SPST
suitable for appliances of class II

Ausschalter 1-polig
Für Geräte der Klasse II geeignet

Schutzvermerk
nach DIN 34 beachten
COPYRIGHT RESERVED

Allgemeintoleranzen/UNTOLERANCED DIMENSIONS					PROJECTION 	Pause COPY	Blatt SHEET		Zeichn./DRAWING NO. K 1681.3701
Für Längen und Radien FOR LENGTHS AND RADII. ±	Abmaße in mm Für Nennmaßbereich in mm ALL DIMENSIONS ARE IN MILLIMETRES			Original DIN A4			Maßstab SCALE 1:1		
	bis/UP TO 6	über/OVER 6 bis/UP TO 30	über/OVER 30		0	10		20	30 mm
d	34660	11.09.02 hhe	i						Appliance Switch Geräteschalter
c	23951	09.04.96 RS	h						
b	23240	09.03.95 Sb	g						
a	22973	23.09.94 Sb	f						
			e						
Ausg. ISSUE	Änderung REVISION	gez. DRAWN BY	Ausg. ISSUE	Änderung REVISION	gez. DRAWN BY	Ersatz für/REPLACEMENT OF			 Marquardt GmbH, D-78604 Rietheim-Weilheim