

THIS DOCUMENT IS THE PROPERTY OF
KEYSTONE ELECTRONICS CORP. AND
SHALL NOT BE REPRODUCED, DISTRIBUTED
OR USED AS A BASIS FOR MANUFACTURE
WITHOUT PRIOR WRITTEN PERMISSION
FROM KEYSTONE ELECTRONICS CORP.

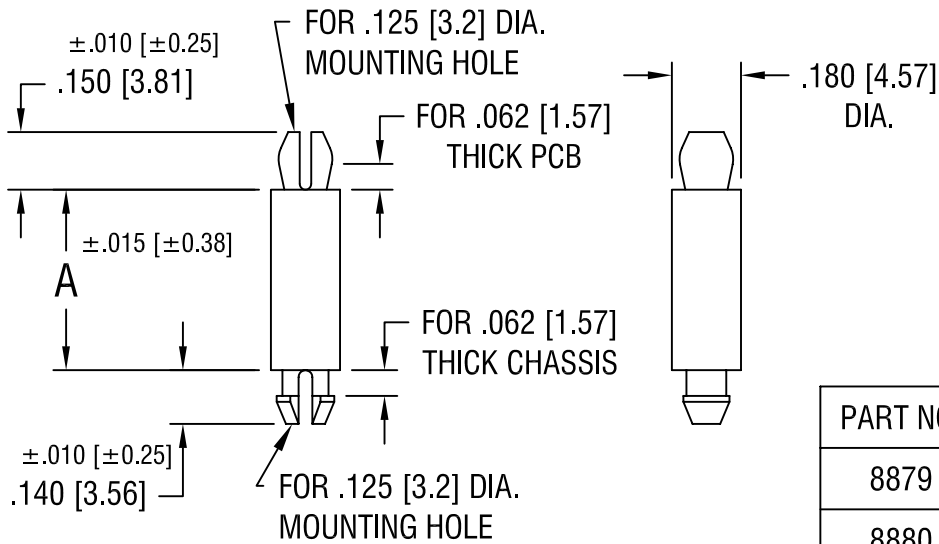

PART NO.	'A' DIM.
8879	.125 [3.18]
8880	.187 [4.75]
8881	.250 [6.35]
8882	.375 [9.52]
8883	.500 [12.70]
8884	.625 [15.87]
8885	.750 [19.05]
8886	.875 [22.22]
8887	1.000 [25.40]

KEYSTONE ELECTRONICS CORP.

ASTORIA, N.Y. 11105-2017

PART NAME		PC LOCK-IN SUPPORT	
MATERIAL		NYLON UL 94V-0	
FINISH	-	DRN BY	BOONE
		DATE	8.29.06
		APP'D	SCALE
			2X
TOLERANCES	INCH [MM]	CODE	DWG NO.
DECIMAL	$\pm .005$ [± 0.15]	C/M	8879-8887
ANGULAR	$\pm 1^\circ$		
UNLESS OTHERWISE SPECIFIED			

DATE	DESCRIPTION	REV.