

Display Elektronik GmbH

DATA SHEET

LCD MODULE

DEM 320240T VMX-PW-N

Product Specification

Version: 2

09.12.2021

GENERAL SPECIFICATION

MODULE NO. :

DEM 320240T VMH-PW-N

CUSTOMER

VERSION NO.	CHANGE DESCRIPTION	DATE
0	ORIGINAL VERSION	22.03.2019
1	ADD RELIABILITY TEXT	04.04.2019
2	CHANGE THE DRAWINGS	09.12.2021

PREPARED BY: YK

DATE: 09.12.2021

APPROVED BY: MH0

DATE: 09.12.2021

CONTENTS

1. GENERAL SPECIFICATIONS	3
2. EXTERNAL DIMENSIONS.....	4
3. BLOCK DIAGRAM	5
4. PIN ASSIGNMENT	6
5. OPTICAL CHARACTERISTICS.....	7
6. ABSOLUTE MAXIMUM RATINGS.....	10
7. ELECTRICAL CHARACTERISTICS.....	10
8. RELIABILITY TEXT	15
9. LCD MODULES HANDLING PRECAUTIONS	16
10. OTHERS.....	16

1. GENERAL SPECIFICATIONS

ITEM	STANDARD VALUE	UNIT
LCD SIZE	3.5	INCH
LCD TYPE	TFT/NORMALLY BLACK	
MODULE SIZE	76.90 x 63.90 x 3.2	MM
ACTIVE AREA	70.08 x 52.56	MM
PIXEL PITCH	0.219 x 0.219	MM
NUMBER OF PIXELS	320 x 240	
DRIVER IC	ST7272A (SITRONIX)	
INTERFACE TYPE	24 BIT-RGB + SPI	
TOP POLARIZER TYPE	Anti-glare	
VIEWING DIRECTION	ALL	O'CLOCK
GRAY SCALE INVERSION DIRECTION	-	O'CLOCK
BACKLIGHT TYPE	6-DIES WHITE LED	
TOUCH PANEL	WITHOUT	

2. EXTERNAL DIMENSIONS

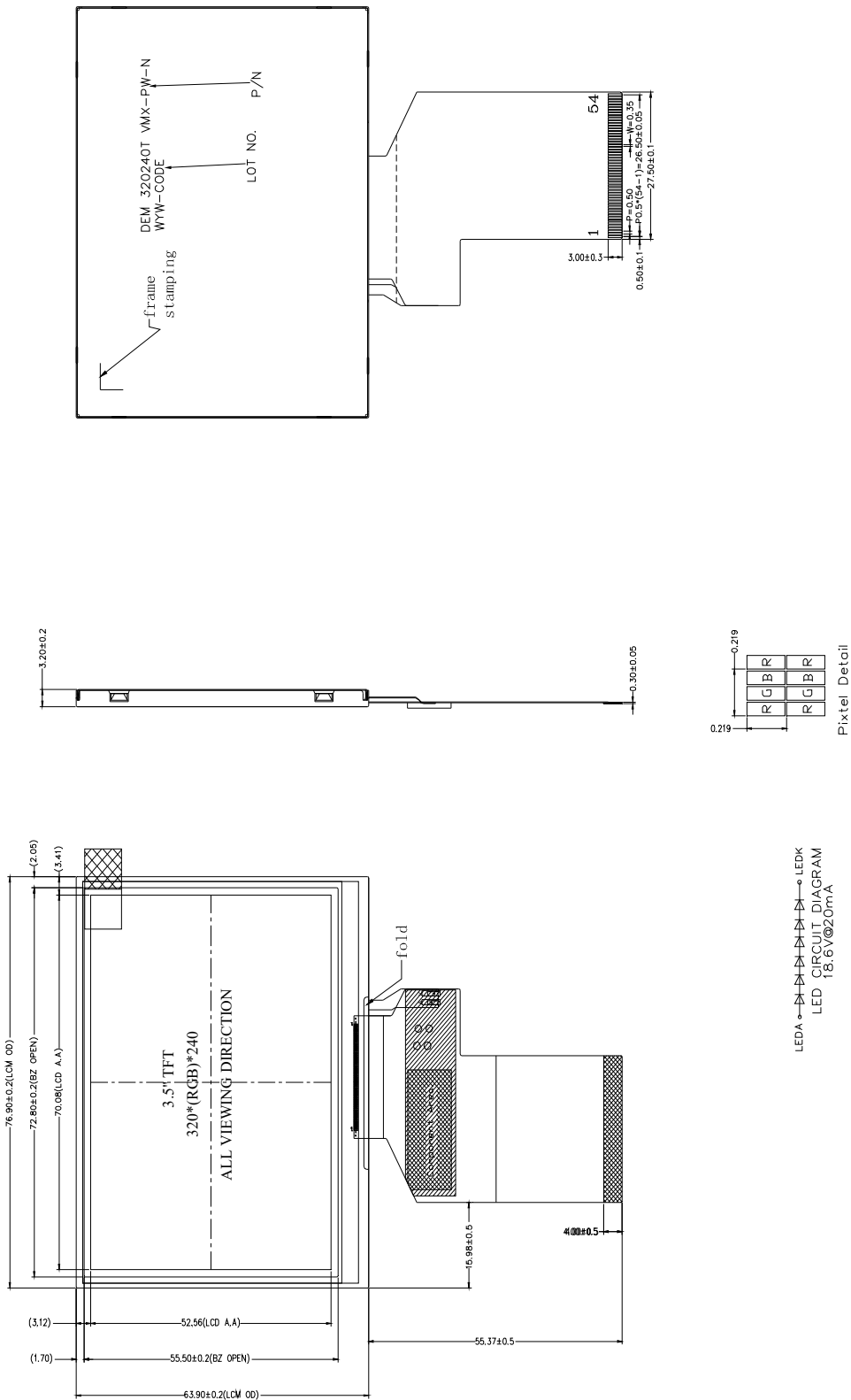

Remark:
 1. All dimensions in mm.
 2. All materials comply with RoHS

3. BLOCK DIAGRAM

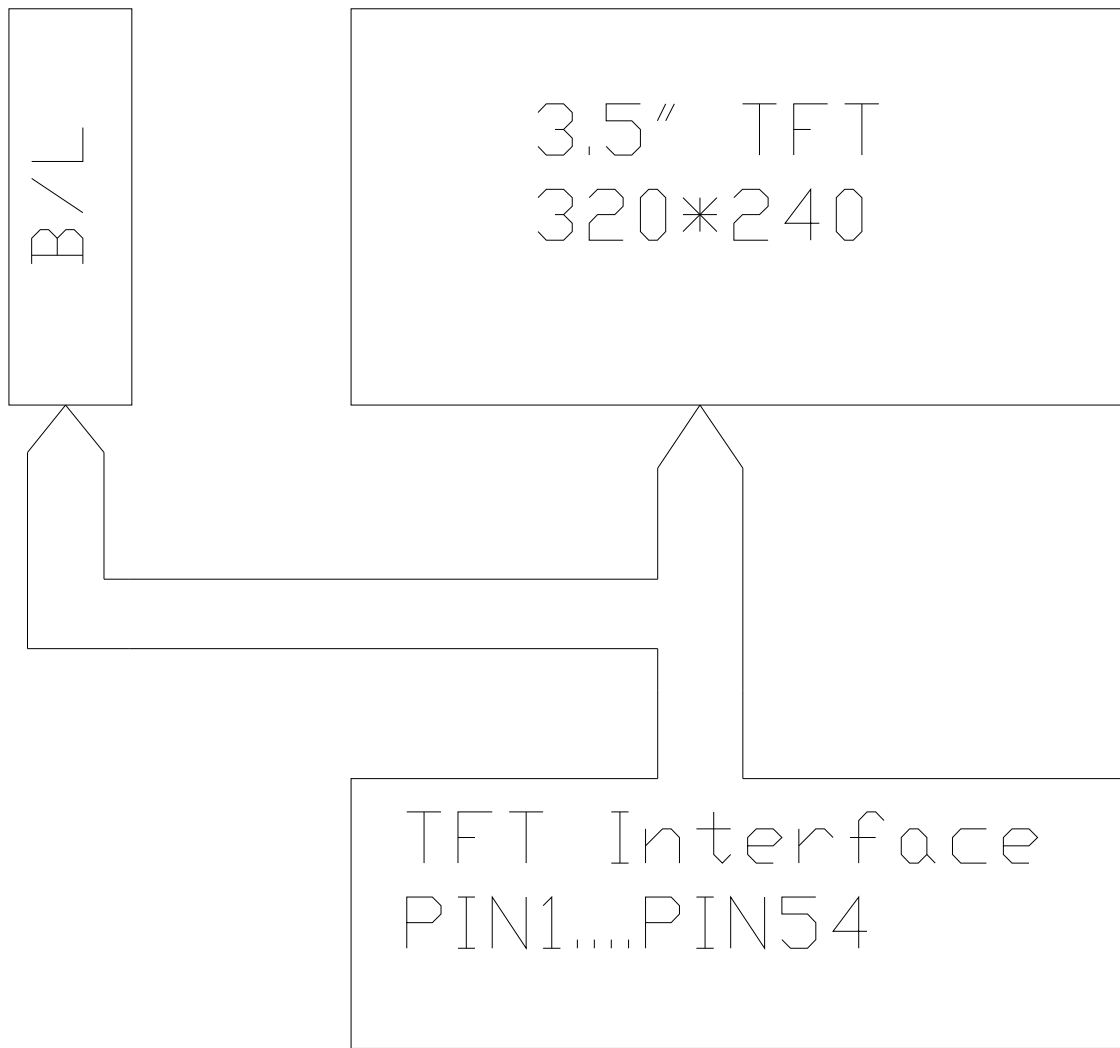

4. PIN ASSIGNMENT

Pin No.	Symbol	Description
1	LEDK	Cathode of LED
2	LEDK	Cathode of LED
3	LEDA	Anode of LED
4	LEDA	Anode of LED
5~7	NC	No connect
8	RESET	Reset pin
9	SPENA	Chip select of serial interface
10	SPCLK	Clock pin of serial interface
11	SPDAT	Data input pin of serial interface
12~19	B0~B7	Blue data bus
20~27	G0~G7	Green data bus
28~35	R0~R7	Red data bus
36	HSYNC	Horizontal sync signal, negative polarity
37	VSYNC	Vertical sync signal, negative polarity
38	DCLK	Clock signal ,latching data at the falling edge
39	NC	No connect
40	NC	No connect
41	VDD	Power supply
42	VDD	Power supply
43~51	NC	No connect
52	DEN	Display enable pin from controller
53	GND	Power ground
54	GND	Power ground

5. OPTICAL CHARACTERISTICS

ITEM	SYMBOL	CONDITIONS	SPECIFICATIONS			UNIT	NOTE
			MIN	TYP.	MAX		
Luminance	L	$I_L=20\text{mA}$	440	550	660	Cd/m ²	
Contrast Ratio	CR	$\theta =0^\circ$	640	800			
Response Time	T _{ON}	25°C		30	40	ms	
	T _{OFF}			30	40		
CIE COLOUR COORDINATE	RED	RX	VIEWING NORMAL ANGLE	0.60	0.62	0.64	
		RY		0.34	0.36	0.38	
	GREEN	GX		0.35	0.37	0.39	
		GY		0.57	0.59	0.61	
	BLUE	BX		0.12	0.14	0.16	
		BY		0.08	0.10	0.12	
	WHITE	WX		0.31	0.33	0.35	
		WY		0.35	0.37	0.39	
VIEWING ANGLE	Hor.	θ_{x+}	CR \geq 10	70	80	Degree	
		θ_{x-}		70	80		
	Ver.	θ_{y+}		70	80		
		θ_{y-}		70	80		
Uniformity	Un		80			%	

Note 1: Definition of Viewing Angle θ_x and θ_y :

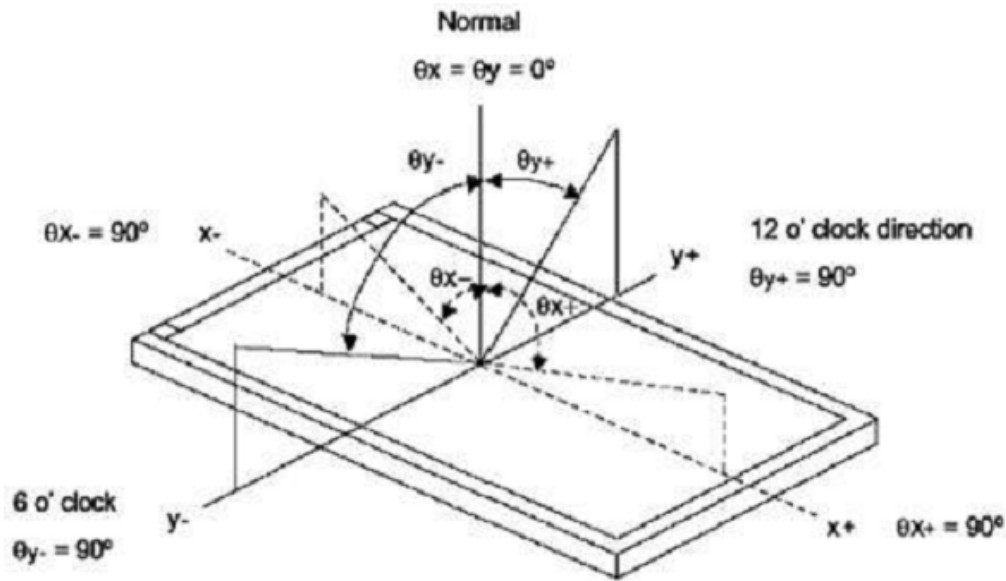

Note 2: Definition of contrast ratio CR:

$$CR = \frac{\text{Luminance of white state}}{\text{Luminance of black state}}$$

Note 3: Definition of Response Time (T_r, T_f)

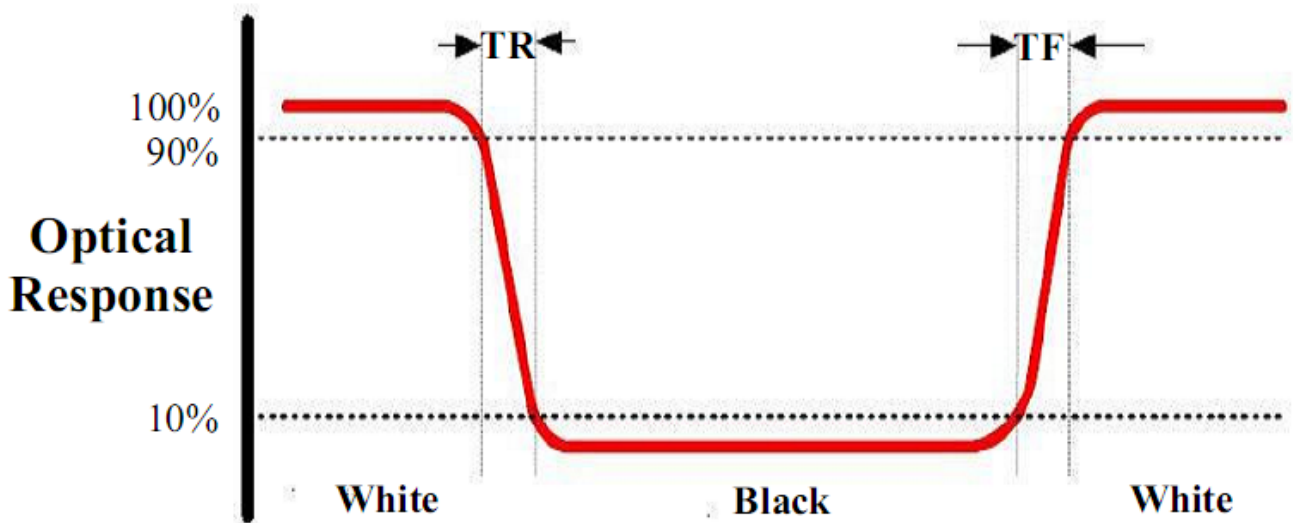

Note 4: Definition of Luminance

① The Brightness Test Equipment Setup

Field=2° (As measuring “black” image, field=2° is the best testing condition)

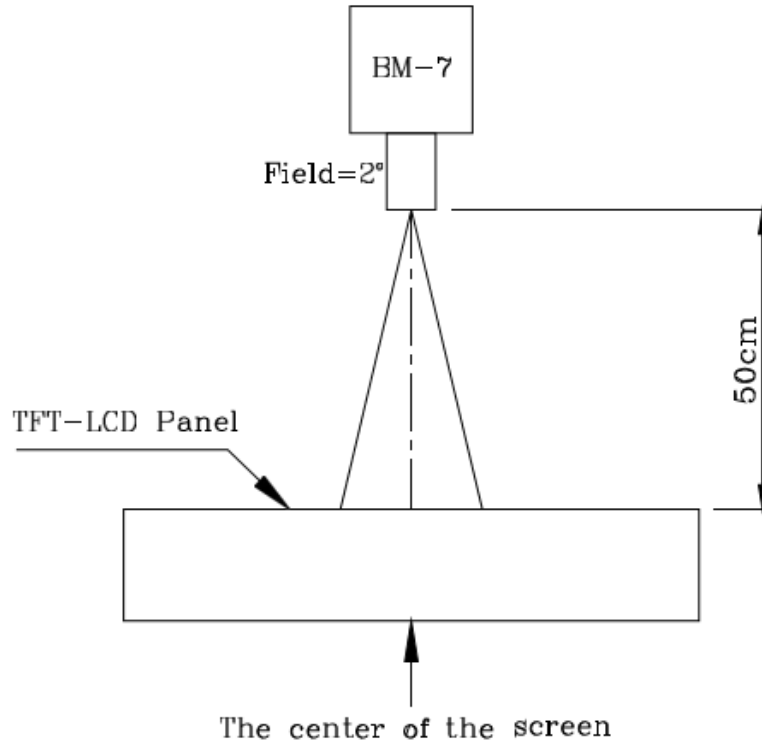

② The Brightness Test Point Setup

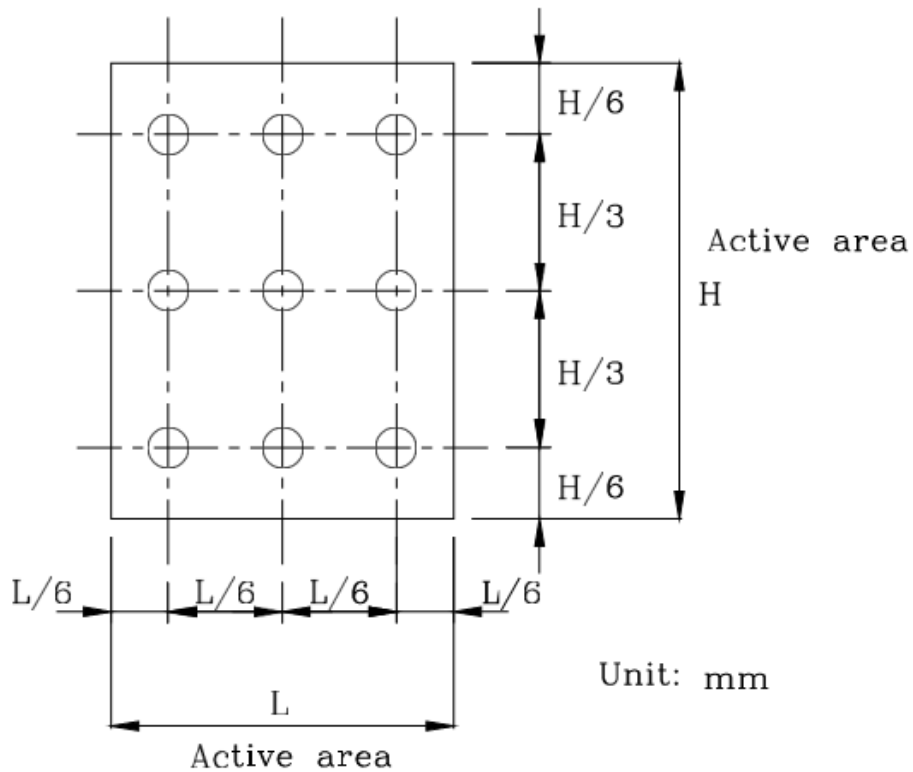

6. ABSOLUTE MAXIMUM RATINGS

PARAMETER	SYMBOL	MIN	MAX	UNIT
Power Supply Voltage	VDD	-0.3	4.5	V
Supply Voltage for Logic	VDD	-0.3	4.5	V
Supply Current (One LED)	I _{LED}		30	mA
Operating Temperature	Top	-30	+85	°C
Storage Temperature	Tst	-30	+85	°C

7. ELECTRICAL CHARACTERISTICS

7.1 Input power

ITEM	SYMBOL	Min	TYP	MAX	UNIT
Supply Voltage for Analog	VDD	3.0	3.3	3.6	V
Supply Voltage for Logic	VDD	3.0	3.3	3.6	V
Input Voltage	V _{IL}	GND	-	0.3VDD	
	V _{IH}	0.7VDD	-	VDD	
Input Leakage Current	I _{LKG}	-1		1	μA

7.2 Backlight Driving Conditions

ITEM	SYMBOL	SPECIFICATIONS			UNIT	Remark
		MIN	TYP.	MAX		
Voltage for LED Backlight	V _f	16.8	18.6	20.4	V	IL=20mA
Current for LED Backlight	I _L		20		mA	
Power Consumption	P		0.375		W	
LED Lifetime		30000	50000		H _r	

7.3 TIMING CHARACTERISTICS

7.3.1 SYNC MODE

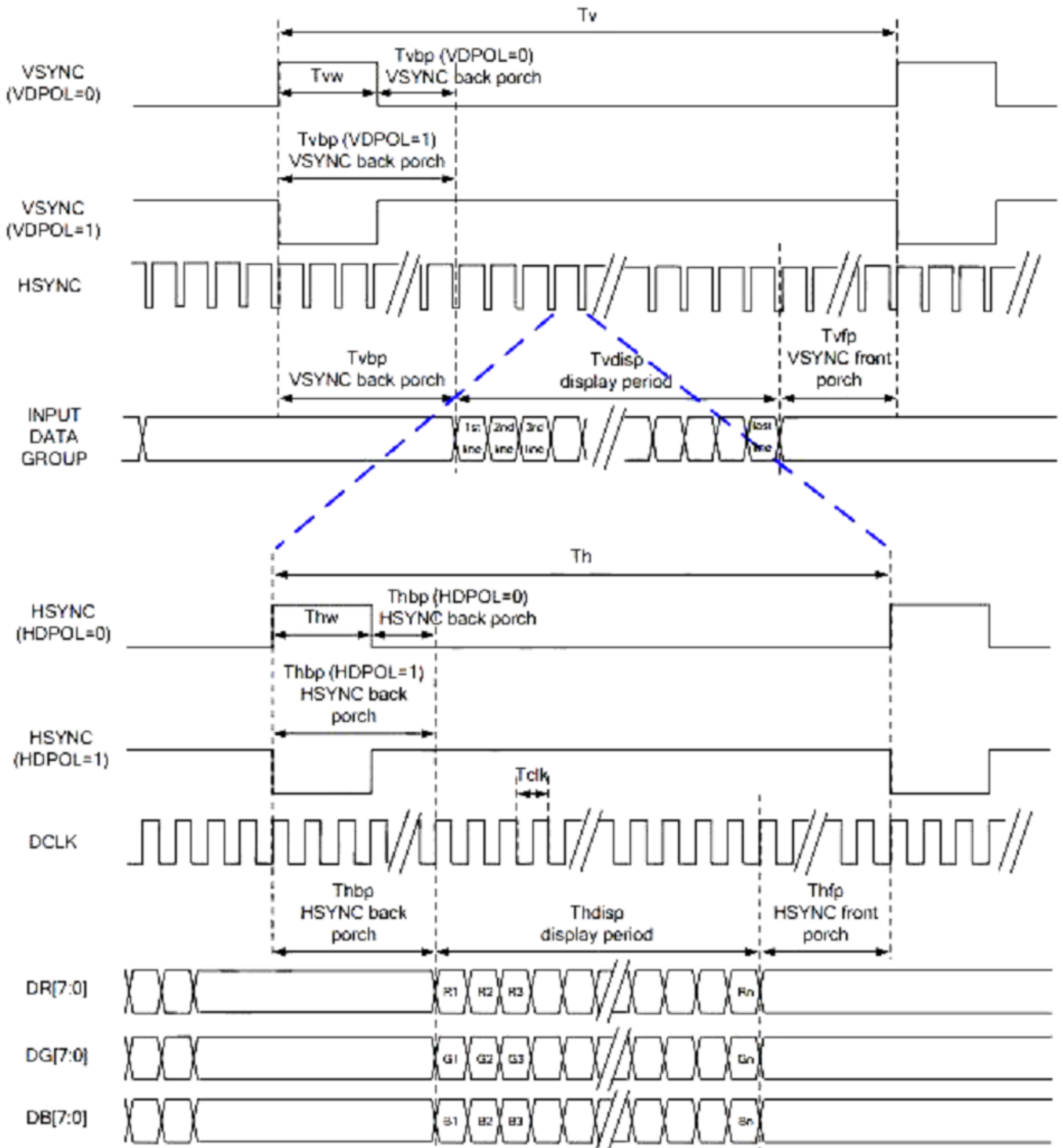

7.3.2 SYNC DE-MODE

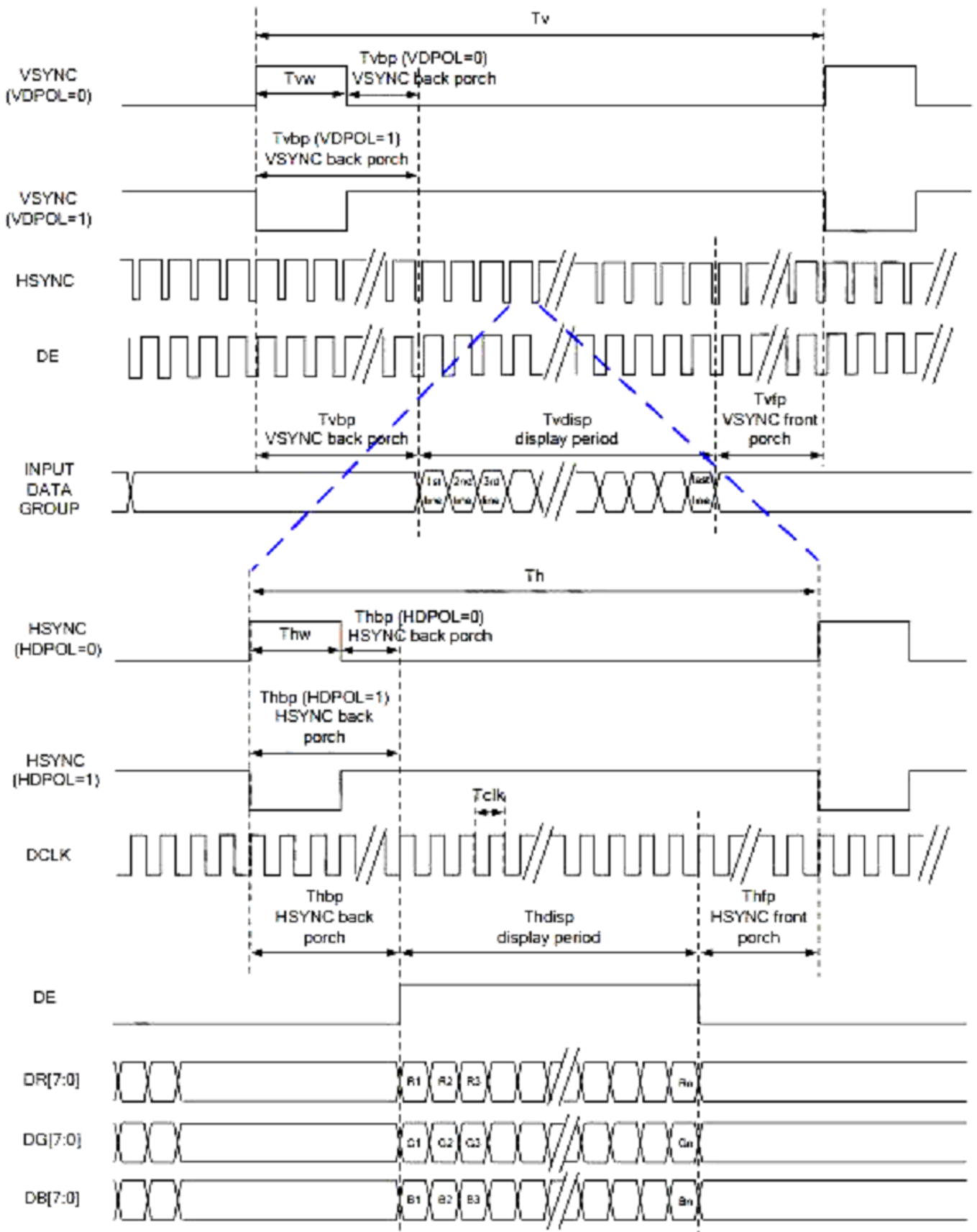

7.3.3 DE MODE

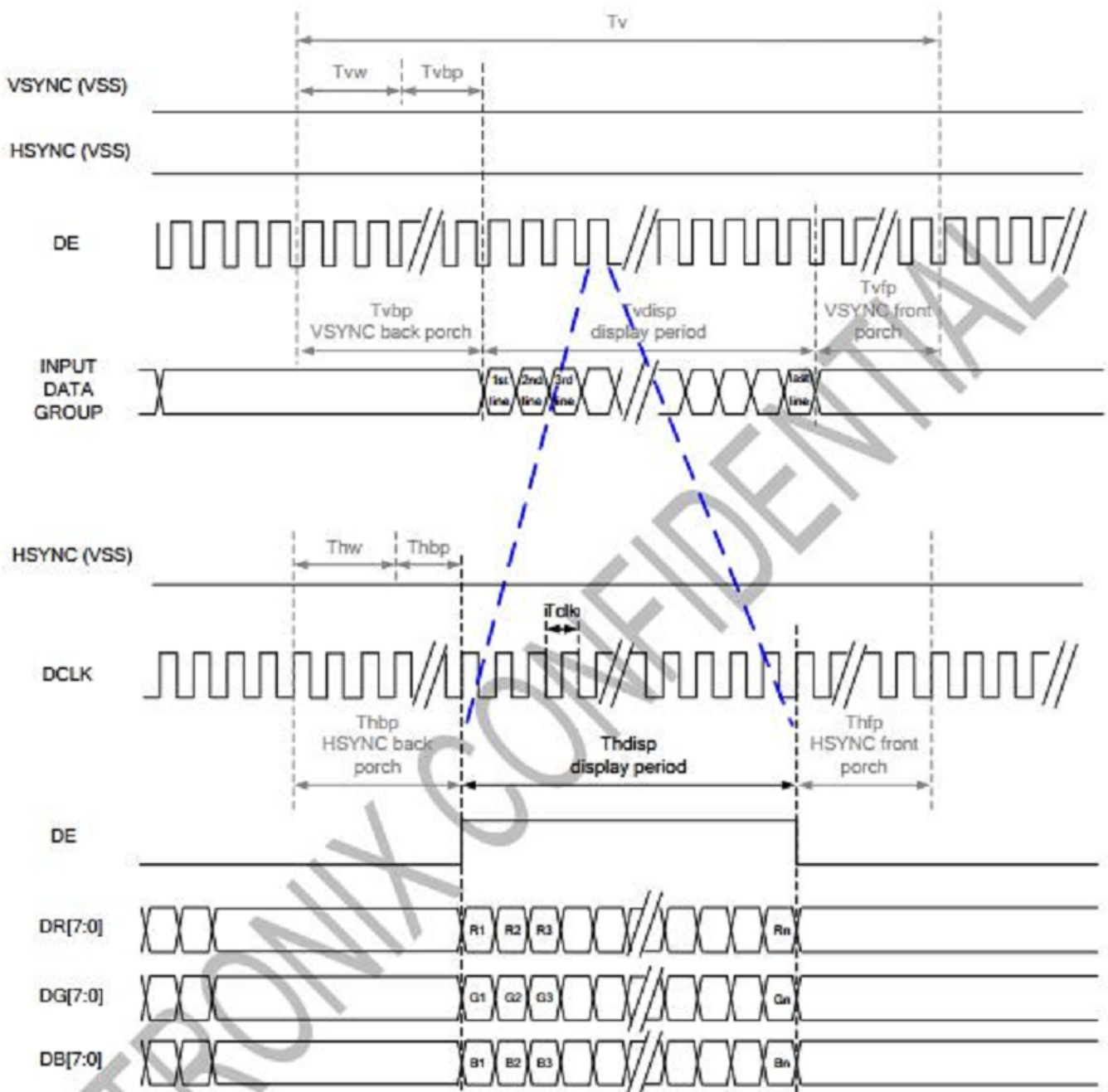

RGB Mode Selection Table	DCLK	HSYNC	VSYNC	DE
SYNC - DE Mode	Input	Input	Input	Input
SYNC Mode	Input	Input	Input	GND
DE Mode	Input	GND	GND	Input

Note: "input" means these signals are driven by host side.

7.3.4 Parallel 24 bit RGB Timing Table

Parallel 24-bit RGB Input Timing (PVDD=VDD=VDDI= 3.3V, AGND= 0V, TA=25°C)

Parallel 24-bit RGB Input Timing Table							
Item	Symbol	Min.	Typ.	Max.	Unit	Remark	
DCLK Frequency	Fclk	5	6	8	MHz		
DCLK Period	Tclk	125	167	200	ns		
HSYNC	Period Time	Th	325	371	438	DCLK	
	Display Period	Thdisp		320		DCLK	
	Back Porch	Thbp	3	43	43	DCLK	By H_BLANKING setting
	Front Porch	Thfp	2	8	75	DCLK	
	Pulse Width	Thw	2	4	43	DCLK	
VSYNC	Period Time	Tv	244	260	289	HSYNC	
	Display Period	Tvdisp		240		HSYNC	
	Back Porch	Tvbp	2	12	12	HSYNC	By V_BLANKING setting
	Front Porch	Tvfp	2	8	37	HSYNC	
	Pulse Width	Tvw	2	4	12	HSYNC	

Note: It is necessary to keep Tvbp =12 and Thbp =43 in sync mode. DE mode is unnecessary to keep it.

8. RELIABILITY TEXT

8.1 Standard Specification for Reliability of LCD Module

NO.	TEST ITEM	CONDITIONS
1	HIGH TEMPERATURE STORAGE	TA=+85°C 240H
2	LOW TEMPERATURE STORAGE	TA=-30°C 240H
3	HIGH TEMPERATURE OPERATION	TA=+85°C 240H
4	LOW TEMPERATURE OPERATION	TA=-30°C 240H
5	MOISTURE STORAGE	+60°C, 90%RH, MAX OF 240H
6	THERMAL SHOCK STORAGE	-30°C for 30 minutes → normal temperature for 5 minutes → +85°C for 30 minutes → normal temperature for 5 minutes.as one cycle
7	PACKING VIBRATION	Frequency range:10Hz ~55Hz Amplitude of vibration: 1.5mm Sweep time: 12,min,X,Y,Z 2hours for each direction
8	ESD	Air: ±8kV 150Pf/300 Ω 5 times
		Contact: ±4kV 150Pf/300 Ω 5 times

9. LCD MODULES HANDLING PRECAUTIONS

- The display panel is made of glass. Do not subject it to a mechanical shock by dropping it from a high place, etc.
- If the display panel is damaged and the liquid crystal substance inside it leaks out, do not get any in your mouth. If
- The substance come into contact with your skin or clothes promptly wash it off using soap and water.
- Do not apply excessive force to the display surface or the adjoining areas since this may cause the color tone to vary.
- The polarizer covering the display surface of the LCD module is soft and easily scratched. Handle this polarize carefully.
- To prevent destruction of the elements by static electricity, be careful to maintain an optimum work environment.
 - Be sure to ground the body when handling the LCD module.
 - Tools required for assembly, such as soldering irons, must be properly grounded.
 - To reduce the amount of static electricity generated, do not conduct assembly and other work under dry conditions.
 - The LCD module is coated with a film to protect the display surface. Exercise care when peeling off this protective film since static electricity may be generated.
- Storage precautions
When storing the LCD modules, avoid exposure to direct sunlight or to the light of fluorescent lamps. Keep the modules in bags designed to prevent static electricity charging under low temperature / normal humidity conditions (avoid high temperature / high humidity and low temperatures below 0°C).Whenever possible, the LCD modules should be stored in the same conditions in which they were shipped from our company.

10. OTHERS

- Liquid crystals solidify at low temperature (below the storage temperature range) leading to defective orientation of liquid crystal or the generation of air bubbles (black or white). Air bubbles may also be generated if the module is subjected to a strong shock at a low temperature.
- If the LCD modules have been operating for a long time showing the same display patterns may remain on the screen as ghost images and a slight contrast irregularity may also appear. Abnormal operating status can be resumed to be normal condition by suspending use for some time. It should be noted that this phenomena does not adversely affect performance reliability.
- To minimize the performance degradation of the LCD modules resulting from caused by static electricity, etc. exercise care to avoid holding the following sections when handling the modules:
 - Exposed area of the printed circuit board
 - Terminal electrode sections.