

Data sheet | Item number: 722-838/031-000

THT female header; 0.6 x 1.0 mm solder pin; angled; 100% protected against mismatching; clamping collar; 2.5 mm<sup>2</sup>; Pin spacing 7.5 mm; 8-pole; light gray

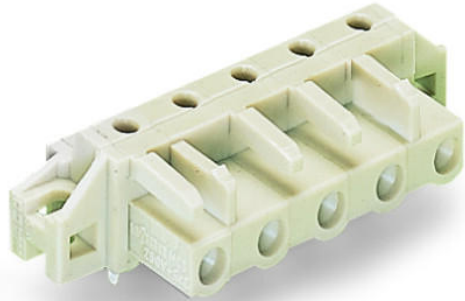

[www.wago.com/722-838/031-000](http://www.wago.com/722-838/031-000)



 Picture differs from the item.

RoHS   
Compliant

[BOMcheck.net](https://www.bomcheck.net)

Color: 

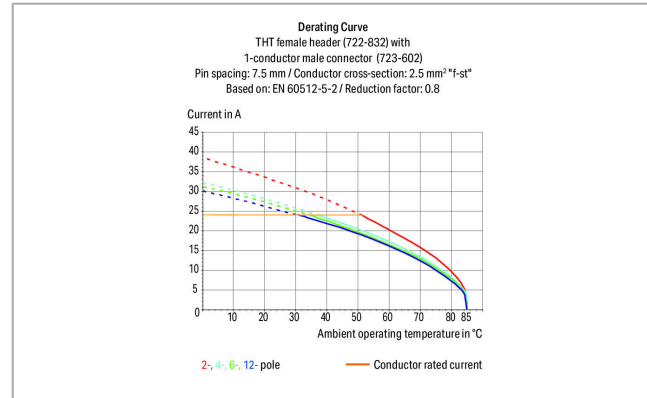

Subject to changes. Please also observe the further product documentation!

WAGO Kontakttechnik GmbH & Co. KG  
Hansastr. 27  
32423 Minden  
Phone: +49571 887-0 | Fax: +49571 887-169  
Email: [info.de@wago.com](mailto:info.de@wago.com) | Web: [www.wago.com](http://www.wago.com)

Do you have any questions about our products?  
We are always happy to take your call at +49 (571) 887-44222.

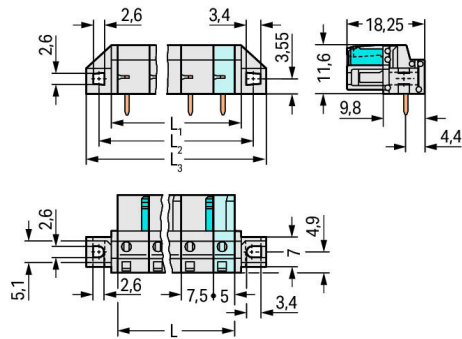

$$L = (\text{pole no.} - 1) \times \text{pin spacing} + 5 \text{ mm}$$

$$L_1 = L + 3 \text{ mm}$$

$$L_2 = L + 8.8 \text{ mm}$$

$$L_3 = L + 14.8 \text{ mm}$$

2-pole female connectors – one latch only

### Item description

- Horizontal or vertical PCB mounting via straight or angled solder pins
- For board-to-board and board-to-wire connections
- Touch-proof PCB outputs
- Easy-to-identify PCB inputs and outputs
- 100 % protected against mismatching
- With coding fingers

### Safety information 1:

The MCS – MULTI CONNECTION SYSTEM includes connectors without breaking capacity in accordance with DIN EN 61984. When used as intended, these connectors must not be connected/disconnected when live or under load. The circuit design should ensure header pins, which can be touched, are not live when unmated.

### Data

#### Electrical data

#### Ratings per IEC/EN

Ratings per	IEC/EN 60664-1
Nominal voltage (III/3)	500 V

Subject to changes. Please also observe the further product documentation!

WAGO Kontakttechnik GmbH & Co. KG  
 Hansastr. 27  
 32423 Minden  
 Phone: +49571 887-0 | Fax: +49571 887-169  
 Email: [info.de@wago.com](mailto:info.de@wago.com) | Web: [www.wago.com](http://www.wago.com)

Do you have any questions about our products?  
 We are always happy to take your call at +49 (571) 887-44222.



Rated surge voltage (III/3)	6 kV
Rated voltage (III/2)	630 V
Rated surge voltage (III/2)	6 kV
Nominal voltage (II/2)	1000 V
Rated surge voltage (II/2)	6 kV
Rated current	12 A
Legend (ratings)	(III / 2) $\hat{=}$ Overvoltage category III / Pollution degree 2

### Ratings per UL

Approvals per	UL 1059
Rated voltage UL (Use Group B)	300 V
Rated current UL (Use Group B)	15 A
Rated voltage UL (Use Group D)	300 V
Rated current UL (Use Group D)	10 A

### Ratings per UL

Rated voltage UL 1977	600 V
Rated current UL 1977	15 A

### Ratings per CSA

Approvals per	CSA
Rated voltage CSA (Use Group B)	300 V
Rated current CSA (Use Group B)	15 A
Rated voltage CSA (Use Group D)	300 V
Rated current CSA (Use Group D)	10 A

### Connection data

Pole No.	8
Total number of potentials	8
Number of connection types	1
Number of levels	1

### Physical data

Pin spacing	7.5 mm / 0.295 inch
Width	72.3 mm / 2.846 inch
Height	16.6 mm / 0.654 inch

Subject to changes. Please also observe the further product documentation!



Height from the surface	11.6 mm / 0.457 inch
Depth	18.25 mm / 0.719 inch
Solder pin length	5 mm
Solder pin dimensions	0.6 x 1 mm
Drilled hole diameter with tolerance	1.3 <sup>(+0.1)</sup> mm

### Mechanical data

Mounting type	Mounting flange
Mounting type	Feed-through mounting Panel mounting

### Plug-in connection

Contact type (pluggable connector)	Female connector/socket
Connector (connection type)	for PCB
Mismating protection	Yes
Mating direction to the PCB	0°

### PCB contact

PCB Contact	THT
Solder pin arrangement	over the entire female connector (in-line)
Number of solder pins per potential	1

### Material data

Color	light gray
Material group	I
Insulation material	Polyamide (PA66)
Flammability class per UL94	V0
Contact material	Copper alloy
Contact plating	tin-plated
Weight	9.4 g

### Environmental requirements

Limit temperature range	-60 ... +85 °C
-------------------------	----------------

### Commercial data

Packaging type	BOX
----------------	-----

Subject to changes. Please also observe the further product documentation!



WAGO Kontakttechnik GmbH & Co. KG  
 Hansastr. 27  
 32423 Minden  
 Phone: +49571 887-0 | Fax: +49571 887-169  
 Email: [info.de@wago.com](mailto:info.de@wago.com) | Web: [www.wago.com](http://www.wago.com)

Do you have any questions about our products?  
 We are always happy to take your call at +49 (571) 887-44222.



Country of origin	DE
GTIN	4055143759380
Customs tariff number	85366990990

## Approvals / Certificates

### Ship Approvals

Logo	Approval	Additional Approval Text	Certificate name
	<b>ABS</b> American Bureau of Shipping	-	19- HG1869876- PDA
	<b>BV</b> Bureau Veritas S.A.	IEC 60998	11915/DO BV
	<b>DNV GL</b> Det Norske Veritas, Germanischer Lloyd	-	TAE000016Z

### UL-Approvals

Logo	Approval	Additional Approval Text	Certificate name
	<b>UR</b> Underwriters Laboratories Inc.	UL 1059	E45172
	<b>UR</b> Underwriters Laboratories Inc.	UL 1977	20150318- E45171

### Counterpart



Item no.723-608

1-conductor male connector; 100% protected against mismatching; 2.5 mm<sup>2</sup>; Pin spacing 7.5 mm; 8-pole; 2,50 mm<sup>2</sup>; light gray[www.wago.com/723-608](http://www.wago.com/723-608)

## Downloads

### Documentation

Subject to changes. Please also observe the further product documentation!

WAGO Kontakttechnik GmbH &amp; Co. KG

Hansastr. 27

32423 Minden

Phone: +49571 887-0 | Fax: +49571 887-169

Email: [info.de@wago.com](mailto:info.de@wago.com) | Web: [www.wago.com](http://www.wago.com)

Do you have any questions about our products?

We are always happy to take your call at +49 (571) 887-44222.



#### Additional Information

Technical explanations

3. 4. 2019

pdf  
2.0 MB

[Download](#)

#### CAD/CAE-Data

##### CAD data

2D/3D Models 722-838/031-000

[URL](#)

[Download](#)

##### PCB Design

Symbol and Footprint 722-838/031-000

[URL](#)

[Download](#)

CAX data for your PCB design, consisting of "schematic symbols and PCB footprints", allow easy integration of the WAGO component into your development environment.

##### Supported formats:

- Accel EDA 14 & 15
- Altium 6 to current version
- Cadence Allegro
- DesignSpark
- Eagle Libraries
- KiCad
- Mentor Graphics BoardStation
- Mentor Graphics Design Architect
- Mentor Graphics Design Expedition 99 and 2000
- OrCAD 9.X PCB and Capture
- PADS PowerPCB 3, 3.5, 4.X, and 5.X
- PADS PowerPCB and PowerLogic 3.0
- PCAD 2000, 2001, 2002, 2004, and 2006
- Pulsonix 8.5 or newer
- STL
- 3D STEP
- TARGET 3001!
- View Logic ViewDraw
- Quadcept
- Zuken CadStar 3 and 4
- Zuken CR-5000 and CR-8000

PCB Component Libraries (EDA), PCB CAD Library Ultra Librarian

Subject to changes. Please also observe the further product documentation!

WAGO Kontakttechnik GmbH & Co. KG

Hansastr. 27

32423 Minden

Phone: +49571 887-0 | Fax: +49571 887-169

Email: [info.de@wago.com](mailto:info.de@wago.com) | Web: [www.wago.com](http://www.wago.com)

Do you have any questions about our products?

We are always happy to take your call at +49 (571) 887-44222.



#### CAE data

ZUKEN Portal 722-838/031-000	URL	Download
------------------------------	-----	----------

---

#### Environmental Product Compliance

##### Compliance Search

Environmental Product Compliance 722-838/031-000	URL	Download
--	-----	----------

THT female header; 0.6 x 1.0 mm solder pin; angled; 100% protected against mismatching; clamping collar; 2.5 mm<sup>2</sup>; Pin spacing 7.5 mm; 8-pole; light gray

---

#### Installation Notes

#### Product family

<i>MCS</i> MIDI

[Show all products from the family](#)

Subject to changes. Please also observe the further product documentation!

---

WAGO Kontakttechnik GmbH & Co. KG  
Hansastr. 27  
32423 Minden  
Phone: +49571 887-0 | Fax: +49571 887-169  
Email: [info.de@wago.com](mailto:info.de@wago.com) | Web: [www.wago.com](http://www.wago.com)

Do you have any questions about our products?  
We are always happy to take your call at +49 (571) 887-44222.