

## Data Sheet | Item Number: 2222-1302

2-conductor/1-pin carrier terminal block; with push-button; 2.5 mm<sup>2</sup>; for DIN-rail 35 x 15 and 35 x 7.5; Push-in CAGE CLAMP®; 2,50 mm<sup>2</sup>; orange

<https://www.wago.com/2222-1302>

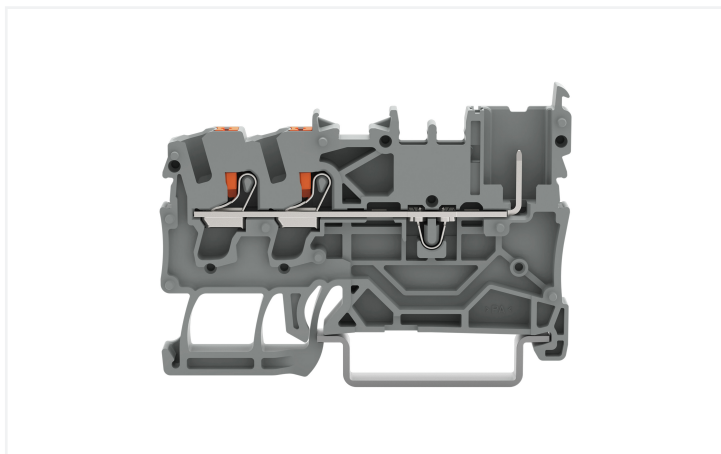

Color: ■ orange

Similar to illustration

### Electrical data

Ratings per	IEC/EN 60947-7-1		
Overvoltage category	III	III	II
Pollution degree	3	2	2
Nominal voltage	690 V	-	-
Rated surge voltage	6 kV	-	-
Rated current	24 A	-	-
Current at conductor cross-section (max.) mm <sup>2</sup>	32 A	-	-

Approvals per	UL 1059		
Use group	B	C	D
Rated voltage	600 V	600 V	-
Rated current	20 A	20 A	-

Approvals per	CSA 22.2 No 158		
Use group	B	C	D
Rated voltage	-	600 V	-
Rated current	-	20 A	-

Power loss	
Power loss, per pole (potential)	0.7661 W
Rated current I <sub>N</sub> for specified power loss	24 A
Resistance value for specified, current-dependent power loss	0.00133 Ω

### Connection data

Connection points	2
Female plug slots	1
Total number of potentials	1
Number of levels	1

Connection 1	
Connection technology	Push-in CAGE CLAMP®
Actuation type	Push-button
Connectable conductor materials	Copper
Nominal cross-section	2.5 mm <sup>2</sup>
Solid conductor	0.25 ... 4 mm <sup>2</sup> / 22 ... 12 AWG
Solid conductor; push-in termination	0.75 ... 4 mm <sup>2</sup> / 18 ... 12 AWG
Fine-stranded conductor	0.25 ... 4 mm <sup>2</sup> / 22 ... 12 AWG
Fine-stranded conductor; with insulated ferrule	0.25 ... 2.5 mm <sup>2</sup> / 22 ... 14 AWG
Fine-stranded conductor; with ferrule; push-in termination	1 ... 2.5 mm <sup>2</sup> / 18 ... 14 AWG
Note (conductor cross-section)	Depending on the conductor characteristic, a conductor with a smaller cross-section can also be inserted via push-in termination.
Strip length	10 ... 12 mm / 0.39 ... 0.47 inches
Wiring direction	Front-entry wiring

### Physical data

Width	5.2 mm / 0.205 inches
Height	59.2 mm / 2.331 inches
Depth from upper-edge of DIN-rail	36.4 mm / 1.433 inches

### Mechanical data

Mounting type	DIN-35 rail
Marking level	Center/side marking

### Material data

Note (material data)	<a href="#">Information on material specifications can be found here</a>
Color	orange
Material group	I
Insulation material	Polyamide (PA66)
Flammability class per UL94	V0
Fire load	0.16 MJ
Weight	6.7 g

### Environmental requirements

Processing temperature	-35 ... +85 °C
Continuous operating temperature	-60 ... +105 °C

### Commercial data

ETIM 8.0	EC000897
ETIM 7.0	EC000897
PU (SPU)	100 pcs
Country of origin	PL
GTIN	4066966203875
Customs tariff number	85369010000

### Environmental Product Compliance

RoHS Compliance Status	Compliant, No Exemption
------------------------	-------------------------

### Approvals / Certificates

#### General approvals



Approval	Standard	Certificate Name
CCA DEKRA Certification B.V.	EN 60947	NTR CCA NL-7935
CSA DEKRA Certification B.V.	C22.2	80105020
KEMA/KEUR DEKRA Certification B.V.	EN 60947	71-123713

### Downloads

## Environmental Product Compliance

### Compliance Search

Environmental Product  
Compliance 2222-1302



## Documentation

### Additional Information

Technical Section

pdf  
2142.18 KB



## 1 Compatible Products

### 1.1 System counterpart

#### 1.1.1 Female connector/socket



##### Item No.: [2022-101](#)

1-conductor female connector; Push-in CAGE CLAMP®; 4 mm²; Pin spacing 5.2 mm; 1-pole; 4,00 mm²; gray

### 1.2 Required Accessories

#### 1.2.1 End plate

##### 1.2.1.1 End plate



##### Item No.: [2022-1391](#)

End and intermediate plate; 1 mm thick; gray



##### Item No.: [2022-1392](#)

End and intermediate plate; 1 mm thick; orange

### 1.3 Optional Accessories

#### 1.3.1 Coding

##### 1.3.1.1 Coding



##### Item No.: [2022-100](#)

Carrier with 6 coding pins; for coding of female plugs; orange

#### 1.3.2 DIN-rail

1.3.2.1 Mounting accessories



**Item No.: 210-196**  
Aluminum carrier rail; 35 x 8.2 mm; 1.6 mm thick; 2 m long; unslotted; similar to EN 60715; silver-colored



**Item No.: 210-198**  
Copper carrier rail; 35 x 15 mm; 2.3 mm thick; 2 m long; unslotted; according to EN 60715; copper-colored



**Item No.: 210-197**  
Steel carrier rail; 35 x 15 mm; 1.5 mm thick; 2 m long; slotted; similar to EN 60715; silver-colored



**Item No.: 210-114**  
Steel carrier rail; 35 x 15 mm; 1.5 mm thick; 2 m long; unslotted; similar to EN 60715; silver-colored



**Item No.: 210-118**  
Steel carrier rail; 35 x 15 mm; 2.3 mm thick; 2 m long; unslotted; according to EN 60715; silver-colored



**Item No.: 210-115**  
Steel carrier rail; 35 x 7.5 mm; 1 mm thick; 2 m long; slotted; according to EN 60715; "Hole width 18 mm; silver-colored



**Item No.: 210-112**  
Steel carrier rail; 35 x 7.5 mm; 1 mm thick; 2 m long; slotted; according to EN 60715; "Hole width 25 mm; silver-colored



**Item No.: 210-113**  
Steel carrier rail; 35 x 7.5 mm; 1 mm thick; 2 m long; unslotted; according to EN 60715; silver-colored

1.3.3 Ferrule

1.3.3.1 Ferrule



**Item No.: 216-241**  
Ferrule; Sleeve for 0.5 mm<sup>2</sup> / 20 AWG; insulated; electro-tin plated; electrolytic copper; gastight crimped; acc. to DIN 46228, Part 4/09.90; white



**Item No.: 216-242**  
Ferrule; Sleeve for 0.75 mm<sup>2</sup> / 18 AWG; insulated; electro-tin plated; electrolytic copper; gastight crimped; acc. to DIN 46228, Part 4/09.90; gray



**Item No.: 216-262**  
Ferrule; Sleeve for 0.75 mm<sup>2</sup> / 18 AWG; insulated; electro-tin plated; electrolytic copper; gastight crimped; acc. to DIN 46228, Part 4/09.90; gray



**Item No.: 216-243**  
Ferrule; Sleeve for 1 mm<sup>2</sup> / AWG 18; insulated; electro-tin plated; electrolytic copper; gastight crimped; acc. to DIN 46228, Part 4/09.90; red



**Item No.: 216-263**  
Ferrule; Sleeve for 1 mm<sup>2</sup> / AWG 18; insulated; electro-tin plated; electrolytic copper; gastight crimped; acc. to DIN 46228, Part 4/09.90; red



**Item No.: 216-244**  
Ferrule; Sleeve for 1.5 mm<sup>2</sup> / AWG 16; insulated; electro-tin plated; electrolytic copper; gastight crimped; acc. to DIN 46228, Part 4/09.90; black



**Item No.: 216-264**  
Ferrule; Sleeve for 1.5 mm<sup>2</sup> / AWG 16; insulated; electro-tin plated; electrolytic copper; gastight crimped; acc. to DIN 46228, Part 4/09.90; black



**Item No.: 216-284**  
Ferrule; Sleeve for 1.5 mm<sup>2</sup> / AWG 16; insulated; electro-tin plated; electrolytic copper; gastight crimped; acc. to DIN 46228, Part 4/09.90; black



**Item No.: 216-246**  
Ferrule; Sleeve for 2.5 mm<sup>2</sup> / AWG 14; insulated; electro-tin plated; electrolytic copper; gastight crimped; acc. to DIN 46228, Part 4/09.90; blue



**Item No.: 216-266**  
Ferrule; Sleeve for 2.5 mm<sup>2</sup> / AWG 14; insulated; electro-tin plated; electrolytic copper; gastight crimped; acc. to DIN 46228, Part 4/09.90; blue



**Item No.: 216-286**  
Ferrule; Sleeve for 2.5 mm<sup>2</sup> / AWG 14; insulated; electro-tin plated; electrolytic copper; gastight crimped; acc. to DIN 46228, Part 4/09.90; blue

1.3.4 Insulation stop

1.3.4.1 Insulation stop



**Item No.: 2002-171**  
Insulation stop; 0.25 - 0.5 mm<sup>2</sup>; 5 pieces/strip; light gray



**Item No.: 2002-172**  
Insulation stop; 0.75 - 1 mm<sup>2</sup>; 5 pieces/strip; dark gray

1.3.5 Jumper

1.3.5.1 Jumper



**Item No.: 2002-400**  
Continuous jumper; 2-way; insulated; light gray



**Item No.: 2002-423/000-006**  
Continuous jumper; from 1 to 3; insulated; blue



**Item No.: 2002-423**  
Continuous jumper; from 1 to 3; insulated; light gray



**Item No.: 2002-423/000-005**  
Continuous jumper; from 1 to 3; insulated; red



**Item No.: 2002-424/000-006**  
Continuous jumper; from 1 to 4; insulated; blue



**Item No.: 2002-424**  
Continuous jumper; from 1 to 4; insulated; light gray





**Item No.: 2002-424/000-005**  
Continuous jumper; from 1 to 4; insulated; red



**Item No.: 2002-406/020-000**  
Delta jumper; insulated; light gray

1.3.5.1 Jumper

 <b>Item No.:</b> <a href="#">2002-410/000-006</a> Jumper; 10-way; insulated; blue	 <b>Item No.:</b> <a href="#">2002-410</a> Jumper; 10-way; insulated; light gray	 <b>Item No.:</b> <a href="#">2002-410/000-005</a> Jumper; 10-way; insulated; red	 <b>Item No.:</b> <a href="#">2002-402/000-006</a> Jumper; 2-way; insulated; blue
 <b>Item No.:</b> <a href="#">2002-402</a> Jumper; 2-way; insulated; light gray	 <b>Item No.:</b> <a href="#">2002-402/000-005</a> Jumper; 2-way; insulated; red	 <b>Item No.:</b> <a href="#">2002-403/000-006</a> Jumper; 3-way; insulated; blue	 <b>Item No.:</b> <a href="#">2002-403</a> Jumper; 3-way; insulated; light gray
 <b>Item No.:</b> <a href="#">2002-403/000-005</a> Jumper; 3-way; insulated; red	 <b>Item No.:</b> <a href="#">2002-404/000-006</a> Jumper; 4-way; insulated; blue	 <b>Item No.:</b> <a href="#">2002-404</a> Jumper; 4-way; insulated; light gray	 <b>Item No.:</b> <a href="#">2002-404/000-005</a> Jumper; 4-way; insulated; red
 <b>Item No.:</b> <a href="#">2002-405/000-006</a> Jumper; 5-way; insulated; blue	 <b>Item No.:</b> <a href="#">2002-405</a> Jumper; 5-way; insulated; light gray	 <b>Item No.:</b> <a href="#">2002-405/000-005</a> Jumper; 5-way; insulated; red	 <b>Item No.:</b> <a href="#">2002-406/000-006</a> Jumper; 6-way; insulated; blue
 <b>Item No.:</b> <a href="#">2002-406</a> Jumper; 6-way; insulated; light gray	 <b>Item No.:</b> <a href="#">2002-406/000-005</a> Jumper; 6-way; insulated; red	 <b>Item No.:</b> <a href="#">2002-407/000-006</a> Jumper; 7-way; insulated; blue	 <b>Item No.:</b> <a href="#">2002-407</a> Jumper; 7-way; insulated; light gray
 <b>Item No.:</b> <a href="#">2002-407/000-005</a> Jumper; 7-way; insulated; red	 <b>Item No.:</b> <a href="#">2002-408/000-006</a> Jumper; 8-way; insulated; blue	 <b>Item No.:</b> <a href="#">2002-408</a> Jumper; 8-way; insulated; light gray	 <b>Item No.:</b> <a href="#">2002-408/000-005</a> Jumper; 8-way; insulated; red
 <b>Item No.:</b> <a href="#">2002-409/000-006</a> Jumper; 9-way; insulated; blue	 <b>Item No.:</b> <a href="#">2002-409</a> Jumper; 9-way; insulated; light gray	 <b>Item No.:</b> <a href="#">2002-409/000-005</a> Jumper; 9-way; insulated; red	 <b>Item No.:</b> <a href="#">2002-440</a> Jumper; from 1 to 10; insulated; light gray
 <b>Item No.:</b> <a href="#">2002-433</a> Jumper; from 1 to 3; insulated; light gray	 <b>Item No.:</b> <a href="#">2002-434</a> Jumper; from 1 to 4; insulated; light gray	 <b>Item No.:</b> <a href="#">2002-435</a> Jumper; from 1 to 5; insulated; light gray	 <b>Item No.:</b> <a href="#">2002-436</a> Jumper; from 1 to 6; insulated; light gray
 <b>Item No.:</b> <a href="#">2002-437</a> Jumper; from 1 to 7; insulated; light gray	 <b>Item No.:</b> <a href="#">2002-438</a> Jumper; from 1 to 8; insulated; light gray	 <b>Item No.:</b> <a href="#">2002-439</a> Jumper; from 1 to 9; insulated; light gray	 <b>Item No.:</b> <a href="#">2002-480</a> Staggered jumper; 10-way; insulated; light gray
 <b>Item No.:</b> <a href="#">2002-481</a> Staggered jumper; 11-way; insulated; light gray	 <b>Item No.:</b> <a href="#">2002-482</a> Staggered jumper; 12-way; insulated; light gray	 <b>Item No.:</b> <a href="#">2002-473/011-000</a> Staggered jumper; 2-way; from 1 to 3; insulated; light gray	 <b>Item No.:</b> <a href="#">2002-472</a> Staggered jumper; 2-way; insulated; light gray
 <b>Item No.:</b> <a href="#">2002-473</a> Staggered jumper; 3-way; insulated; light gray	 <b>Item No.:</b> <a href="#">2002-475/011-000</a> Staggered jumper; 3-way; insulated; light gray	 <b>Item No.:</b> <a href="#">2002-474</a> Staggered jumper; 4-way; insulated; light gray	 <b>Item No.:</b> <a href="#">2002-475</a> Staggered jumper; 5-way; insulated; light gray
 <b>Item No.:</b> <a href="#">2002-476</a> Staggered jumper; 6-way; insulated; light gray	 <b>Item No.:</b> <a href="#">2002-477</a> Staggered jumper; 7-way; insulated; light gray	 <b>Item No.:</b> <a href="#">2002-478</a> Staggered jumper; 8-way; insulated; light gray	 <b>Item No.:</b> <a href="#">2002-479</a> Staggered jumper; 9-way; insulated; light gray
 <b>Item No.:</b> <a href="#">2002-477/011-000</a> Staggered jumper; insulated; light gray	 <b>Item No.:</b> <a href="#">2002-479/011-000</a> Staggered jumper; insulated; light gray	 <b>Item No.:</b> <a href="#">2002-481/011-000</a> Staggered jumper; insulated; light gray	 <b>Item No.:</b> <a href="#">2002-405/011-000</a> Star point jumper; 3-way; insulated; light gray
 <b>Item No.:</b> <a href="#">210-103</a> Wire commoning chain; insulated; black	 <b>Item No.:</b> <a href="#">210-123</a> Wire commoning chain; insulated; blue		

1.3.6 Marking

1.3.6.1 Group marker carrier



**Item No.: 2009-191**  
Group marker carrier; gray

**Item No.: 2009-192**  
Group marker carrier; gray

**Item No.: 2009-193**  
Group marker carrier; gray

1.3.6.2 Marker



**Item No.: 2009-145**  
Mini-WSB Inline; for Smart Printer; 1700 pieces on roll; stretchable 5 - 5.2 mm; plain; snap-on type; white

**Item No.: 248-501**  
Mini-WSB marking card; as card; not stretchable; plain; snap-on type; white

**Item No.: 793-5501**  
WMB marking card; as card; for terminal block width 5 - 17.5 mm; stretchable 5 - 5.2 mm; plain; snap-on type; white

**Item No.: 2009-115**  
WMB-Inline; for Smart Printer; 1500 pieces on roll; stretchable 5 - 5.2 mm; plain; snap-on type; white

1.3.6.3 Marker carrier



**Item No.: 2002-161**  
Adaptor; gray

**Item No.: 2009-198**  
Adaptor; gray

1.3.6.4 Marking strip



**Item No.: 2009-110**  
Marking strips; for Smart Printer; on reel; not stretchable; plain; snap-on type; white

1.3.7 Push-in type wire jumper

1.3.7.1 Jumper



**Item No.: 2009-414**  
Push-in type wire jumper; 1.5 mm<sup>2</sup>; insulated; 110 mm long; black

**Item No.: 2009-414/000-005**  
Push-in type wire jumper; 1.5 mm<sup>2</sup>; insulated; 110 mm long; black

**Item No.: 2009-416**  
Push-in type wire jumper; 1.5 mm<sup>2</sup>; insulated; 250 mm long; black

**Item No.: 2009-414/000-006**  
Push-in type wire jumper; insulated; 110 mm long; black



**Item No.: 2009-412**  
Push-in type wire jumper; insulated; 60 mm long; black

1.3.8 Test and measurement

1.3.8.1 Testing accessories



**Item No.: 2002-560**  
Modular TOPJOB®S connector; modular; for jumper contact slot; 10-pole; 2,50 mm<sup>2</sup>; gray

**Item No.: 2002-511**  
Modular TOPJOB®S connector; modular; for jumper contact slot; 1-pole; 2,50 mm<sup>2</sup>; gray

**Item No.: 2002-552**  
Modular TOPJOB®S connector; modular; for jumper contact slot; 2-pole; 2,50 mm<sup>2</sup>; gray

**Item No.: 2002-553**  
Modular TOPJOB®S connector; modular; for jumper contact slot; 3-pole; 2,50 mm<sup>2</sup>; gray



**Item No.: 2002-554**  
Modular TOPJOB®S connector; modular; for jumper contact slot; 4-pole; 2,50 mm<sup>2</sup>; gray

**Item No.: 2002-555**  
Modular TOPJOB®S connector; modular; for jumper contact slot; 5-pole; 2,50 mm<sup>2</sup>; gray

**Item No.: 2002-556**  
Modular TOPJOB®S connector; modular; for jumper contact slot; 6-pole; 2,50 mm<sup>2</sup>; gray

**Item No.: 2002-557**  
Modular TOPJOB®S connector; modular; for jumper contact slot; 7-pole; 2,50 mm<sup>2</sup>; gray

### 1.3.8.1 Testing accessories



**Item No.: 2002-558**

Modular TOPJOB®S connector; modular; for jumper contact slot; 8-pole; 2,50 mm<sup>2</sup>; gray



**Item No.: 2002-559**

Modular TOPJOB®S connector; modular; for jumper contact slot; 9-pole; 2,50 mm<sup>2</sup>; gray



**Item No.: 2002-549**

Spacer module; modular; e.g., for bridging commoned terminal blocks; gray



**Item No.: 2009-174**

Test plug adapter; for 4 mm Ø test plugs; for testing TOPJOB®S rail-mounted terminal blocks; gray



**Item No.: 2009-182**

Testing tap; for max. 2.5 mm<sup>2</sup>; tool-free connection for individual test wires 0.08 - 2.5 mm; gray



**Item No.: 859-500**

WAGO Test pin; 1 mm Ø; 30 V AC / 60 V DC; CAT0; 1 A; 10 mm uninsulated; Test lead for soldering up to 0,5mm<sup>2</sup>

### 1.3.9 Tool

#### 1.3.9.1 Operating tool



**Item No.: 210-720**

Operating tool; Blade: 3.5 x 0.5 mm; with a partially insulated shaft; multicoloured

### Installation Notes

#### Installation



Snap individual carrier terminal blocks onto the DIN-rail and slide together.

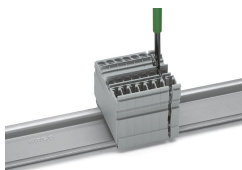

Open the assembly by laterally sliding a block via operating tool (3.5 x 0.5 mm blade).

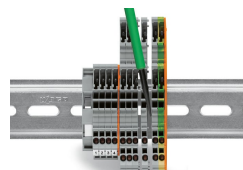

Separate terminal block assembly and slide individual terminal blocks laterally using an operating tool.

### Conductor termination

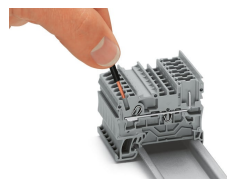

Push-in CAGE CLAMP® enables solid conductors to be connected by simply pushing them into the unit.

### Commoning

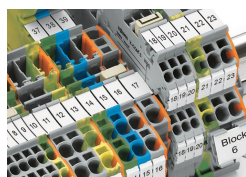

Commoning X-COM®S-SYSTEM Terminal Blocks using jumpers for TOPJOB® S Terminal Blocks. An end plate provides connection to TOPJOB® S Terminal Blocks. 2020 and 2022 Series Terminal Blocks are combinable. Jumper slots are on the same level for both series.

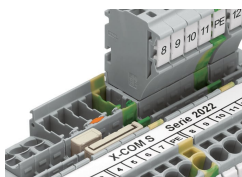

Pairing push-in comb style jumpers.

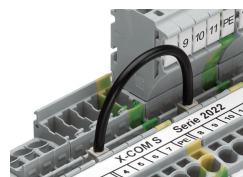

Commoning with push-in type wire jumper.

Testing

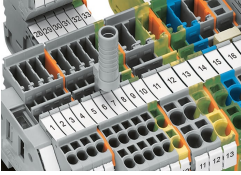

Test plug adapter (2009-174) for 4 mm test plugs or banana plugs – also suitable for X-COM®S-SYSTEM-MINI Terminal Blocks.

Coding

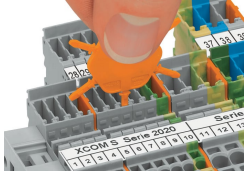

Insert coding pin into the corresponding slot and twist it off.



Coding a female plug: remove coding finger using a suitable tool.

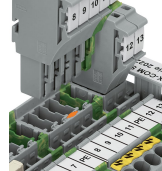

Insert a coding pin (2022-100) into the corresponding location of the carrier terminal block.

Marking

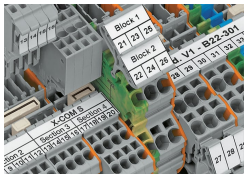

Clear marking via large marking area

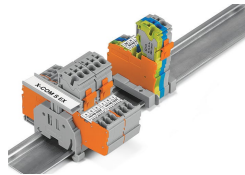

Group marking with height-adjustable group marker carrier (2009-163)

Security

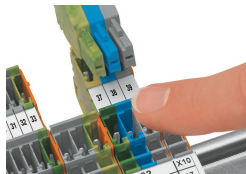

Carrier terminal blocks and female plugs are touch-proof.