

## Data sheet | Item number: 2020-5377/102-000

3-conductor sensor/actuator terminal block; for PNP-(high-side) switching actuators; with ground contact; 1 mm<sup>2</sup>; Push-in CAGE CLAMP®; 1,00 mm<sup>2</sup>; orange

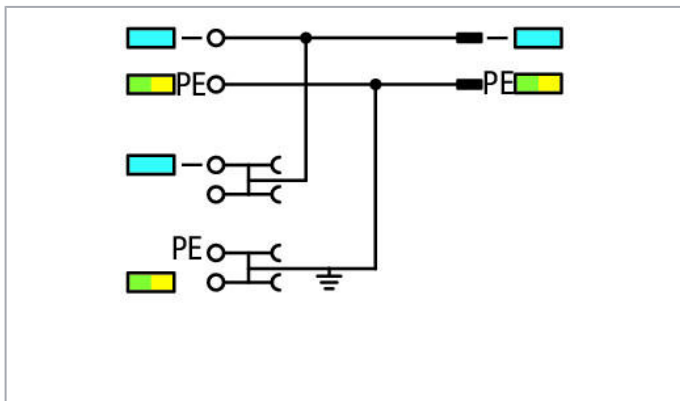

[www.wago.com/2020-5377/102-000](http://www.wago.com/2020-5377/102-000)

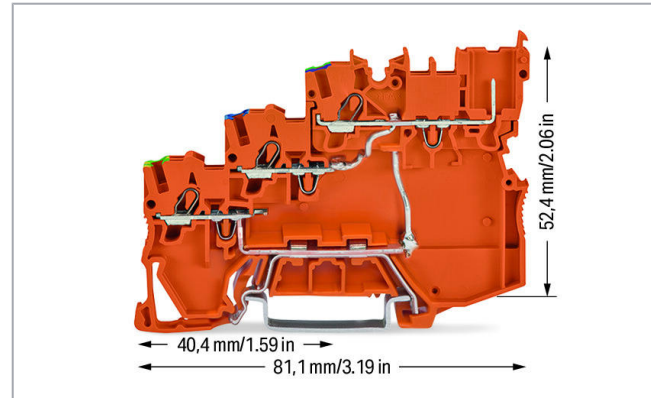
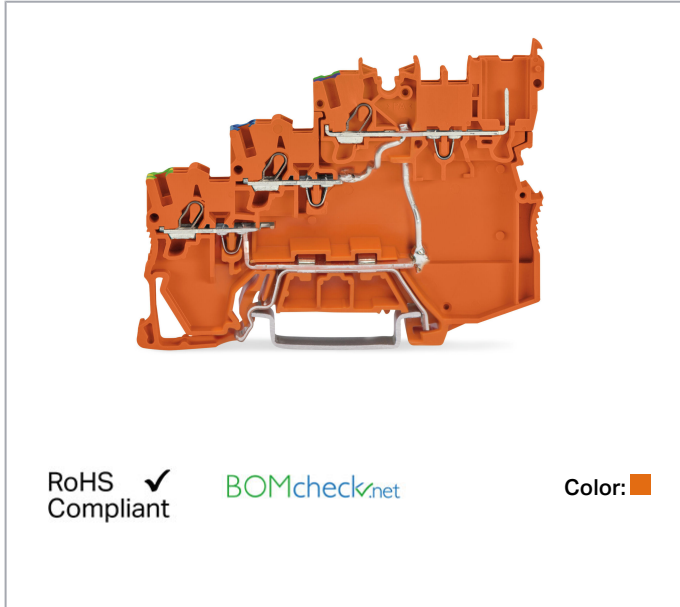

### Item description

3.5 mm spacing per signal (2 x 3.5 mm = 7 mm)

The double spacing per pole of this terminal block series maximizes connectivity. For example, ten sensors may be connected using only five sensor terminal blocks plus a power supply terminal block.

### Data

#### Electrical data

Subject to changes. Please also observe the further product documentation!

WAGO Kontakttechnik GmbH & Co. KG  
Hansastr. 27  
32423 Minden  
Phone: +49571 887-0 | Fax: +49571 887-169  
Email: [info.de@wago.com](mailto:info.de@wago.com) | Web: [www.wago.com](http://www.wago.com)

Do you have any questions about our products?  
We are always happy to take your call at +49 (571) 887-44222.



### Ratings per IEC/EN

Ratings per	IEC/EN 60947-7-1
Nominal voltage (III/3)	250 V
Rated current	13.5 A
Legend (ratings)	(III / 3) ≙ Overvoltage category III / Pollution degree 3

### Ratings per UL

Approvals per	UL 1059
Rated voltage UL (Use Group B)	300 V
Rated current UL (Use Group B)	15 A
Rated voltage UL (Use Group D)	300 V
Rated current UL (Use Group D)	15 A

### Ratings per CSA

Approvals per	C22.2 No 158
Rated voltage CSA (Use Group C)	300 V
Rated current CSA (Use Group C)	10 A

### Connection data

Connection technology	Push-in CAGE CLAMP®
Actuation type	Push-in Open Tool Slot
Connectable conductor materials	Copper
Nominal cross-section	1 mm <sup>2</sup>
Solid conductor	0.14 ... 1.5 mm <sup>2</sup> / 24 ... 16 AWG
Solid conductor; push-in termination	0.5 ... 1.5 mm <sup>2</sup> / 20 ... 16 AWG
Fine-stranded conductor	0.14 ... 1.5 mm <sup>2</sup> / 24 ... 16 AWG
Fine-stranded conductor; with insulated ferrule	0.5 ... 0.75 mm <sup>2</sup> / 20 ... 18 AWG
Fine-stranded conductor; with ferrule; push-in termination	0.5 ... 0.75 mm <sup>2</sup> / 20 ... 18 AWG
Note (conductor cross-section)	Depending on the conductor characteristic, a conductor with a smaller cross-section can also be inserted via push-in termination.
Strip length	9 ... 11 mm / 0.35 ... 0.43 inch
Total number of connection points	6
Total number of potentials	4
Number of levels	3
Wiring type	Front-entry wiring

Subject to changes. Please also observe the further product documentation!

WAGO Kontakttechnik GmbH & Co. KG  
 Hansastr. 27  
 32423 Minden  
 Phone: +49571 887-0 | Fax: +49571 887-169  
 Email: [info.de@wago.com](mailto:info.de@wago.com) | Web: [www.wago.com](http://www.wago.com)

Do you have any questions about our products?  
 We are always happy to take your call at +49 (571) 887-44222.

Number of jumper slots	3
------------------------	---

### Physical data

Width	7 mm / 0.276 inch
Height	81.1 mm / 3.193 inch

### Mechanical data

Design	horizontal type
Mounting type	DIN-35 rail
Marking level	Center/side marking

### Material data



Color	orange
Insulation material	Polyamide (PA66)
Weight	18.4 g

### Commercial data

Packaging type	BOX
Country of origin	DE
GTIN	4055143523844
Customs tariff number	85369010000

### Approvals / Certificates

#### Country specific Approvals

Logo	Approval	Additional Approval Text	Certificate name
	CCA DEKRA Certification B.V.	EN 60947	NTR NL 7617
	CSA DEKRA Certification B.V.	C22.2 No. 158	2516073
	KEMA/KEUR DEKRA Certification B.V.	EN 60947	71- 100670

Subject to changes. Please also observe the further product documentation!

WAGO Kontakttechnik GmbH & Co. KG  
 Hansastr. 27  
 32423 Minden  
 Phone: +49571 887-0 | Fax: +49571 887-169  
 Email: [info.de@wago.com](mailto:info.de@wago.com) | Web: [www.wago.com](http://www.wago.com)

Do you have any questions about our products?  
 We are always happy to take your call at +49 (571) 887-44222.

## UL-Approvals

Logo	Approval	Additional Approval Text	Certificate name
	UL UL International Germany GmbH	UL 1059	20171023- E45172

## Required accessories

## End plate



	Item no.: 2020-5391 End and intermediate plate; 1 mm thick; for 3-conductor terminal blocks; gray	<a href="http://www.wago.com/2020-5391">www.wago.com/2020-5391</a>
--	--	--

## Compatible products





## Coding

	Item no.: 2020-100 Carrier with 6 coding pins; for coding of female plugs; for carrier terminal blocks; orange	<a href="http://www.wago.com/2020-100">www.wago.com/2020-100</a>
--	---	--















## Push-In type wire jumper

	Item no.: 209-402 Push-in type wire jumper; 0.75 mm <sup>2</sup> ; insulated; 60 mm long; gray	<a href="http://www.wago.com/209-402">www.wago.com/209-402</a>
	Item no.: 209-404 Push-in type wire jumper; 0.75 mm <sup>2</sup> ; insulated; 110 mm long; gray	<a href="http://www.wago.com/209-404">www.wago.com/209-404</a>
	Item no.: 209-406 Push-in type wire jumper; 0.75 mm <sup>2</sup> ; insulated; 250 mm long; gray	<a href="http://www.wago.com/209-406">www.wago.com/209-406</a>

## Marking accessories

	Item no.: 2000-121 Adaptor; gray	<a href="http://www.wago.com/2000-121">www.wago.com/2000-121</a>
	Item no.: 209-110 Marking strips; for Smart Printer; on reel; not stretchable; plain; snap-on type; white	<a href="http://www.wago.com/209-110">www.wago.com/209-110</a>
	Item no.: 209-113 WMB-Inline; for Smart Printer; 2300 pieces on roll; plain; snap-on type; white	<a href="http://www.wago.com/209-113">www.wago.com/209-113</a>
	Item no.: 209-113/000-002 WMB-Inline; for Smart Printer; 2300 pieces on roll; plain; snap-on type; yellow	<a href="http://www.wago.com/209-113/000-002">www.wago.com/209-113/000-002</a>
	Item no.: 209-113/000-005 WMB-Inline; for Smart Printer; 2300 pieces on roll; plain; snap-on type; red	<a href="http://www.wago.com/209-113/000-005">www.wago.com/209-113/000-005</a>

Subject to changes. Please also observe the further product documentation!

	<b>Item no.: 2009-113/000-006</b> WMB-Inline; for Smart Printer; 2300 pieces on roll; plain; snap-on type; blue	<a href="http://www.wago.com/2009-113/000-006">www.wago.com/2009-113/000-006</a>
	<b>Item no.: 2009-113/000-007</b> WMB-Inline; for Smart Printer; 2300 pieces on roll; plain; snap-on type; gray	<a href="http://www.wago.com/2009-113/000-007">www.wago.com/2009-113/000-007</a>
	<b>Item no.: 2009-113/000-012</b> WMB-Inline; for Smart Printer; 2300 pieces on roll; plain; snap-on type; orange	<a href="http://www.wago.com/2009-113/000-012">www.wago.com/2009-113/000-012</a>
	<b>Item no.: 2009-113/000-017</b> WMB-Inline; for Smart Printer; 2300 pieces on roll; plain; snap-on type; light green	<a href="http://www.wago.com/2009-113/000-017">www.wago.com/2009-113/000-017</a>
	<b>Item no.: 2009-113/000-023</b> WMB-Inline; for Smart Printer; 2300 pieces on roll; plain; snap-on type; green	<a href="http://www.wago.com/2009-113/000-023">www.wago.com/2009-113/000-023</a>
	<b>Item no.: 2009-113/000-024</b> WMB-Inline; for Smart Printer; 2300 pieces on roll; plain; snap-on type; violet	<a href="http://www.wago.com/2009-113/000-024">www.wago.com/2009-113/000-024</a>
	<b>Item no.: 2009-191</b> Group marker carrier	<a href="http://www.wago.com/2009-191">www.wago.com/2009-191</a>
	<b>Item no.: 793-3501</b> WMB marking card; as card; plain; snap-on type; white	<a href="http://www.wago.com/793-3501">www.wago.com/793-3501</a>
<b>ferrule</b>		
	<b>Item no.: 216-241</b> Ferrule; Sleeve for 0.5 mm <sup>2</sup> / 20 AWG; insulated; electro-tin plated; electrolytic copper; gastight crimped; acc. to DIN 46228, Part 4/09.90; white	<a href="http://www.wago.com/216-241">www.wago.com/216-241</a>
	<b>Item no.: 216-242</b> Ferrule; Sleeve for 0.75 mm <sup>2</sup> / 18 AWG; insulated; electro-tin plated; electrolytic copper; gastight crimped; acc. to DIN 46228, Part 4/09.90; gray	<a href="http://www.wago.com/216-242">www.wago.com/216-242</a>
	<b>Item no.: 216-243</b> Ferrule; Sleeve for 1 mm <sup>2</sup> / AWG 18; insulated; electro-tin plated; electrolytic copper; gastight crimped; acc. to DIN 46228, Part 4/09.90; red	<a href="http://www.wago.com/216-243">www.wago.com/216-243</a>
<b>tools</b>		
	<b>Item no.: 210-647</b> Operating tool; Blade: 2.5 x 0.4 mm; with a partially insulated shaft; multicoloured	<a href="http://www.wago.com/210-647">www.wago.com/210-647</a>
	<b>Item no.: 210-648</b> Operating tool; Blade: 2.5 x 0.4 mm; with a partially insulated shaft; angled; short	<a href="http://www.wago.com/210-648">www.wago.com/210-648</a>
	<b>Item no.: 210-719</b> Operating tool; Blade: 2.5 x 0.4 mm; with a partially insulated shaft	<a href="http://www.wago.com/210-719">www.wago.com/210-719</a>
<b>Protective Warning Marker</b>		

Subject to changes. Please also observe the further product documentation!



**Item no.: 2000-115**

Protective warning marker; with high-voltage symbol, black; for 5 terminal blocks; yellow

[www.wago.com/2000-115](http://www.wago.com/2000-115)

**Carrier rail**



**Item no.: 210-112**

Steel carrier rail; 35 x 7.5 mm; 1 mm thick; 2 m long; slotted; according to EN 60715; "Hole width 25 mm; silver-colored [www.wago.com/210-112](http://www.wago.com/210-112)



**Item no.: 210-113**

Steel carrier rail; 35 x 7.5 mm; 1 mm thick; 2 m long; unslotted; according to EN 60715; silver-colored [www.wago.com/210-113](http://www.wago.com/210-113)



**Item no.: 210-114**

Steel carrier rail; 35 x 15 mm; 1.5 mm thick; 2 m long; unslotted; similar to EN 60715; silver-colored [www.wago.com/210-114](http://www.wago.com/210-114)



**Item no.: 210-115**

Steel carrier rail; 35 x 7.5 mm; 1 mm thick; 2 m long; slotted; according to EN 60715; "Hole width 18 mm; silver-colored [www.wago.com/210-115](http://www.wago.com/210-115)



**Item no.: 210-118**

Steel carrier rail; 35 x 15 mm; 2.3 mm thick; 2 m long; unslotted; according to EN 60715; silver-colored [www.wago.com/210-118](http://www.wago.com/210-118)



**Item no.: 210-196**

Aluminum carrier rail; 35 x 8.2 mm; 1.6 mm thick; 2 m long; unslotted; similar to EN 60715; silver-colored [www.wago.com/210-196](http://www.wago.com/210-196)



**Item no.: 210-197**

Steel carrier rail; 35 x 15 mm; 1.5 mm thick; 2 m long; slotted; similar to EN 60715; silver-colored [www.wago.com/210-197](http://www.wago.com/210-197)



**Item no.: 210-198**

Copper carrier rail; 35 x 15 mm; 2.3 mm thick; 2 m long; unslotted; according to EN 60715; copper-colored [www.wago.com/210-198](http://www.wago.com/210-198)

**check**



**Item no.: 2000-510**

TOPJOB®S L-type test plug module; modular; for jumper contact slot; 1,00 mm<sup>2</sup>; gray

[www.wago.com/2000-510](http://www.wago.com/2000-510)



**Item no.: 2000-552**

Modular TOPJOB®S connector; modular; for jumper contact slot; 2-pole; 1,00 mm<sup>2</sup>; gray

[www.wago.com/2000-552](http://www.wago.com/2000-552)



**Item no.: 2000-553**

Modular TOPJOB®S connector; modular; for jumper contact slot; 3-pole; 1,00 mm<sup>2</sup>; gray

[www.wago.com/2000-553](http://www.wago.com/2000-553)



**Item no.: 2000-554**

Modular TOPJOB®S connector; modular; for jumper contact slot; 4-pole; 1,00 mm<sup>2</sup>; gray

[www.wago.com/2000-554](http://www.wago.com/2000-554)



**Item no.: 2000-555**

Modular TOPJOB®S connector; modular; for jumper contact slot; 5-pole; 1,00 mm<sup>2</sup>; gray

[www.wago.com/2000-555](http://www.wago.com/2000-555)



**Item no.: 2000-556**

Modular TOPJOB®S connector; modular; for jumper contact slot; 6-pole; 1,00 mm<sup>2</sup>; gray

[www.wago.com/2000-556](http://www.wago.com/2000-556)



**Item no.: 2000-557**

Modular TOPJOB®S connector; modular; for jumper contact slot; 7-pole; 1,00 mm<sup>2</sup>; gray

[www.wago.com/2000-557](http://www.wago.com/2000-557)



**Item no.: 2000-558**

Modular TOPJOB®S connector; modular; for jumper contact slot; 8-pole; 1,00 mm<sup>2</sup>; gray

[www.wago.com/2000-558](http://www.wago.com/2000-558)

Subject to changes. Please also observe the further product documentation!

WAGO Kontakttechnik GmbH & Co. KG

Hansastr. 27









32423 Minden

Phone: +49571 887-0 | Fax: +49571 887-169











Email: [info.de@wago.com](mailto:info.de@wago.com) | Web: [www.wago.com](http://www.wago.com)

Do you have any questions about our products?

We are always happy to take your call at +49 (571) 887-44222.











	<b>Item no.: 2000-559</b> Modular TOPJOB®S connector; modular; for jumper contact slot; 9-pole; 1,00 mm <sup>2</sup> ; gray	<a href="http://www.wago.com/2000-559">www.wago.com/2000-559</a>
	<b>Item no.: 2000-560</b> Modular TOPJOB®S connector; modular; for jumper contact slot; 10-pole; 1,00 mm <sup>2</sup> ; gray	<a href="http://www.wago.com/2000-560">www.wago.com/2000-560</a>
	<b>Item no.: 2009-174</b> Test plug adapter; for 4 mm Ø test plugs; for testing TOPJOB®S rail-mounted terminal blocks; gray	<a href="http://www.wago.com/2009-174">www.wago.com/2009-174</a>
	<b>Item no.: 2009-182</b> Testing tap; for max. 2.5 mm <sup>2</sup> ; tool-free connection for individual test wires 0.08 - 2.5 mm; gray	<a href="http://www.wago.com/2009-182">www.wago.com/2009-182</a>
<b>Female plug</b>		
	<b>Item no.: 2020-102</b> 1-conductor female plug; 1.5 mm <sup>2</sup> ; 2-pole; 1,50 mm <sup>2</sup> ; gray	<a href="http://www.wago.com/2020-102">www.wago.com/2020-102</a>
	<b>Item no.: 2020-102/122-000</b> 1-conductor female plug; Locking lever; 1.5 mm <sup>2</sup> ; 2-pole; 1,50 mm <sup>2</sup> ; gray	<a href="http://www.wago.com/2020-102/122-000">www.wago.com/2020-102/122-000</a>
	<b>Item no.: 2020-102/132-000</b> 1-conductor female plug; Strain relief plate; 1.5 mm <sup>2</sup> ; 2-pole; 1,50 mm <sup>2</sup> ; gray	<a href="http://www.wago.com/2020-102/132-000">www.wago.com/2020-102/132-000</a>
	<b>Item no.: 2020-102/142-000</b> 1-conductor female plug; Strain relief plate; 1.5 mm <sup>2</sup> ; 2-pole; 1,50 mm <sup>2</sup> ; gray	<a href="http://www.wago.com/2020-102/142-000">www.wago.com/2020-102/142-000</a>
	<b>Item no.: 2020-103</b> 1-conductor female plug; 1.5 mm <sup>2</sup> ; 3-pole; 1,50 mm <sup>2</sup> ; gray	<a href="http://www.wago.com/2020-103">www.wago.com/2020-103</a>
	<b>Item no.: 2020-103/000-036</b> 1-conductor female plug; 1.5 mm <sup>2</sup> ; 3-pole; 1,50 mm <sup>2</sup> ; gray, green-yellow	<a href="http://www.wago.com/2020-103/000-036">www.wago.com/2020-103/000-036</a>
	<b>Item no.: 2020-103/000-037</b> 1-conductor female plug; 1.5 mm <sup>2</sup> ; 3-pole; 1,50 mm <sup>2</sup> ; green-yellow, gray	<a href="http://www.wago.com/2020-103/000-037">www.wago.com/2020-103/000-037</a>
	<b>Item no.: 2020-103/000-038</b> 1-conductor female plug; 1.5 mm <sup>2</sup> ; 3-pole; 1,50 mm <sup>2</sup> ; gray, blue, green-yellow	<a href="http://www.wago.com/2020-103/000-038">www.wago.com/2020-103/000-038</a>
	<b>Item no.: 2020-103/000-039</b> 1-conductor female plug; 1.5 mm <sup>2</sup> ; 3-pole; 1,50 mm <sup>2</sup> ; green-yellow, blue, gray	<a href="http://www.wago.com/2020-103/000-039">www.wago.com/2020-103/000-039</a>
	<b>Item no.: 2020-103/122-000</b> 1-conductor female plug; Locking lever; 1.5 mm <sup>2</sup> ; 3-pole; 1,50 mm <sup>2</sup> ; gray	<a href="http://www.wago.com/2020-103/122-000">www.wago.com/2020-103/122-000</a>
	<b>Item no.: 2020-103/132-000</b> 1-conductor female plug; Strain relief plate; 1.5 mm <sup>2</sup> ; 3-pole; 1,50 mm <sup>2</sup> ; gray	<a href="http://www.wago.com/2020-103/132-000">www.wago.com/2020-103/132-000</a>

Subject to changes. Please also observe the further product documentation!







	<b>Item no.: 2020-103/142-000</b> 1-conductor female plug; Strain relief plate; 1.5 mm <sup>2</sup> ; 3-pole; 1,50 mm <sup>2</sup> ; gray	<a href="http://www.wago.com/2020-103/142-000">www.wago.com/2020-103/142-000</a>
	<b>Item no.: 2020-104</b> 1-conductor female plug; 1.5 mm <sup>2</sup> ; 4-pole; 1,50 mm <sup>2</sup> ; gray	<a href="http://www.wago.com/2020-104">www.wago.com/2020-104</a>
	<b>Item no.: 2020-104/000-036</b> 1-conductor female plug; 1.5 mm <sup>2</sup> ; 4-pole; 1,50 mm <sup>2</sup> ; gray, green-yellow	<a href="http://www.wago.com/2020-104/000-036">www.wago.com/2020-104/000-036</a>
	<b>Item no.: 2020-104/000-037</b> 1-conductor female plug; 1.5 mm <sup>2</sup> ; 4-pole; 1,50 mm <sup>2</sup> ; green-yellow, gray	<a href="http://www.wago.com/2020-104/000-037">www.wago.com/2020-104/000-037</a>
	<b>Item no.: 2020-104/000-038</b> 1-conductor female plug; 1.5 mm <sup>2</sup> ; 4-pole; 1,50 mm <sup>2</sup> ; gray, blue, green-yellow	<a href="http://www.wago.com/2020-104/000-038">www.wago.com/2020-104/000-038</a>
	<b>Item no.: 2020-104/000-039</b> 1-conductor female plug; 1.5 mm <sup>2</sup> ; 4-pole; 1,50 mm <sup>2</sup> ; green-yellow, blue, gray	<a href="http://www.wago.com/2020-104/000-039">www.wago.com/2020-104/000-039</a>
	<b>Item no.: 2020-104/124-000</b> 1-conductor female plug; Locking lever; 1.5 mm <sup>2</sup> ; 4-pole; 1,50 mm <sup>2</sup> ; gray	<a href="http://www.wago.com/2020-104/124-000">www.wago.com/2020-104/124-000</a>
	<b>Item no.: 2020-104/133-000</b> 1-conductor female plug; Strain relief plate; 1.5 mm <sup>2</sup> ; 4-pole; 1,50 mm <sup>2</sup> ; gray	<a href="http://www.wago.com/2020-104/133-000">www.wago.com/2020-104/133-000</a>
	<b>Item no.: 2020-104/143-000</b> 1-conductor female plug; Strain relief plate; 1.5 mm <sup>2</sup> ; 4-pole; 1,50 mm <sup>2</sup> ; gray	<a href="http://www.wago.com/2020-104/143-000">www.wago.com/2020-104/143-000</a>
	<b>Item no.: 2020-105</b> 1-conductor female plug; 1.5 mm <sup>2</sup> ; 5-pole; 1,50 mm <sup>2</sup> ; gray	<a href="http://www.wago.com/2020-105">www.wago.com/2020-105</a>
	<b>Item no.: 2020-105/000-036</b> 1-conductor female plug; 1.5 mm <sup>2</sup> ; 5-pole; 1,50 mm <sup>2</sup> ; gray, green-yellow	<a href="http://www.wago.com/2020-105/000-036">www.wago.com/2020-105/000-036</a>
	<b>Item no.: 2020-105/000-037</b> 1-conductor female plug; 1.5 mm <sup>2</sup> ; 5-pole; 1,50 mm <sup>2</sup> ; green-yellow, gray	<a href="http://www.wago.com/2020-105/000-037">www.wago.com/2020-105/000-037</a>
	<b>Item no.: 2020-105/000-038</b> 1-conductor female plug; 1.5 mm <sup>2</sup> ; 5-pole; 1,50 mm <sup>2</sup> ; gray, blue, green-yellow	<a href="http://www.wago.com/2020-105/000-038">www.wago.com/2020-105/000-038</a>
	<b>Item no.: 2020-105/000-039</b> 1-conductor female plug; 1.5 mm <sup>2</sup> ; 5-pole; 1,50 mm <sup>2</sup> ; green-yellow, blue, gray	<a href="http://www.wago.com/2020-105/000-039">www.wago.com/2020-105/000-039</a>

Subject to changes. Please also observe the further product documentation!



	<b>Item no.: 2020-105/124-000</b> 1-conductor female plug; Locking lever; 1.5 mm <sup>2</sup> ; 5-pole; 1,50 mm <sup>2</sup> ; gray	<a href="http://www.wago.com/2020-105/124-000">www.wago.com/2020-105/124-000</a>
	<b>Item no.: 2020-105/133-000</b> 1-conductor female plug; Strain relief plate; 1.5 mm <sup>2</sup> ; 5-pole; 1,50 mm <sup>2</sup> ; gray	<a href="http://www.wago.com/2020-105/133-000">www.wago.com/2020-105/133-000</a>
	<b>Item no.: 2020-105/143-000</b> 1-conductor female plug; Strain relief plate; 1.5 mm <sup>2</sup> ; 5-pole; 1,50 mm <sup>2</sup> ; gray	<a href="http://www.wago.com/2020-105/143-000">www.wago.com/2020-105/143-000</a>
	<b>Item no.: 2020-106</b> 1-conductor female plug; 1.5 mm <sup>2</sup> ; 6-pole; 1,50 mm <sup>2</sup> ; gray	<a href="http://www.wago.com/2020-106">www.wago.com/2020-106</a>
	<b>Item no.: 2020-106/000-036</b> 1-conductor female plug; 1.5 mm <sup>2</sup> ; 6-pole; 1,50 mm <sup>2</sup> ; gray, green-yellow	<a href="http://www.wago.com/2020-106/000-036">www.wago.com/2020-106/000-036</a>
	<b>Item no.: 2020-106/000-037</b> 1-conductor female plug; 1.5 mm <sup>2</sup> ; 6-pole; 1,50 mm <sup>2</sup> ; green-yellow, gray	<a href="http://www.wago.com/2020-106/000-037">www.wago.com/2020-106/000-037</a>
	<b>Item no.: 2020-106/000-038</b> 1-conductor female plug; 1.5 mm <sup>2</sup> ; 6-pole; 1,50 mm <sup>2</sup> ; gray, blue, green-yellow	<a href="http://www.wago.com/2020-106/000-038">www.wago.com/2020-106/000-038</a>
	<b>Item no.: 2020-106/000-039</b> 1-conductor female plug; 1.5 mm <sup>2</sup> ; 6-pole; 1,50 mm <sup>2</sup> ; green-yellow, blue, gray	<a href="http://www.wago.com/2020-106/000-039">www.wago.com/2020-106/000-039</a>
	<b>Item no.: 2020-106/124-000</b> 1-conductor female plug; Locking lever; 1.5 mm <sup>2</sup> ; 6-pole; 1,50 mm <sup>2</sup> ; gray	<a href="http://www.wago.com/2020-106/124-000">www.wago.com/2020-106/124-000</a>
	<b>Item no.: 2020-106/133-000</b> 1-conductor female plug; Strain relief plate; 1.5 mm <sup>2</sup> ; 6-pole; 1,50 mm <sup>2</sup> ; gray	<a href="http://www.wago.com/2020-106/133-000">www.wago.com/2020-106/133-000</a>
	<b>Item no.: 2020-106/143-000</b> 1-conductor female plug; Strain relief plate; 1.5 mm <sup>2</sup> ; 6-pole; 1,50 mm <sup>2</sup> ; gray	<a href="http://www.wago.com/2020-106/143-000">www.wago.com/2020-106/143-000</a>
	<b>Item no.: 2020-107</b> 1-conductor female plug; 1.5 mm <sup>2</sup> ; 7-pole; 1,50 mm <sup>2</sup> ; gray	<a href="http://www.wago.com/2020-107">www.wago.com/2020-107</a>
	<b>Item no.: 2020-107/000-036</b> 1-conductor female plug; 1.5 mm <sup>2</sup> ; 7-pole; 1,50 mm <sup>2</sup> ; gray, green-yellow	<a href="http://www.wago.com/2020-107/000-036">www.wago.com/2020-107/000-036</a>
	<b>Item no.: 2020-107/000-037</b> 1-conductor female plug; 1.5 mm <sup>2</sup> ; 7-pole; 1,50 mm <sup>2</sup> ; green-yellow, gray	<a href="http://www.wago.com/2020-107/000-037">www.wago.com/2020-107/000-037</a>

Subject to changes. Please also observe the further product documentation!

	<b>Item no.: 2020-107/000-038</b> 1-conductor female plug; 1.5 mm <sup>2</sup> ; 7-pole; 1,50 mm <sup>2</sup> ; gray, blue, green-yellow	<a href="http://www.wago.com/2020-107/000-038">www.wago.com/2020-107/000-038</a>
	<b>Item no.: 2020-107/000-039</b> 1-conductor female plug; 1.5 mm <sup>2</sup> ; 7-pole; 1,50 mm <sup>2</sup> ; green-yellow, blue, gray	<a href="http://www.wago.com/2020-107/000-039">www.wago.com/2020-107/000-039</a>
	<b>Item no.: 2020-107/124-000</b> 1-conductor female plug; Locking lever; 1.5 mm <sup>2</sup> ; 7-pole; 1,50 mm <sup>2</sup> ; gray	<a href="http://www.wago.com/2020-107/124-000">www.wago.com/2020-107/124-000</a>
	<b>Item no.: 2020-107/134-000</b> 1-conductor female plug; Strain relief plate; 1.5 mm <sup>2</sup> ; 7-pole; 1,50 mm <sup>2</sup> ; gray	<a href="http://www.wago.com/2020-107/134-000">www.wago.com/2020-107/134-000</a>
	<b>Item no.: 2020-107/144-000</b> 1-conductor female plug; Strain relief plate; 1.5 mm <sup>2</sup> ; 7-pole; 1,50 mm <sup>2</sup> ; gray	<a href="http://www.wago.com/2020-107/144-000">www.wago.com/2020-107/144-000</a>
	<b>Item no.: 2020-108</b> 1-conductor female plug; 1.5 mm <sup>2</sup> ; 8-pole; 1,50 mm <sup>2</sup> ; gray	<a href="http://www.wago.com/2020-108">www.wago.com/2020-108</a>
	<b>Item no.: 2020-108/000-036</b> 1-conductor female plug; 1.5 mm <sup>2</sup> ; 8-pole; 1,50 mm <sup>2</sup> ; gray, green-yellow	<a href="http://www.wago.com/2020-108/000-036">www.wago.com/2020-108/000-036</a>
	<b>Item no.: 2020-108/000-037</b> 1-conductor female plug; 1.5 mm <sup>2</sup> ; 8-pole; 1,50 mm <sup>2</sup> ; green-yellow, gray	<a href="http://www.wago.com/2020-108/000-037">www.wago.com/2020-108/000-037</a>
	<b>Item no.: 2020-108/000-038</b> 1-conductor female plug; 1.5 mm <sup>2</sup> ; 8-pole; 1,50 mm <sup>2</sup> ; gray, blue, green-yellow	<a href="http://www.wago.com/2020-108/000-038">www.wago.com/2020-108/000-038</a>
	<b>Item no.: 2020-108/000-039</b> 1-conductor female plug; 1.5 mm <sup>2</sup> ; 8-pole; 1,50 mm <sup>2</sup> ; green-yellow, blue, gray	<a href="http://www.wago.com/2020-108/000-039">www.wago.com/2020-108/000-039</a>
	<b>Item no.: 2020-108/124-000</b> 1-conductor female plug; Locking lever; 1.5 mm <sup>2</sup> ; 8-pole; 1,50 mm <sup>2</sup> ; gray	<a href="http://www.wago.com/2020-108/124-000">www.wago.com/2020-108/124-000</a>
	<b>Item no.: 2020-108/134-000</b> 1-conductor female plug; Strain relief plate; 1.5 mm <sup>2</sup> ; 8-pole; 1,50 mm <sup>2</sup> ; gray	<a href="http://www.wago.com/2020-108/134-000">www.wago.com/2020-108/134-000</a>
	<b>Item no.: 2020-108/144-000</b> 1-conductor female plug; Strain relief plate; 1.5 mm <sup>2</sup> ; 8-pole; 1,50 mm <sup>2</sup> ; gray	<a href="http://www.wago.com/2020-108/144-000">www.wago.com/2020-108/144-000</a>

Subject to changes. Please also observe the further product documentation!



**Item no.: 2020-109**

1-conductor female plug; 1.5 mm<sup>2</sup>; 9-pole; 1,50 mm<sup>2</sup>; gray

[www.wago.com/2020-109](http://www.wago.com/2020-109)



**Item no.: 2020-109/000-036**

1-conductor female plug; 1.5 mm<sup>2</sup>; 9-pole; 1,50 mm<sup>2</sup>; gray, green-yellow

[www.wago.com/2020-109/000-036](http://www.wago.com/2020-109/000-036)



**Item no.: 2020-109/000-037**

1-conductor female plug; 1.5 mm<sup>2</sup>; 9-pole; 1,50 mm<sup>2</sup>; green-yellow, gray

[www.wago.com/2020-109/000-037](http://www.wago.com/2020-109/000-037)



**Item no.: 2020-109/000-038**

1-conductor female plug; 1.5 mm<sup>2</sup>; 9-pole; 1,50 mm<sup>2</sup>; gray, blue, green-yellow

[www.wago.com/2020-109/000-038](http://www.wago.com/2020-109/000-038)



**Item no.: 2020-109/000-039**

1-conductor female plug; 1.5 mm<sup>2</sup>; 9-pole; 1,50 mm<sup>2</sup>; green-yellow, blue, gray

[www.wago.com/2020-109/000-039](http://www.wago.com/2020-109/000-039)

**Item no.: 2020-109/124-000**

1-conductor female plug; Locking lever; 1.5 mm<sup>2</sup>; 9-pole; 1,50 mm<sup>2</sup>; gray

[www.wago.com/2020-109/124-000](http://www.wago.com/2020-109/124-000)

**Item no.: 2020-109/134-000**

1-conductor female plug; Strain relief plate; 1.5 mm<sup>2</sup>; 9-pole; 1,50 mm<sup>2</sup>; gray

[www.wago.com/2020-109/134-000](http://www.wago.com/2020-109/134-000)

**Item no.: 2020-109/144-000**

1-conductor female plug; Strain relief plate; 1.5 mm<sup>2</sup>; 9-pole; 1,50 mm<sup>2</sup>; gray

[www.wago.com/2020-109/144-000](http://www.wago.com/2020-109/144-000)



**Item no.: 2020-110**

1-conductor female plug; 1.5 mm<sup>2</sup>; 10-pole; 1,50 mm<sup>2</sup>; gray

[www.wago.com/2020-110](http://www.wago.com/2020-110)



**Item no.: 2020-110/000-036**

1-conductor female plug; 1.5 mm<sup>2</sup>; 10-pole; 1,50 mm<sup>2</sup>; gray, green-yellow

[www.wago.com/2020-110/000-036](http://www.wago.com/2020-110/000-036)



**Item no.: 2020-110/000-037**

1-conductor female plug; 1.5 mm<sup>2</sup>; 10-pole; 1,50 mm<sup>2</sup>; green-yellow, gray

[www.wago.com/2020-110/000-037](http://www.wago.com/2020-110/000-037)



**Item no.: 2020-110/000-038**

1-conductor female plug; 1.5 mm<sup>2</sup>; 10-pole; 1,50 mm<sup>2</sup>; gray, blue, green-yellow

[www.wago.com/2020-110/000-038](http://www.wago.com/2020-110/000-038)



**Item no.: 2020-110/000-039**

1-conductor female plug; 1.5 mm<sup>2</sup>; 10-pole; 1,50 mm<sup>2</sup>; green-yellow, blue, gray

[www.wago.com/2020-110/000-039](http://www.wago.com/2020-110/000-039)

**Item no.: 2020-110/125-000**

1-conductor female plug; Locking lever; 1.5 mm<sup>2</sup>; 10-pole; 1,50 mm<sup>2</sup>; gray

[www.wago.com/2020-110/125-000](http://www.wago.com/2020-110/125-000)

Subject to changes. Please also observe the further product documentation!

WAGO Kontakttechnik GmbH & Co. KG

Hansastr. 27









32423 Minden

Phone: +49571 887-0 | Fax: +49571 887-169

Email: [info.de@wago.com](mailto:info.de@wago.com) | Web: [www.wago.com](http://www.wago.com)

Do you have any questions about our products?

We are always happy to take your call at +49 (571) 887-44222.

	<b>Item no.: 2020-110/135-000</b> 1-conductor female plug; Strain relief plate; 1.5 mm <sup>2</sup> ; 10-pole; 1,50 mm <sup>2</sup> ; gray	<a href="http://www.wago.com/2020-110/135-000">www.wago.com/2020-110/135-000</a>
	<b>Item no.: 2020-110/145-000</b> 1-conductor female plug; Strain relief plate; 1.5 mm <sup>2</sup> ; 10-pole; 1,50 mm <sup>2</sup> ; gray	<a href="http://www.wago.com/2020-110/145-000">www.wago.com/2020-110/145-000</a>
	<b>Item no.: 2020-111</b> 1-conductor female plug; 1.5 mm <sup>2</sup> ; 11-pole; 1,50 mm <sup>2</sup> ; gray	<a href="http://www.wago.com/2020-111">www.wago.com/2020-111</a>
	<b>Item no.: 2020-111/000-036</b> 1-conductor female plug; 1.5 mm <sup>2</sup> ; 11-pole; 1,50 mm <sup>2</sup> ; gray, green-yellow	<a href="http://www.wago.com/2020-111/000-036">www.wago.com/2020-111/000-036</a>
	<b>Item no.: 2020-111/000-037</b> 1-conductor female plug; 1.5 mm <sup>2</sup> ; 11-pole; 1,50 mm <sup>2</sup> ; green-yellow, gray	<a href="http://www.wago.com/2020-111/000-037">www.wago.com/2020-111/000-037</a>
	<b>Item no.: 2020-111/000-038</b> 1-conductor female plug; 1.5 mm <sup>2</sup> ; 11-pole; 1,50 mm <sup>2</sup> ; gray, blue, green-yellow	<a href="http://www.wago.com/2020-111/000-038">www.wago.com/2020-111/000-038</a>
	<b>Item no.: 2020-111/000-039</b> 1-conductor female plug; 1.5 mm <sup>2</sup> ; 11-pole; 1,50 mm <sup>2</sup> ; green-yellow, blue, gray	<a href="http://www.wago.com/2020-111/000-039">www.wago.com/2020-111/000-039</a>
	<b>Item no.: 2020-111/125-000</b> 1-conductor female plug; Locking lever; 1.5 mm <sup>2</sup> ; 11-pole; 1,50 mm <sup>2</sup> ; gray	<a href="http://www.wago.com/2020-111/125-000">www.wago.com/2020-111/125-000</a>
	<b>Item no.: 2020-111/135-000</b> 1-conductor female plug; Strain relief plate; 1.5 mm <sup>2</sup> ; 11-pole; 1,50 mm <sup>2</sup> ; gray	<a href="http://www.wago.com/2020-111/135-000">www.wago.com/2020-111/135-000</a>
	<b>Item no.: 2020-111/145-000</b> 1-conductor female plug; Strain relief plate; 1.5 mm <sup>2</sup> ; 11-pole; 1,50 mm <sup>2</sup> ; gray	<a href="http://www.wago.com/2020-111/145-000">www.wago.com/2020-111/145-000</a>
	<b>Item no.: 2020-112</b> 1-conductor female plug; 1.5 mm <sup>2</sup> ; 12-pole; 1,50 mm <sup>2</sup> ; gray	<a href="http://www.wago.com/2020-112">www.wago.com/2020-112</a>
	<b>Item no.: 2020-112/000-036</b> 1-conductor female plug; 1.5 mm <sup>2</sup> ; 12-pole; 1,50 mm <sup>2</sup> ; gray, green-yellow	<a href="http://www.wago.com/2020-112/000-036">www.wago.com/2020-112/000-036</a>
	<b>Item no.: 2020-112/000-037</b> 1-conductor female plug; 1.5 mm <sup>2</sup> ; 12-pole; 1,50 mm <sup>2</sup> ; green-yellow, gray	<a href="http://www.wago.com/2020-112/000-037">www.wago.com/2020-112/000-037</a>
	<b>Item no.: 2020-112/000-038</b> 1-conductor female plug; 1.5 mm <sup>2</sup> ; 12-pole; 1,50 mm <sup>2</sup> ; gray, blue, green-yellow	<a href="http://www.wago.com/2020-112/000-038">www.wago.com/2020-112/000-038</a>

Subject to changes. Please also observe the further product documentation!



**Item no.: 2020-112/000-039**

1-conductor female plug; 1.5 mm<sup>2</sup>; 12-pole; 1,50 mm<sup>2</sup>; green-yellow, blue, gray

[www.wago.com/2020-112/000-039](http://www.wago.com/2020-112/000-039)

**Item no.: 2020-112/125-000**

1-conductor female plug; Locking lever; 1.5 mm<sup>2</sup>; 12-pole; 1,50 mm<sup>2</sup>; gray

[www.wago.com/2020-112/125-000](http://www.wago.com/2020-112/125-000)

**Item no.: 2020-112/135-000**

1-conductor female plug; Strain relief plate; 1.5 mm<sup>2</sup>; 12-pole; 1,50 mm<sup>2</sup>; gray

[www.wago.com/2020-112/135-000](http://www.wago.com/2020-112/135-000)

**Item no.: 2020-112/145-000**

1-conductor female plug; Strain relief plate; 1.5 mm<sup>2</sup>; 12-pole; 1,50 mm<sup>2</sup>; gray

[www.wago.com/2020-112/145-000](http://www.wago.com/2020-112/145-000)



**Item no.: 2020-113**

1-conductor female plug; 1.5 mm<sup>2</sup>; 13-pole; 1,50 mm<sup>2</sup>; gray

[www.wago.com/2020-113](http://www.wago.com/2020-113)



**Item no.: 2020-113/000-036**

1-conductor female plug; 1.5 mm<sup>2</sup>; 13-pole; 1,50 mm<sup>2</sup>; gray, green-yellow

[www.wago.com/2020-113/000-036](http://www.wago.com/2020-113/000-036)



**Item no.: 2020-113/000-037**

1-conductor female plug; 1.5 mm<sup>2</sup>; 13-pole; 1,50 mm<sup>2</sup>; green-yellow, gray

[www.wago.com/2020-113/000-037](http://www.wago.com/2020-113/000-037)



**Item no.: 2020-113/000-038**

1-conductor female plug; 1.5 mm<sup>2</sup>; 13-pole; 1,50 mm<sup>2</sup>; gray, blue, green-yellow

[www.wago.com/2020-113/000-038](http://www.wago.com/2020-113/000-038)



**Item no.: 2020-113/000-039**

1-conductor female plug; 1.5 mm<sup>2</sup>; 13-pole; 1,50 mm<sup>2</sup>; green-yellow, blue, gray

[www.wago.com/2020-113/000-039](http://www.wago.com/2020-113/000-039)

**Item no.: 2020-113/125-000**

1-conductor female plug; Locking lever; 1.5 mm<sup>2</sup>; 13-pole; 1,50 mm<sup>2</sup>; gray

[www.wago.com/2020-113/125-000](http://www.wago.com/2020-113/125-000)

**Item no.: 2020-113/135-000**

1-conductor female plug; Strain relief plate; 1.5 mm<sup>2</sup>; 13-pole; 1,50 mm<sup>2</sup>; gray

[www.wago.com/2020-113/135-000](http://www.wago.com/2020-113/135-000)

**Item no.: 2020-113/145-000**

1-conductor female plug; Strain relief plate; 1.5 mm<sup>2</sup>; 13-pole; 1,50 mm<sup>2</sup>; gray

[www.wago.com/2020-113/145-000](http://www.wago.com/2020-113/145-000)



**Item no.: 2020-114**

1-conductor female plug; 1.5 mm<sup>2</sup>; 14-pole; 1,50 mm<sup>2</sup>; gray

[www.wago.com/2020-114](http://www.wago.com/2020-114)



**Item no.: 2020-114/000-036**

1-conductor female plug; 1.5 mm<sup>2</sup>; 14-pole; 1,50 mm<sup>2</sup>; gray, green-yellow

[www.wago.com/2020-114/000-036](http://www.wago.com/2020-114/000-036)

Subject to changes. Please also observe the further product documentation!

WAGO Kontakttechnik GmbH & Co. KG

Hansastr. 27

32423 Minden

Phone: +49571 887-0 | Fax: +49571 887-169

Email: [info.de@wago.com](mailto:info.de@wago.com) | Web: [www.wago.com](http://www.wago.com)

Do you have any questions about our products?

We are always happy to take your call at +49 (571) 887-44222.



**Item no.: 2020-114/000-037**

1-conductor female plug; 1.5 mm<sup>2</sup>; 14-pole; 1,50 mm<sup>2</sup>; green-yellow, gray

[www.wago.com/2020-114/000-037](http://www.wago.com/2020-114/000-037)



**Item no.: 2020-114/000-038**

1-conductor female plug; 1.5 mm<sup>2</sup>; 14-pole; 1,50 mm<sup>2</sup>; gray, blue, green-yellow

[www.wago.com/2020-114/000-038](http://www.wago.com/2020-114/000-038)



**Item no.: 2020-114/000-039**

1-conductor female plug; 1.5 mm<sup>2</sup>; 14-pole; 1,50 mm<sup>2</sup>; green-yellow, blue, gray

[www.wago.com/2020-114/000-039](http://www.wago.com/2020-114/000-039)

**Item no.: 2020-114/125-000**

1-conductor female plug; Locking lever; 1.5 mm<sup>2</sup>; 14-pole; 1,50 mm<sup>2</sup>; gray

[www.wago.com/2020-114/125-000](http://www.wago.com/2020-114/125-000)

**Item no.: 2020-114/135-000**

1-conductor female plug; Strain relief plate; 1.5 mm<sup>2</sup>; 14-pole; 1,50 mm<sup>2</sup>; gray

[www.wago.com/2020-114/135-000](http://www.wago.com/2020-114/135-000)

**Item no.: 2020-114/145-000**

1-conductor female plug; Strain relief plate; 1.5 mm<sup>2</sup>; 14-pole; 1,50 mm<sup>2</sup>; gray

[www.wago.com/2020-114/145-000](http://www.wago.com/2020-114/145-000)



**Item no.: 2020-115**

1-conductor female plug; 1.5 mm<sup>2</sup>; 15-pole; 1,50 mm<sup>2</sup>; gray

[www.wago.com/2020-115](http://www.wago.com/2020-115)



**Item no.: 2020-115/000-036**

1-conductor female plug; 1.5 mm<sup>2</sup>; 15-pole; 1,50 mm<sup>2</sup>; gray, green-yellow

[www.wago.com/2020-115/000-036](http://www.wago.com/2020-115/000-036)



**Item no.: 2020-115/000-037**

1-conductor female plug; 1.5 mm<sup>2</sup>; 15-pole; 1,50 mm<sup>2</sup>; green-yellow, gray

[www.wago.com/2020-115/000-037](http://www.wago.com/2020-115/000-037)



**Item no.: 2020-115/000-038**

1-conductor female plug; 1.5 mm<sup>2</sup>; 15-pole; 1,50 mm<sup>2</sup>; gray, blue, green-yellow

[www.wago.com/2020-115/000-038](http://www.wago.com/2020-115/000-038)



**Item no.: 2020-115/000-039**

1-conductor female plug; 1.5 mm<sup>2</sup>; 15-pole; 1,50 mm<sup>2</sup>; green-yellow, blue, gray

[www.wago.com/2020-115/000-039](http://www.wago.com/2020-115/000-039)

**Item no.: 2020-115/125-000**

1-conductor female plug; Locking lever; 1.5 mm<sup>2</sup>; 15-pole; 1,50 mm<sup>2</sup>; gray

[www.wago.com/2020-115/125-000](http://www.wago.com/2020-115/125-000)

**Item no.: 2020-115/135-000**

1-conductor female plug; Strain relief plate; 1.5 mm<sup>2</sup>; 15-pole; 1,50 mm<sup>2</sup>; gray

[www.wago.com/2020-115/135-000](http://www.wago.com/2020-115/135-000)

**Item no.: 2020-115/145-000**

1-conductor female plug; Strain relief plate; 1.5 mm<sup>2</sup>; 15-pole; 1,50 mm<sup>2</sup>; gray

[www.wago.com/2020-115/145-000](http://www.wago.com/2020-115/145-000)

Subject to changes. Please also observe the further product documentation!

WAGO Kontakttechnik GmbH & Co. KG

Hansastr. 27















32423 Minden

Phone: +49571 887-0 | Fax: +49571 887-169















Email: [info.de@wago.com](mailto:info.de@wago.com) | Web: [www.wago.com](http://www.wago.com)

Do you have any questions about our products?

We are always happy to take your call at +49 (571) 887-44222.















	<b>Item no.: 2020-161</b> Start module for 1-conductor female connector; with integrated end plate; 1.5 mm <sup>2</sup> ; 1-pole; 1,50 mm <sup>2</sup> ; gray	<a href="http://www.wago.com/2020-161">www.wago.com/2020-161</a>
	<b>Item no.: 2020-164</b> Start module for 1-conductor female connector; with integrated end plate; 1.5 mm <sup>2</sup> ; 1-pole; 1,50 mm <sup>2</sup> ; blue	<a href="http://www.wago.com/2020-164">www.wago.com/2020-164</a>
	<b>Item no.: 2020-167</b> Start module for 1-conductor female connector; 1.5 mm <sup>2</sup> ; 1-pole; 1,50 mm <sup>2</sup> ; green-yellow	<a href="http://www.wago.com/2020-167">www.wago.com/2020-167</a>
	<b>Item no.: 2020-181</b> End module for 1-conductor female connector; 1.5 mm <sup>2</sup> ; 1-pole; 1,50 mm <sup>2</sup> ; gray	<a href="http://www.wago.com/2020-181">www.wago.com/2020-181</a>
	<b>Item no.: 2020-184</b> End module for 1-conductor female connector; 1.5 mm <sup>2</sup> ; 1-pole; 1,50 mm <sup>2</sup> ; blue	<a href="http://www.wago.com/2020-184">www.wago.com/2020-184</a>
	<b>Item no.: 2020-187</b> End module for 1-conductor female connector; 1.5 mm <sup>2</sup> ; 1-pole; 1,50 mm <sup>2</sup> ; green-yellow	<a href="http://www.wago.com/2020-187">www.wago.com/2020-187</a>
	<b>Item no.: 2020-202</b> 2-conductor female connector; 1.5 mm <sup>2</sup> ; 2-pole; 1,50 mm <sup>2</sup> ; gray	<a href="http://www.wago.com/2020-202">www.wago.com/2020-202</a>
	<b>Item no.: 2020-203</b> 2-conductor female connector; 1.5 mm <sup>2</sup> ; 3-pole; 1,50 mm <sup>2</sup> ; gray	<a href="http://www.wago.com/2020-203">www.wago.com/2020-203</a>
	<b>Item no.: 2020-203/000-036</b> 2-conductor female connector; 1.5 mm <sup>2</sup> ; 3-pole; 1,50 mm <sup>2</sup> ; gray, green-yellow	<a href="http://www.wago.com/2020-203/000-036">www.wago.com/2020-203/000-036</a>
	<b>Item no.: 2020-203/000-037</b> 2-conductor female connector; 1.5 mm <sup>2</sup> ; 3-pole; 1,50 mm <sup>2</sup> ; green-yellow, gray	<a href="http://www.wago.com/2020-203/000-037">www.wago.com/2020-203/000-037</a>
	<b>Item no.: 2020-203/000-038</b> 2-conductor female connector; 1.5 mm <sup>2</sup> ; 3-pole; 1,50 mm <sup>2</sup> ; gray, blue, green-yellow	<a href="http://www.wago.com/2020-203/000-038">www.wago.com/2020-203/000-038</a>
	<b>Item no.: 2020-203/000-039</b> 2-conductor female connector; 1.5 mm <sup>2</sup> ; 3-pole; 1,50 mm <sup>2</sup> ; green-yellow, blue, gray	<a href="http://www.wago.com/2020-203/000-039">www.wago.com/2020-203/000-039</a>
	<b>Item no.: 2020-204</b> 2-conductor female connector; 1.5 mm <sup>2</sup> ; 4-pole; 1,50 mm <sup>2</sup> ; gray	<a href="http://www.wago.com/2020-204">www.wago.com/2020-204</a>
	<b>Item no.: 2020-204/000-036</b> 2-conductor female connector; 1.5 mm <sup>2</sup> ; 4-pole; 1,50 mm <sup>2</sup> ; gray, green-yellow	<a href="http://www.wago.com/2020-204/000-036">www.wago.com/2020-204/000-036</a>
	<b>Item no.: 2020-204/000-037</b> 2-conductor female connector; 1.5 mm <sup>2</sup> ; 4-pole; 1,50 mm <sup>2</sup> ; green-yellow, gray	<a href="http://www.wago.com/2020-204/000-037">www.wago.com/2020-204/000-037</a>

Subject to changes. Please also observe the further product documentation!

	<b>Item no.: 2020-204/000-038</b> 2-conductor female connector; 1.5 mm <sup>2</sup> ; 4-pole; 1,50 mm <sup>2</sup> ; gray, blue, green-yellow	<a href="http://www.wago.com/2020-204/000-038">www.wago.com/2020-204/000-038</a>
	<b>Item no.: 2020-204/000-039</b> 2-conductor female connector; 1.5 mm <sup>2</sup> ; 4-pole; 1,50 mm <sup>2</sup> ; green-yellow, blue, gray	<a href="http://www.wago.com/2020-204/000-039">www.wago.com/2020-204/000-039</a>
	<b>Item no.: 2020-205</b> 2-conductor female connector; 1.5 mm <sup>2</sup> ; 5-pole; 1,50 mm <sup>2</sup> ; gray	<a href="http://www.wago.com/2020-205">www.wago.com/2020-205</a>
	<b>Item no.: 2020-205/000-036</b> 2-conductor female connector; 1.5 mm <sup>2</sup> ; 5-pole; 1,50 mm <sup>2</sup> ; gray, green-yellow	<a href="http://www.wago.com/2020-205/000-036">www.wago.com/2020-205/000-036</a>
	<b>Item no.: 2020-205/000-037</b> 2-conductor female connector; 1.5 mm <sup>2</sup> ; 5-pole; 1,50 mm <sup>2</sup> ; green-yellow, gray	<a href="http://www.wago.com/2020-205/000-037">www.wago.com/2020-205/000-037</a>
	<b>Item no.: 2020-205/000-038</b> 2-conductor female connector; 1.5 mm <sup>2</sup> ; 5-pole; 1,50 mm <sup>2</sup> ; gray, blue, green-yellow	<a href="http://www.wago.com/2020-205/000-038">www.wago.com/2020-205/000-038</a>
	<b>Item no.: 2020-205/000-039</b> 2-conductor female connector; 1.5 mm <sup>2</sup> ; 5-pole; 1,50 mm <sup>2</sup> ; green-yellow, blue, gray	<a href="http://www.wago.com/2020-205/000-039">www.wago.com/2020-205/000-039</a>
	<b>Item no.: 2020-206</b> 2-conductor female connector; 1.5 mm <sup>2</sup> ; 6-pole; 1,50 mm <sup>2</sup> ; gray	<a href="http://www.wago.com/2020-206">www.wago.com/2020-206</a>
	<b>Item no.: 2020-206/000-036</b> 2-conductor female connector; 1.5 mm <sup>2</sup> ; 6-pole; 1,50 mm <sup>2</sup> ; gray, green-yellow	<a href="http://www.wago.com/2020-206/000-036">www.wago.com/2020-206/000-036</a>
	<b>Item no.: 2020-206/000-037</b> 2-conductor female connector; 1.5 mm <sup>2</sup> ; 6-pole; 1,50 mm <sup>2</sup> ; green-yellow, gray	<a href="http://www.wago.com/2020-206/000-037">www.wago.com/2020-206/000-037</a>
	<b>Item no.: 2020-206/000-038</b> 2-conductor female connector; 1.5 mm <sup>2</sup> ; 6-pole; 1,50 mm <sup>2</sup> ; gray, blue, green-yellow	<a href="http://www.wago.com/2020-206/000-038">www.wago.com/2020-206/000-038</a>
	<b>Item no.: 2020-206/000-039</b> 2-conductor female connector; 1.5 mm <sup>2</sup> ; 6-pole; 1,50 mm <sup>2</sup> ; green-yellow, blue, gray	<a href="http://www.wago.com/2020-206/000-039">www.wago.com/2020-206/000-039</a>
	<b>Item no.: 2020-207</b> 2-conductor female connector; 1.5 mm <sup>2</sup> ; 7-pole; 1,50 mm <sup>2</sup> ; gray	<a href="http://www.wago.com/2020-207">www.wago.com/2020-207</a>
	<b>Item no.: 2020-207/000-036</b> 2-conductor female connector; 1.5 mm <sup>2</sup> ; 7-pole; 1,50 mm <sup>2</sup> ; gray, green-yellow	<a href="http://www.wago.com/2020-207/000-036">www.wago.com/2020-207/000-036</a>

Subject to changes. Please also observe the further product documentation!



	<b>Item no.: 2020-207/000-037</b> 2-conductor female connector; 1.5 mm <sup>2</sup> ; 7-pole; 1,50 mm <sup>2</sup> ; green-yellow, gray	<a href="http://www.wago.com/2020-207/000-037">www.wago.com/2020-207/000-037</a>
	<b>Item no.: 2020-207/000-038</b> 2-conductor female connector; 1.5 mm <sup>2</sup> ; 7-pole; 1,50 mm <sup>2</sup> ; gray, blue, green-yellow	<a href="http://www.wago.com/2020-207/000-038">www.wago.com/2020-207/000-038</a>
	<b>Item no.: 2020-207/000-039</b> 2-conductor female connector; 1.5 mm <sup>2</sup> ; 7-pole; 1,50 mm <sup>2</sup> ; green-yellow, blue, gray	<a href="http://www.wago.com/2020-207/000-039">www.wago.com/2020-207/000-039</a>
	<b>Item no.: 2020-208</b> 2-conductor female connector; 1.5 mm <sup>2</sup> ; 8-pole; 1,50 mm <sup>2</sup> ; gray	<a href="http://www.wago.com/2020-208">www.wago.com/2020-208</a>
	<b>Item no.: 2020-208/000-036</b> 2-conductor female connector; 1.5 mm <sup>2</sup> ; 8-pole; 1,50 mm <sup>2</sup> ; gray, green-yellow	<a href="http://www.wago.com/2020-208/000-036">www.wago.com/2020-208/000-036</a>
	<b>Item no.: 2020-208/000-037</b> 2-conductor female connector; 1.5 mm <sup>2</sup> ; 8-pole; 1,50 mm <sup>2</sup> ; green-yellow, gray	<a href="http://www.wago.com/2020-208/000-037">www.wago.com/2020-208/000-037</a>
	<b>Item no.: 2020-208/000-038</b> 2-conductor female connector; 1.5 mm <sup>2</sup> ; 8-pole; 1,50 mm <sup>2</sup> ; gray, blue, green-yellow	<a href="http://www.wago.com/2020-208/000-038">www.wago.com/2020-208/000-038</a>
	<b>Item no.: 2020-208/000-039</b> 2-conductor female connector; 1.5 mm <sup>2</sup> ; 8-pole; 1,50 mm <sup>2</sup> ; green-yellow, blue, gray	<a href="http://www.wago.com/2020-208/000-039">www.wago.com/2020-208/000-039</a>
	<b>Item no.: 2020-209</b> 2-conductor female connector; 1.5 mm <sup>2</sup> ; 9-pole; 1,50 mm <sup>2</sup> ; gray	<a href="http://www.wago.com/2020-209">www.wago.com/2020-209</a>
	<b>Item no.: 2020-209/000-036</b> 2-conductor female connector; 1.5 mm <sup>2</sup> ; 9-pole; 1,50 mm <sup>2</sup> ; gray, green-yellow	<a href="http://www.wago.com/2020-209/000-036">www.wago.com/2020-209/000-036</a>
	<b>Item no.: 2020-209/000-037</b> 2-conductor female connector; 1.5 mm <sup>2</sup> ; 9-pole; 1,50 mm <sup>2</sup> ; green-yellow, gray	<a href="http://www.wago.com/2020-209/000-037">www.wago.com/2020-209/000-037</a>
	<b>Item no.: 2020-209/000-038</b> 2-conductor female connector; 1.5 mm <sup>2</sup> ; 9-pole; 1,50 mm <sup>2</sup> ; gray, blue, green-yellow	<a href="http://www.wago.com/2020-209/000-038">www.wago.com/2020-209/000-038</a>
	<b>Item no.: 2020-209/000-039</b> 2-conductor female connector; 1.5 mm <sup>2</sup> ; 9-pole; 1,50 mm <sup>2</sup> ; green-yellow, blue, gray	<a href="http://www.wago.com/2020-209/000-039">www.wago.com/2020-209/000-039</a>
	<b>Item no.: 2020-210</b> 2-conductor female connector; 1.5 mm <sup>2</sup> ; 10-pole; 1,50 mm <sup>2</sup> ; gray	<a href="http://www.wago.com/2020-210">www.wago.com/2020-210</a>

Subject to changes. Please also observe the further product documentation!



**Item no.: 2020-210/000-036**  
2-conductor female connector; 1.5 mm<sup>2</sup>; 10-pole; 1,50 mm<sup>2</sup>; gray, green-yellow

[www.wago.com/2020-210/000-036](http://www.wago.com/2020-210/000-036)



**Item no.: 2020-210/000-037**  
2-conductor female connector; 1.5 mm<sup>2</sup>; 10-pole; 1,50 mm<sup>2</sup>; green-yellow, gray

[www.wago.com/2020-210/000-037](http://www.wago.com/2020-210/000-037)



**Item no.: 2020-210/000-038**  
2-conductor female connector; 1.5 mm<sup>2</sup>; 10-pole; 1,50 mm<sup>2</sup>; gray, blue, green-yellow

[www.wago.com/2020-210/000-038](http://www.wago.com/2020-210/000-038)



**Item no.: 2020-210/000-039**  
2-conductor female connector; 1.5 mm<sup>2</sup>; 10-pole; 1,50 mm<sup>2</sup>; green-yellow, blue, gray

[www.wago.com/2020-210/000-039](http://www.wago.com/2020-210/000-039)



**Item no.: 2020-211**  
2-conductor female connector; 1.5 mm<sup>2</sup>; 11-pole; 1,50 mm<sup>2</sup>; gray

[www.wago.com/2020-211](http://www.wago.com/2020-211)



**Item no.: 2020-211/000-036**  
2-conductor female connector; 1.5 mm<sup>2</sup>; 11-pole; 1,50 mm<sup>2</sup>; gray, green-yellow

[www.wago.com/2020-211/000-036](http://www.wago.com/2020-211/000-036)



**Item no.: 2020-211/000-037**  
2-conductor female connector; 1.5 mm<sup>2</sup>; 11-pole; 1,50 mm<sup>2</sup>; green-yellow, gray

[www.wago.com/2020-211/000-037](http://www.wago.com/2020-211/000-037)



**Item no.: 2020-211/000-038**  
2-conductor female connector; 1.5 mm<sup>2</sup>; 11-pole; 1,50 mm<sup>2</sup>; gray, blue, green-yellow

[www.wago.com/2020-211/000-038](http://www.wago.com/2020-211/000-038)



**Item no.: 2020-211/000-039**  
2-conductor female connector; 1.5 mm<sup>2</sup>; 11-pole; 1,50 mm<sup>2</sup>; green-yellow, blue, gray

[www.wago.com/2020-211/000-039](http://www.wago.com/2020-211/000-039)



**Item no.: 2020-212**  
2-conductor female connector; 1.5 mm<sup>2</sup>; 12-pole; 1,50 mm<sup>2</sup>; gray

[www.wago.com/2020-212](http://www.wago.com/2020-212)



**Item no.: 2020-212/000-036**  
2-conductor female connector; 1.5 mm<sup>2</sup>; 12-pole; 1,50 mm<sup>2</sup>; gray, green-yellow

[www.wago.com/2020-212/000-036](http://www.wago.com/2020-212/000-036)



**Item no.: 2020-212/000-037**  
2-conductor female connector; 1.5 mm<sup>2</sup>; 12-pole; 1,50 mm<sup>2</sup>; green-yellow, gray

[www.wago.com/2020-212/000-037](http://www.wago.com/2020-212/000-037)



**Item no.: 2020-212/000-038**  
2-conductor female connector; 1.5 mm<sup>2</sup>; 12-pole; 1,50 mm<sup>2</sup>; gray, blue, green-yellow















[www.wago.com/2020-212/000-038](http://www.wago.com/2020-212/000-038)



**Item no.: 2020-212/000-039**  
2-conductor female connector; 1.5 mm<sup>2</sup>; 12-pole; 1,50 mm<sup>2</sup>; green-yellow, blue, gray

[www.wago.com/2020-212/000-039](http://www.wago.com/2020-212/000-039)

Subject to changes. Please also observe the further product documentation!

	<b>Item no.: 2020-213</b> 2-conductor female connector; 1.5 mm <sup>2</sup> ; 13-pole; 1,50 mm <sup>2</sup> ; gray	<a href="http://www.wago.com/2020-213">www.wago.com/2020-213</a>
	<b>Item no.: 2020-213/000-036</b> 2-conductor female connector; 1.5 mm <sup>2</sup> ; 13-pole; 1,50 mm <sup>2</sup> ; gray, green-yellow	<a href="http://www.wago.com/2020-213/000-036">www.wago.com/2020-213/000-036</a>
	<b>Item no.: 2020-213/000-037</b> 2-conductor female connector; 1.5 mm <sup>2</sup> ; 13-pole; 1,50 mm <sup>2</sup> ; green-yellow, gray	<a href="http://www.wago.com/2020-213/000-037">www.wago.com/2020-213/000-037</a>
	<b>Item no.: 2020-213/000-038</b> 2-conductor female connector; 1.5 mm <sup>2</sup> ; 13-pole; 1,50 mm <sup>2</sup> ; gray, blue, green-yellow	<a href="http://www.wago.com/2020-213/000-038">www.wago.com/2020-213/000-038</a>
	<b>Item no.: 2020-213/000-039</b> 2-conductor female connector; 1.5 mm <sup>2</sup> ; 13-pole; 1,50 mm <sup>2</sup> ; green-yellow, blue, gray	<a href="http://www.wago.com/2020-213/000-039">www.wago.com/2020-213/000-039</a>
	<b>Item no.: 2020-214</b> 2-conductor female connector; 1.5 mm <sup>2</sup> ; 14-pole; 1,50 mm <sup>2</sup> ; gray	<a href="http://www.wago.com/2020-214">www.wago.com/2020-214</a>
	<b>Item no.: 2020-214/000-036</b> 2-conductor female connector; 1.5 mm <sup>2</sup> ; 14-pole; 1,50 mm <sup>2</sup> ; gray, green-yellow	<a href="http://www.wago.com/2020-214/000-036">www.wago.com/2020-214/000-036</a>
	<b>Item no.: 2020-214/000-037</b> 2-conductor female connector; 1.5 mm <sup>2</sup> ; 14-pole; 1,50 mm <sup>2</sup> ; green-yellow, gray	<a href="http://www.wago.com/2020-214/000-037">www.wago.com/2020-214/000-037</a>
	<b>Item no.: 2020-214/000-038</b> 2-conductor female connector; 1.5 mm <sup>2</sup> ; 14-pole; 1,50 mm <sup>2</sup> ; gray, blue, green-yellow	<a href="http://www.wago.com/2020-214/000-038">www.wago.com/2020-214/000-038</a>
	<b>Item no.: 2020-214/000-039</b> 2-conductor female connector; 1.5 mm <sup>2</sup> ; 14-pole; 1,50 mm <sup>2</sup> ; green-yellow, blue, gray	<a href="http://www.wago.com/2020-214/000-039">www.wago.com/2020-214/000-039</a>
	<b>Item no.: 2020-215</b> 2-conductor female connector; 1.5 mm <sup>2</sup> ; 15-pole; 1,50 mm <sup>2</sup> ; gray	<a href="http://www.wago.com/2020-215">www.wago.com/2020-215</a>
	<b>Item no.: 2020-215/000-036</b> 2-conductor female connector; 1.5 mm <sup>2</sup> ; 15-pole; 1,50 mm <sup>2</sup> ; gray, green-yellow	<a href="http://www.wago.com/2020-215/000-036">www.wago.com/2020-215/000-036</a>
	<b>Item no.: 2020-215/000-037</b> 2-conductor female connector; 1.5 mm <sup>2</sup> ; 15-pole; 1,50 mm <sup>2</sup> ; green-yellow, gray	<a href="http://www.wago.com/2020-215/000-037">www.wago.com/2020-215/000-037</a>
	<b>Item no.: 2020-215/000-038</b> 2-conductor female connector; 1.5 mm <sup>2</sup> ; 15-pole; 1,50 mm <sup>2</sup> ; gray, blue, green-yellow	<a href="http://www.wago.com/2020-215/000-038">www.wago.com/2020-215/000-038</a>

Subject to changes. Please also observe the further product documentation!



**Item no.: 2020-215/000-039**  
2-conductor female connector; 1.5 mm<sup>2</sup>; 15-pole; 1,50 mm<sup>2</sup>; green-yellow, blue, gray

[www.wago.com/2020-215/000-039](http://www.wago.com/2020-215/000-039)



**Item no.: 2020-261**  
Start module for 2-conductor female connector; with integrated end plate; 1.5 mm<sup>2</sup>; 1-pole; 1,50 mm<sup>2</sup>; gray

[www.wago.com/2020-261](http://www.wago.com/2020-261)



**Item no.: 2020-264**  
Start module for 2-conductor female connector; with integrated end plate; 1.5 mm<sup>2</sup>; 1-pole; 1,50 mm<sup>2</sup>; blue

[www.wago.com/2020-264](http://www.wago.com/2020-264)



**Item no.: 2020-267**  
Start module for 2-conductor female connector; 1.5 mm<sup>2</sup>; 1-pole; 1,50 mm<sup>2</sup>; green-yellow

[www.wago.com/2020-267](http://www.wago.com/2020-267)



**Item no.: 2020-281**  
End module for 2-conductor female connector; 1.5 mm<sup>2</sup>; 1-pole; 1,50 mm<sup>2</sup>; gray

[www.wago.com/2020-281](http://www.wago.com/2020-281)



**Item no.: 2020-284**  
End module for 2-conductor female connector; 1.5 mm<sup>2</sup>; 1-pole; 1,50 mm<sup>2</sup>; blue

[www.wago.com/2020-284](http://www.wago.com/2020-284)



**Item no.: 2020-287**  
End module for 2-conductor female connector; 1.5 mm<sup>2</sup>; 1-pole; 1,50 mm<sup>2</sup>; green-yellow

[www.wago.com/2020-287](http://www.wago.com/2020-287)

#### Jumper



**Item no.: 2000-402**  
Jumper; 2-way; insulated; light gray

[www.wago.com/2000-402](http://www.wago.com/2000-402)



**Item no.: 2000-402/000-005**  
Jumper; 2-way; insulated; red

[www.wago.com/2000-402/000-005](http://www.wago.com/2000-402/000-005)



**Item no.: 2000-402/000-006**  
Jumper; 2-way; insulated; blue

[www.wago.com/2000-402/000-006](http://www.wago.com/2000-402/000-006)



**Item no.: 2000-402/000-018**  
Jumper; 2-way; insulated; yellow-green

[www.wago.com/2000-402/000-018](http://www.wago.com/2000-402/000-018)



**Item no.: 2000-403**  
Jumper; 3-way; insulated; light gray

[www.wago.com/2000-403](http://www.wago.com/2000-403)



**Item no.: 2000-403/000-005**  
Jumper; 3-way; insulated; red

[www.wago.com/2000-403/000-005](http://www.wago.com/2000-403/000-005)



**Item no.: 2000-403/000-006**  
Jumper; 3-way; insulated; blue

[www.wago.com/2000-403/000-006](http://www.wago.com/2000-403/000-006)



**Item no.: 2000-404**  
Jumper; 4-way; insulated; light gray

[www.wago.com/2000-404](http://www.wago.com/2000-404)

Subject to changes. Please also observe the further product documentation!

WAGO Kontakttechnik GmbH & Co. KG

Hansastr. 27















32423 Minden

Phone: +49571 887-0 | Fax: +49571 887-169















Email: [info.de@wago.com](mailto:info.de@wago.com) | Web: [www.wago.com](http://www.wago.com)

Do you have any questions about our products?

We are always happy to take your call at +49 (571) 887-44222.

	<p><b>Item no.: 2000-404/000-005</b>                      Jumper; 4-way; insulated; red</p>	<a href="http://www.wago.com/2000-404/000-005">www.wago.com/2000-404/000-005</a>
	<p><b>Item no.: 2000-404/000-006</b>                      Jumper; 4-way; insulated; blue</p>	<a href="http://www.wago.com/2000-404/000-006">www.wago.com/2000-404/000-006</a>
	<p><b>Item no.: 2000-405</b>                      Jumper; 5-way; insulated; light gray</p>	<a href="http://www.wago.com/2000-405">www.wago.com/2000-405</a>
	<p><b>Item no.: 2000-405/000-005</b>                      Jumper; 5-way; insulated; red</p>	<a href="http://www.wago.com/2000-405/000-005">www.wago.com/2000-405/000-005</a>
	<p><b>Item no.: 2000-405/000-006</b>                      Jumper; 5-way; insulated; blue</p>	<a href="http://www.wago.com/2000-405/000-006">www.wago.com/2000-405/000-006</a>
	<p><b>Item no.: 2000-405/011-000</b>                      Star point jumper; 3-way; insulated; light gray</p>	<a href="http://www.wago.com/2000-405/011-000">www.wago.com/2000-405/011-000</a>
	<p><b>Item no.: 2000-406</b>                      Jumper; 6-way; insulated; light gray</p>	<a href="http://www.wago.com/2000-406">www.wago.com/2000-406</a>
	<p><b>Item no.: 2000-406/000-005</b>                      Jumper; 6-way; insulated; red</p>	<a href="http://www.wago.com/2000-406/000-005">www.wago.com/2000-406/000-005</a>
	<p><b>Item no.: 2000-406/000-006</b>                      Jumper; 6-way; insulated; blue</p>	<a href="http://www.wago.com/2000-406/000-006">www.wago.com/2000-406/000-006</a>
	<p><b>Item no.: 2000-406/020-000</b>                      Delta jumper; insulated; light gray</p>	<a href="http://www.wago.com/2000-406/020-000">www.wago.com/2000-406/020-000</a>
	<p><b>Item no.: 2000-407</b>                      Jumper; 7-way; insulated; light gray</p>	<a href="http://www.wago.com/2000-407">www.wago.com/2000-407</a>
	<p><b>Item no.: 2000-407/000-005</b>                      Jumper; 7-way; insulated; red</p>	<a href="http://www.wago.com/2000-407/000-005">www.wago.com/2000-407/000-005</a>
	<p><b>Item no.: 2000-407/000-006</b>                      Jumper; 7-way; insulated; blue</p>	<a href="http://www.wago.com/2000-407/000-006">www.wago.com/2000-407/000-006</a>
	<p><b>Item no.: 2000-408</b>                      Jumper; 8-way; insulated; light gray</p>	<a href="http://www.wago.com/2000-408">www.wago.com/2000-408</a>

Subject to changes. Please also observe the further product documentation!

	<b>Item no.: 2000-408/000-005</b> Jumper; 8-way; insulated; red	<a href="http://www.wago.com/2000-408/000-005">www.wago.com/2000-408/000-005</a>
	<b>Item no.: 2000-408/000-006</b> Jumper; 8-way; insulated; blue	<a href="http://www.wago.com/2000-408/000-006">www.wago.com/2000-408/000-006</a>
	<b>Item no.: 2000-409</b> Jumper; 9-way; insulated; light gray	<a href="http://www.wago.com/2000-409">www.wago.com/2000-409</a>
	<b>Item no.: 2000-409/000-005</b> Jumper; 9-way; insulated; red	<a href="http://www.wago.com/2000-409/000-005">www.wago.com/2000-409/000-005</a>
	<b>Item no.: 2000-409/000-006</b> Jumper; 9-way; insulated; blue	<a href="http://www.wago.com/2000-409/000-006">www.wago.com/2000-409/000-006</a>
	<b>Item no.: 2000-410</b> Jumper; 10-way; insulated; light gray	<a href="http://www.wago.com/2000-410">www.wago.com/2000-410</a>
	<b>Item no.: 2000-410/000-005</b> Jumper; 10-way; insulated; red	<a href="http://www.wago.com/2000-410/000-005">www.wago.com/2000-410/000-005</a>
	<b>Item no.: 2000-410/000-006</b> Jumper; 10-way; insulated; blue	<a href="http://www.wago.com/2000-410/000-006">www.wago.com/2000-410/000-006</a>
	<b>Item no.: 2000-433</b> Jumper; from 1 to 3; insulated; light gray	<a href="http://www.wago.com/2000-433">www.wago.com/2000-433</a>
	<b>Item no.: 2000-433/000-005</b> Jumper; from 1 to 3; insulated; red	<a href="http://www.wago.com/2000-433/000-005">www.wago.com/2000-433/000-005</a>
	<b>Item no.: 2000-433/000-006</b> Jumper; from 1 to 3; insulated; blue	<a href="http://www.wago.com/2000-433/000-006">www.wago.com/2000-433/000-006</a>
	<b>Item no.: 2000-434</b> Jumper; from 1 to 4; insulated; light gray	<a href="http://www.wago.com/2000-434">www.wago.com/2000-434</a>
	<b>Item no.: 2000-435</b> Jumper; from 1 to 5; insulated; light gray	<a href="http://www.wago.com/2000-435">www.wago.com/2000-435</a>
	<b>Item no.: 2000-436</b> Jumper; from 1 to 6; insulated; light gray	<a href="http://www.wago.com/2000-436">www.wago.com/2000-436</a>
	<b>Item no.: 2000-437</b> Jumper; from 1 to 7; insulated; light gray	<a href="http://www.wago.com/2000-437">www.wago.com/2000-437</a>

Subject to changes. Please also observe the further product documentation!



**Item no.: 2000-438**  
Jumper; from 1 to 8; insulated; light gray

[www.wago.com/2000-438](http://www.wago.com/2000-438)



**Item no.: 2000-439**  
Jumper; from 1 to 9; insulated; light gray

[www.wago.com/2000-439](http://www.wago.com/2000-439)



**Item no.: 2000-440**  
Jumper; from 1 to 10; insulated; light gray

[www.wago.com/2000-440](http://www.wago.com/2000-440)



**Item no.: 210-103**  
Wire commoning chain; insulated; black

[www.wago.com/210-103](http://www.wago.com/210-103)



**Item no.: 210-123**  
Wire commoning chain; insulated; blue

[www.wago.com/210-123](http://www.wago.com/210-123)

## Downloads

### Documentation

#### Bid Text

2020-5377/102-000 docx - Datei	7. 8. 2018	docx 15.5 kB	Download
-----------------------------------	------------	-----------------	----------

2020-5377/102-000 X81 - Datei	19. 2. 2019	xml 4.3 kB	Download
----------------------------------	-------------	---------------	----------

#### Additional Information

Technical explanations	3. 4. 2019	pdf 2.2 MB	Download
------------------------	------------	---------------	----------

## CAD/CAE-Data

### CAD data

2D/3D Models 2020-5377/102-000		URL	Download
--------------------------------	--	-----	----------

### CAE data

ZUKEN Portal 2020-5377/102-000		URL	Download
--------------------------------	--	-----	----------

## Environmental Product Compliance

### Compliance Search

Environmental Product Compliance 2020-5377/102-000		URL	Download
--	--	-----	----------

Subject to changes. Please also observe the further product documentation!

3-conductor sensor/actuator terminal block; for PNP-(high-side) switching actuators;  
with ground contact; 1 mm<sup>2</sup>; Push-in CAGE CLAMP®; 1,00 mm<sup>2</sup>; orange

## Installation Notes

### Installation

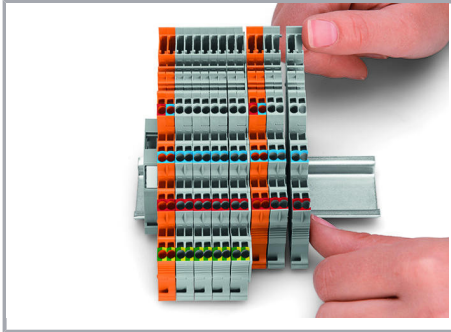

Snap individual terminal blocks onto the DIN-rail and slide together.

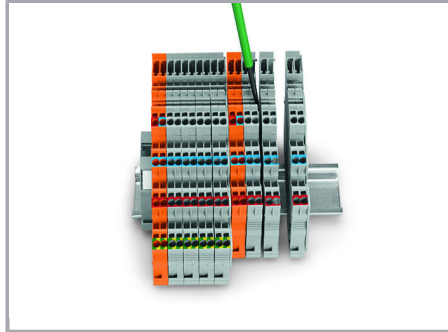

Separate terminal block assembly and slide individual terminal blocks laterally using an operating tool.

### Testing

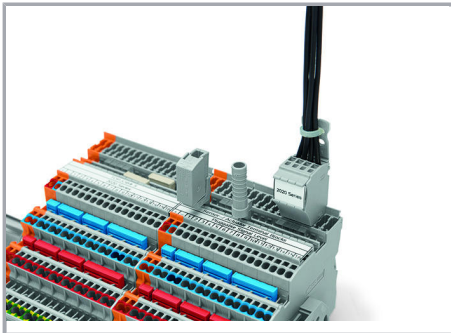

Testing via testing tap (2009-182) or test plug adapter (2009-174) (up to max. 42 V).

### Coding

Subject to changes. Please also observe the further product documentation!



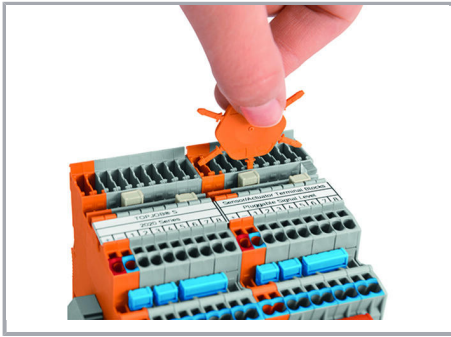

Insert coding pin into the corresponding slot and twist it off.

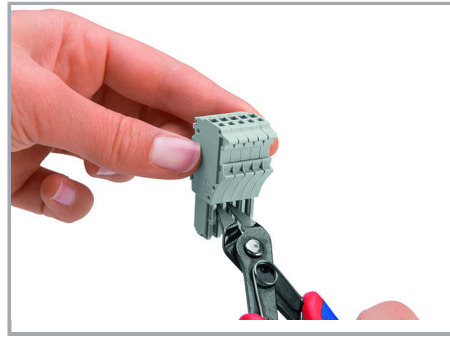

Remove the coding finger using a cutting tool.

### Locking system

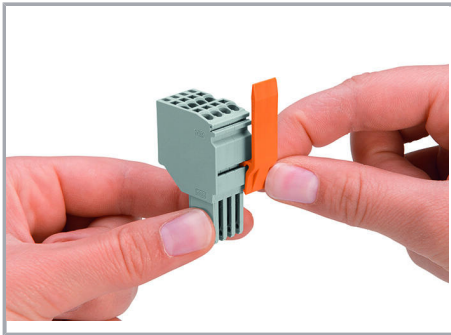

Slide the locking lever into position.

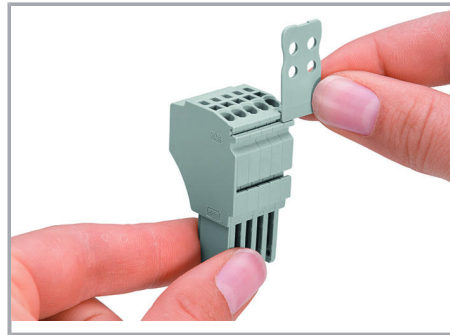

### Strain relief

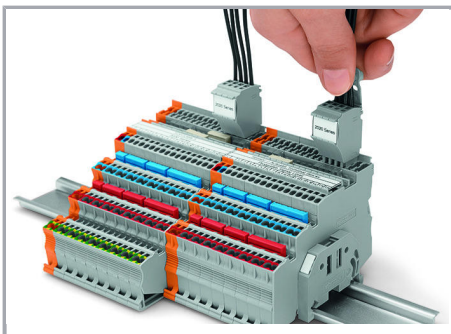

Removing a female plug via conductor bundle provided with strain relief plate.

### Marking

Subject to changes. Please also observe the further product documentation!

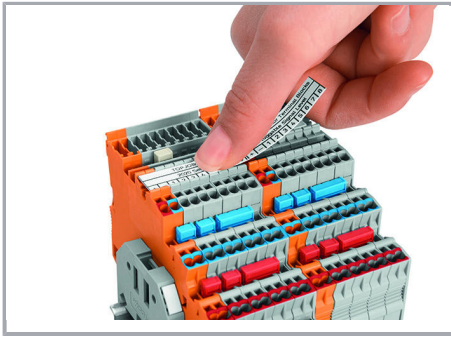

Labeling terminal blocks via marking strips (2009-110) or 3.5 mm wide WMB markers (793-35xx) – from the top or the side.

## Product family

### TOPJOB® S

TOPJOB® S: In various industrial applications and modern building installations, WAGO's wide and versatile range of rail-mount terminal blocks provides more than just reliable electrical connections.

[Show all products from the family](#)

Subject to changes. Please also observe the further product documentation!