

POWER RELAY

1 POLE - 10A Relay Type

FTR-H2 Series

■ FEATURES

- High density mounting
Saves space by 26% compared to FTR-H1 type
- High insulation
Insulation distance: minimum 6mm between coil and contact
Dielectric strength: 4KV
Surge strength: 10KV
- TV-5 rating
- Heat resistance, flammability
Class B (130° C) wire class, flammability 94V-0
- Cadmium free contact for eco-program
- Safety standards
UL, CSA, VDE approved
UL/CSA TV-5 rating approved
- Flux proof relay, RT II
- RoHS compliant
Please see page 6 for more information



■ PARTNUMBER INFORMATION

[Example] $\frac{\text{FTR-H2}}{\text{(a)}}$ $\frac{\text{A}}{\text{(b)}}$ $\frac{\text{K}}{\text{(c)}}$ $\frac{\text{012}}{\text{(d)}}$ $\frac{\text{T}}{\text{(e)}}$

(a)	Relay type	FTR-H2	: FTR-H2-Series
(b)	Contact configuration	A	: 1 form A (SPST-NO)
(c)	Coil type / enclosure	K L	: Standard type (530mW) : High sensitive type (250mW)
(d)	Coil rated voltage	012	: 5.....48 VDC Coil rating table at page 3
(e)	Contact material / TV type	T	: Silver-tin oxide / TV-5

Actual marking does not carry the type name : "FTR"
E.g.: Ordering code: FTR-H2AK012T Actual marking: H2AK012T

FTR-H2 SERIES

■ SPECIFICATION

Item			H2 AK () T	H2 AL () T
Contact Data	Configuration		1 form A (SPST-NO)	
	Construction		Single	
	Material		Silver tin oxide (AgSnO ₂)	
	Resistance (initial)		Max. 100mΩ at 6VDC, 1A	
	Contact rating		250VAC / 30VDC ,10A	
	Max. carrying current		10A	
	Max. inrush current		78A 250VAC	
	Max. switching voltage		400VAC / 300VDC	
	Max. switching power		2,500VA / 300W	
	Min. switching load*		100mA, 5VDC	
Life	Mechanical		Min. 2 x 10 ⁶ operations	
	Electrical	AC contact rating	Min. 100 x 10 ³ operations	
		DC contact rating	Min. 100 x 10 ³ operations	
		Lamp load (TV-5)	Min. 25 x 10 ³ operations	
Coil Data	Rated Power (20 °C)		530mW	250mW
	Operate Power (20 °C)		260mW	160mW
	Operating temperature range		-40 °C to +70 °C (no frost)	
Timing Data	Operate		Max. 15ms (without bounce)	
	Release		Max. 5ms (without bounce)	
Insulation	Resistance (Initial)		Min. 1,000MΩ at 500VDC	
	Dielectric strength	Open contacts	1,000VAC (50/60Hz) 1min	
		Contacts to coil	4,000VAC (50/60Hz) 1min	
	Surge strength	Coil to contacts	10,000V / 1.2 x 50μs standard wave	
	Clearance		6mm	
	Creepage		6mm	
	DIN EN61810-1, VDE0435	Voltage	250V	
		Pollution degree	2	
		Material group	III	
	Category	B / 250V		
Other	Vibration resistance	Misoperation>1us	10 to 55 to 10 single amplitude 0.75mm	
		Endurance	10 to 55 to 10 single amplitude 0.75mm	
	Shock	Misoperation>1us	Min. 200m/s ² (11 ± 1ms)	
		Endurance	Min. 1,000m/s ² (6 ± 1ms)	
	Weight		Approximately 13g	
	Sealing		Flux proof RTII	

* Minimum switching loads mentioned above are reference values. Please perform the confirmation test with actual load before production since reference values may vary according to switching frequencies, environmental conditions and expected reliability levels.

■ COIL RATING

Standard type (530 mW)

Coil Code	Rated Coil Voltage (VDC)	Coil Resistance +/- 10% (Ohm)	Must Operate Voltage (VDC) *	Must Release-Voltage (VDC) *	Rated Power (mW)
005	5	47	3.5	0.25	530
006	6	68	4.2	0.3	
009	9	155	6.3	0.45	
012	12	270	8.4	0.6	
018	18	610	12.6	0.9	
024	24	1,110	16.8	1.2	
048	48	4,400	33.6	2.4	

High sensitive type (400 mW)

Coil Code	Rated Coil Voltage (VDC)	Coil Resistance +/- 10% (Ohm)	Must Operate Voltage (VDC) *	Must Release-Voltage (VDC) *	Rated Power (mW)
005	5	100	4	0.25	250
006	6	145	4.8	0.3	
009	9	325	7.2	0.45	
012	12	575	9.6	0.6	
015	15	900	12	0.75	
024	24	2,310	19.2	1.2	

Note: All values in the table are valid for 20°C and zero contact current.

* Specified operate values are measured by pulse wave voltage.

Please use at rated coil voltage. Please refer to characteristic data and set up adequate voltage in case of use at over voltage.

■ SAFETY STANDARDS

Type	Compliance	Contact rating
UL	UL 508	Flammability: UL 94-V0 (plastics)
	E63614	10A, 250VAC/30VDC (resistive) 15A, 125VAC (resistive) (UL)
CSA	C22.2 No. 14 LR 40304	1/6 hp, 125VAC 1/2 hp, 250VAC TV-5, 120 VAC/240VAC Pilot duty: C300
VDE	IEC/EN61810-1, EN60065 clause 14.6.1 40014652	10A, 250 VAC (cosφ=1) 3A, 250 VAC (cosφ=0.4) 10A, 30 VDC (0ms) 5/80A, 250VAC
CQC	GB/T21711.1, GB15092.1 03001005579	10A 250VAC

CHARACTERISTIC DATA (Reference)

(Characteristic data is not guaranteed value but measured values of samples from production line.)

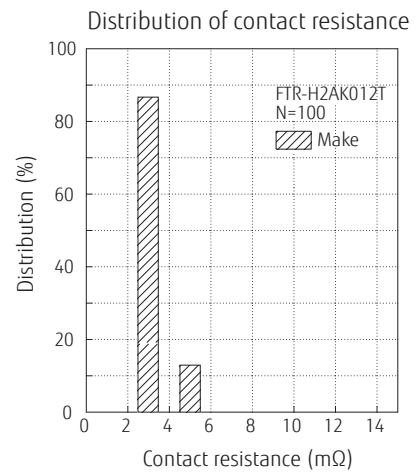
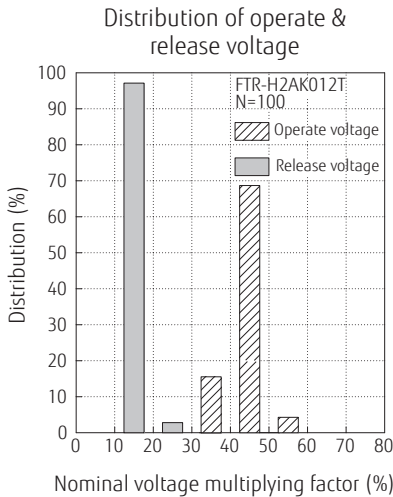
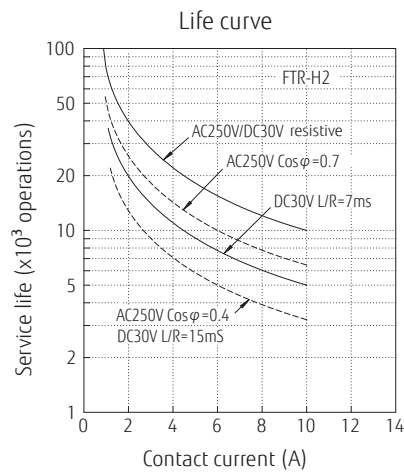
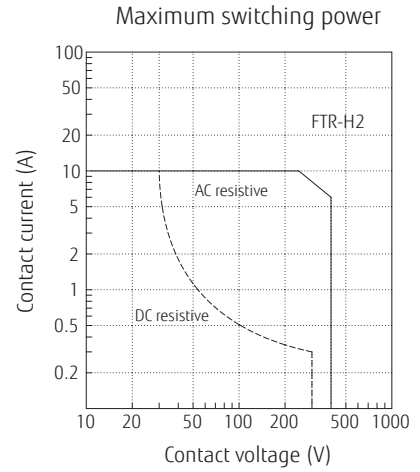
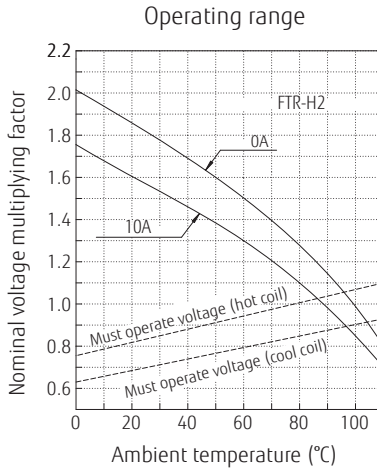
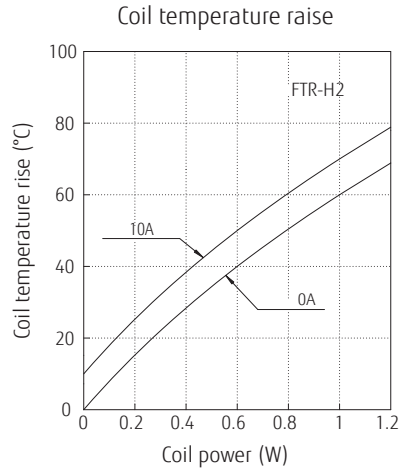

■ DIMENSIONS

● Dimensions

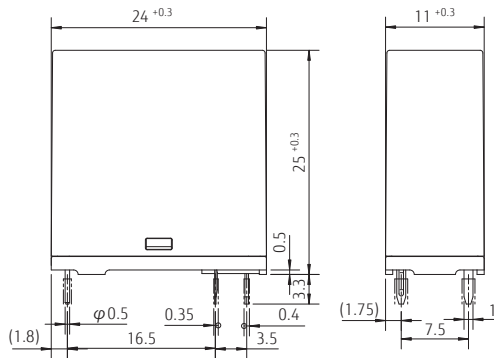

● Schematics

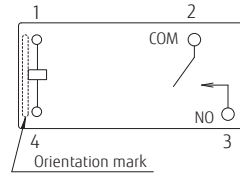

● PC board mounting hole layout (BOTTOM VIEW)

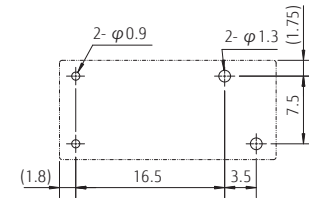

Tolerance of PC board mounting hole layout : ± 0.1 unless otherwise specified.

Unit: mm

Cautions

- All values mentioned in this datasheet are provided under ideal conditions. Please perform the confirmation test before actual use.
- Reflow soldering is prohibited.
- Do not use relays in the atmosphere with sulfide gas, chloride gas or nitric oxide. Contact resistance may increase.
- Do not use silicon or silicon-containing product or materials near relays. It may cause contact failure.

RoHS Compliance and Lead Free Information

1. General Information

- All relays produced by Fujitsu Components are compliant with RoHS directive 2011/65/EU including amendments.
- Cadmium as used in electrical contacts is exempted from the RoHS directives. As per Annex III of directive 2011/65/EU.
- All relays are lead-free. Please refer to Lead-Free Status Info for older date codes at: <http://www.fujitsu.com/downloads/MICRO/fcai/relays/lead-free-letter.pdf>
- Lead free solder plating on relay terminals is Sn-3.0Ag-0.5Cu, unless otherwise specified. This material has been verified to be compatible with PbSn assembly process.

2. Recommended Lead Free Solder Condition

- Recommended solder Sn-3.0Ag-0.5Cu.

Flow Solder Condition:

Pre-heating: maximum 120 °C
within 90 sec.
Soldering: dip within 5 sec. at
255 °C ± 5 °C solder bath
Relay must be cooled by air immediately
after soldering

Solder by Soldering Iron:

Soldering Iron 30-60W
Temperature: maximum 350-360 °C
Duration: maximum 3 sec.

We highly recommend that you confirm your actual solder conditions

3. Moisture Sensitivity

- Moisture Sensitivity Level standard is not applicable to electromechanical relays, unless otherwise indicated.

4. Tin Whiskers

- Dipped SnAgCu solder is known as presenting a low risk to tin whisker development. No considerable length whisker was found by our in house test.

Fujitsu Components International Headquarter Offices

Japan FUJITSU COMPONENT LIMITED Shinagawa Seaside Park Tower 19F, 12-4, Higashi-shinagawa 4-chome, Shinagawa-ku, Tokyo, 140-0002, Japan Tel: (81-3) 3450-1682 Fax: (81-3) 3474-2385 Email: fcl-contact@cs.jp.fujitsu.com Web: www.fujitsu.com/jp/fcl/	Asia Pacific FUJITSU COMPONENTS ASIA, LTD. 102E Pasir Panjang Road #01-01 Citilink Warehouse Complex Singapore 118529 Tel: (65) 6375-8560 Fax: (65) 6273-3021 Email: fcal@sg.fujitsu.com Web: www.fujitsu.com/sg/products/devices/components	Korea FUJITSU COMPONENTS KOREA LIMITED Alpha Tower #403, 645 Sampyeong-dong, Bundang-gu, Seongnam-si, Gyeonggi-do, 13524 Korea Tel: (82) 31-708-7108 Fax: (82) 31-709-7108 Email: fcal@sg.fujitsu.com www.fujitsu.com/sg/products/devices/components/
North and South America FUJITSU COMPONENTS AMERICA, INC 2290 North First Street, Suite 212 San Jose, CA 95131, USA Tel: (1-408) 745-4900 Fax: (1-408) 745-4970 Email: components@us.fujitsu.com Web: us.fujitsu.com/components	China FUJITSU ELECTRONIC COMPONENTS (SHANGHAI) CO., LTD. Unit 4306, InterContinental Center 100 Yu Tong Road, Shanghai 200070, China Tel: (86-21) 3253 0998 Fax: (86-21) 3253 0997 Email: fcal@sg.fujitsu.com Web: www.fujitsu.com/sg/products/devices/components	
Europe FUJITSU COMPONENTS EUROPE B.V. Diamantlaan 25 2132 WV Hoofddorp Netherlands Tel: (31-23) 5560910 Fax: (31-23) 5560950 Email: info@fceu.fujitsu.com Web: www.fujitsu.com/uk/components	Hong Kong FUJITSU COMPONENTS HONG KONG CO., LTD Unit 506, Inter-Continental Plaza No.94 Granville Road, Tsim Sha Tsui, Kowloon, Hong Kong Tel: (852) 2881-8495 Tex: (852) 2894-9512 Email: fcal@sg.fujitsu.com Web: www.fujitsu.com/sg/products/devices/components/	

©2017 Fujitsu Components Europe B.V. All rights reserved. All trademarks or registered trademarks are the property of their respective owners.

The contents, data and information in this datasheet are provided by Fujitsu Component Ltd. as a service only to its user and only for general information purposes.

The use of the contents, data and information provided in this datasheet is at the users' own risk.

Fujitsu has assembled this datasheet with care and will endeavor to keep the contents, data and information correct, accurate, comprehensive, complete and up to date.

Fujitsu Components Europe B.V. and affiliated companies do however not accept any responsibility or liability on their behalf, nor on behalf of its employees, for any loss or damage, direct, indirect or consequential, with respect to this datasheet, its contents, data, and information and related graphics and the correctness, reliability, accuracy, comprehensiveness, usefulness, availability and completeness thereof.

Nor do Fujitsu Components Europe B.V. and affiliated companies accept on their behalf, nor on behalf of its employees, any responsibility or liability for any representation or warrant of any kind, express or implied, including warranties of any kind for merchantability or fitness for particular use, with respect to these datasheets, its contents, data, information and related graphics and the correctness, reliability, accuracy, comprehensiveness, usefulness, availability and completeness thereof. Rev. August 17th, 2017