

Overall length when mated

Item description

- Set: Socket 890-202 and strain relief housing 890-502/342-000
- Protected against mismatching and maintenance-free
- Push-in CAGE CLAMP® spring pressure connection technology allows solid conductors to be simply pushed into a unit
- Compact design with 4.4 mm pole spacing
- When assembled the installation connectors complies with IP40 and are suitable for easily accessible areas

Subject to changes. Please also observe the further product documentation!



Data

Electrical data

Note on contact resistance	approx. 1 mΩ of contact resistance approx. 0.25 mΩ contact transition plug/socket
----------------------------	-----------------------------------------------------------------------------------

Ratings per IEC/EN

Ratings per	IEC/EN 60664-1
Nominal voltage (III/3)	250 V
Rated surge voltage (III/3)	4 kV
Rated current	16 A
Legend (ratings)	(III / 3) ≙ Overvoltage category III / Pollution degree 3

Ratings per UL

Hinweis für den amerikanischen Markt	Application note for the U.S. market (USR): Some versions may also be used for current interruption in accordance with the UL certificate in select applications with currents below 5 A and voltages up to 600 V. For further information, please contact your local sales office.
--------------------------------------	-------------------------------------------------------------------------------------------------------------------------------------------------------------------------------------------------------------------------------------------------------------------------------------

Rated voltage UL 1977	600 V
Rated current UL 1977	14 A

Connection data

Connection technology	Push-in CAGE CLAMP®
Actuation type	Operating tool Push-in
Nominal cross-section	1.5 mm ²
Solid conductor	0.25 ... 1.5 mm ² / 22 ... 16 AWG
Solid conductor; push-in termination	0.75 ... 1.5 mm ² / 20 ... 16 AWG
Stranded conductor	0.25 ... 1 mm ² / 22 ... 18 AWG
Fine-stranded conductor	0.25 ... 1.5 mm ² / 22 ... 16 AWG
Fine-stranded conductor; with insulated ferrule	0.25 ... 0.75 mm ² / 22 ... 20 AWG
Fine-stranded conductor; with uninsulated ferrule	0.25 ... 0.75 mm ² / 22 ... 20 AWG
Fine-stranded conductor; with ferrule; push-in termination	0.75 mm ² / 20 AWG
Strip length	9 mm / 0.35 inch
Note (strip length)	see also packaging or instructions
Pole No.	2

Subject to changes. Please also observe the further product documentation!

WAGO Kontakttechnik GmbH & Co. KG
Hansastr. 27
32423 Minden
Phone: +49571 887-0 | Fax: +49571 887-169
Email: info.de@wago.com | Web: www.wago.com

Do you have any questions about our products?
We are always happy to take your call at +49 (571) 887-44222.



Total number of connection points	2
Total number of potentials	2
Connectable sheathed cable diameter	3.8 ... 8.2 mm
Conductor entry direction to mating direction	0°
Strip length (outer insulation)	17.5 mm

Physical data

Pin spacing	4.4 mm / 0.173 inch
Width	15.6 mm / 0.614 inch
Height	13.2 mm / 0.52 inch
Depth	46.5 mm / 1.831 inch

Mechanical data

Application	General mains applications
Coding	A
Marking	L N
Potential marking	L N
Mating force of a plug-in connection	approx. 20 ... 70 N (depending on pole number)
Retention force of a plug-in connection	Locked: > 80 N
Unmating force of a plug-in connection	Unlocked: approx. 20 ... 70 N (depending on pole number)
Number of mating cycles	200, without resistive load
Protection type	IP40

Plug-in connection

Contact type (pluggable connector)	Female connector/socket
Connector (connection type)	for conductor
Mismating protection	Yes
Note on mismating protection	All WINSTA [®] components are 100% protected against mismating when: a.) plugging different numbers of poles b.) plugging while rotated 180 c.) plugging while laterally staggered d.) plugging one pole
Locking lever	Can be retrofitted
Locking of plug-in connection	locking lever
Hinweis zur Verriegelung	All connectors for mounted installations (snap-in versions for lighting fixtures or devices, all types of PCB and distribution connectors) are factory-equipped with locking levers to ensure plugs and sockets are securely locked. Additional locking levers are only required for flying leads (plug/socket).

Subject to changes. Please also observe the further product documentation!

Strain relief	strain relief housing, short
---------------	------------------------------

Material data

Color	black
Insulation material	Polyamide (PA66)
Clamping spring material	Chrome nickel spring steel (CrNi)
Contact material	Copper or copper alloy (surface-treated)
Fire load	0.074 MJ
Weight	4.9 g

Environmental requirements

Processing temperature	-5 ... +40 °C
Continuous operating temperature	-35 ... +85 °C
Note on continuous operating temperature	Insulating parts for temperatures \leq 105 °C

Commercial data

Packaging type	BOX
Country of origin	DE
GTIN	4055143463652
Customs tariff number	85366990990

Approvals / Certificates

Ship Approvals

Logo	Approval	Additional Approval Text	Certificate name
	LR Lloyds Register	EN 61535	08/20047 (E2)

Counterpart



Item no.890-1606

T-distribution connector; 2-pole; Cod. A; 1 input; 2 outputs; 2 locking levers; black

www.wago.com/890-1606

Subject to changes. Please also observe the further product documentation!

WAGO Kontakttechnik GmbH & Co. KG

Hansastr. 27











32423 Minden

Phone: +49571 887-0 | Fax: +49571 887-169

Email: info.de@wago.com | Web: www.wago.com

Do you have any questions about our products?

We are always happy to take your call at +49 (571) 887-44222.

	Item no.890-112 Plug; with strain relief housing; 2-pole; 1,50 mm ² ; black	www.wago.com/890-112
	Item no.890-1615 T-distribution connector; 2-pole; Cod. A; 1 input; 2 outputs; 3 locking levers; for flying leads; black	www.wago.com/890-1615
	Item no.890-1636 h-distribution connector; 2-pole; Cod. A; 1 input; 2 outputs; outputs on one side; 3 locking levers; for flying leads; black	www.wago.com/890-1636
	Item no.890-1634 h-distribution connector; 2-pole; Cod. A; 1 input; 2 outputs; outputs on one side; 2 locking levers; black	www.wago.com/890-1634
	Item no.890-212 Plug; 2-pole; 1,50 mm ² ; black	www.wago.com/890-212
	Item no.890-212/342-000 Plug; with strain relief housing; 2-pole; 1,50 mm ² ; black	www.wago.com/890-212/342-000
	Item no.890-712 Snap-in plug; 2-pole; Cod. A; 1,50 mm ² ; black	www.wago.com/890-712
	Item no.890-812 Plug for PCBs; straight; 2-pole; Cod. A; black	www.wago.com/890-812
	Item no.891-8992/205-101 pre-assembled connecting cable; Eca; Plug/open-ended; 2-pole; Cod. A; H05VV-F 2 x 1.0 mm ² ; 1 m; 1,00 mm ² ; black	www.wago.com/891-8992/205-101
	Item no.890-812/011-000 Plug for PCBs; angled; 2-pole; Cod. A; black	www.wago.com/890-812/011-000
	Item no.891-8992/005-101 pre-assembled interconnecting cable; Eca; Socket/plug; 2-pole; Cod. A; H05VV-F 2 x 1.0 mm ² ; 1 m; 1,00 mm ² ; black	www.wago.com/891-8992/005-101







Required accessories

tools

	Item no.: 890-382 Operating tool; 2-way; green	www.wago.com/890-382
------------------------------------------------------------------------------------	----------------------------------------------------------	----------------------------------------------------------------

assembling

Subject to changes. Please also observe the further product documentation!

	Item no.: 890-310 Mounting carrier; 2- to 5-pole; for flying leads; black	www.wago.com/890-310
	Item no.: 890-311 Mounting carrier; 2- to 5-pole; for flying leads; white	www.wago.com/890-311
Locking lever		
	Item no.: 890-101 Locking lever; for manual operation; black	www.wago.com/890-101
	Item no.: 890-111 Locking lever; for flying leads; for tool operation; black	www.wago.com/890-111
	Item no.: 890-121 Locking lever; for manual operation; white	www.wago.com/890-121
	Item no.: 890-131 Locking lever; for flying leads; for tool operation; white	www.wago.com/890-131

Compatible products

tools

	Item no.: 210-719 Operating tool; Blade: 2.5 x 0.4 mm; with a partially insulated shaft	www.wago.com/210-719
----------------------------------------------------------------------------------	---------------------------------------------------------------------------------------------------	----------------------------------------------------------------

Downloads

Documentation

Bid Text

890-202/342-000 doc - Datei	13. 4. 2017	doc 24.1 kB	Download
890-202/342-000 X81 - Datei	19. 2. 2019	xml 3.1 kB	Download

Environmental Product Compliance

Compliance Search

Environmental Product Compliance 890-202/342-000 Socket; with strain relief housing; 2-pole; Cod. A; 1,50 mm ² ; black	URL	Download
--------------------------------------------------------------------------------------------------------------------------------------	-----	----------

Installation Notes

Subject to changes. Please also observe the further product documentation!

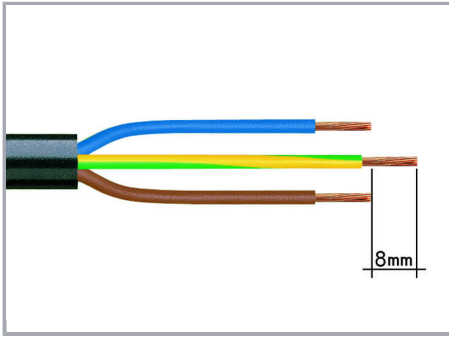

1. Strip length, outer insulation = 30 mm (2-pole), 37 mm (3-pole), 45 mm (4- and 5-pole)
2. Strip length = 9 mm
3. Extended ground conductor = 8 mm

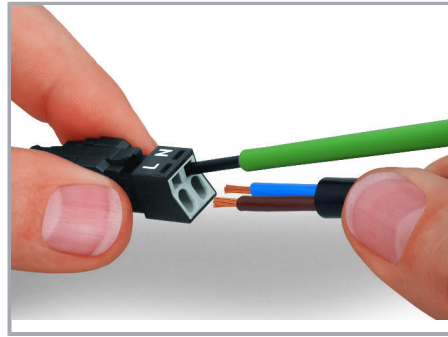

To terminate fine-stranded conductors, open the clamping unit via screwdriver – 2.5 mm blade width – and insert a stripped conductor until it hits the backstop. Terminate solid conductors by simply pushing them in.

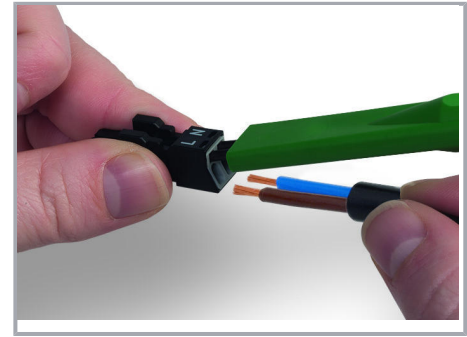

To terminate fine-stranded conductors, open clamping units via operating tool (890-382) and insert stripped conductors until they hit backstop.

Terminate solid conductors by simply pushing them in.

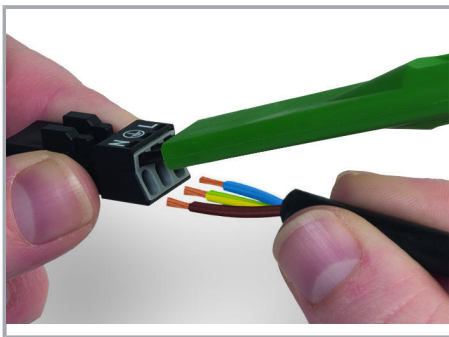

To terminate fine-stranded conductors, open clamping units via operating tool (890-383) and insert stripped conductors until they hit backstop.

Terminate solid conductors by simply pushing them in.

Installation

Subject to changes. Please also observe the further product documentation!

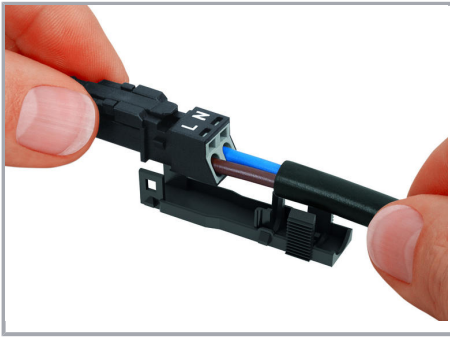

Latch the wired connector into the base of the strain relief housing.

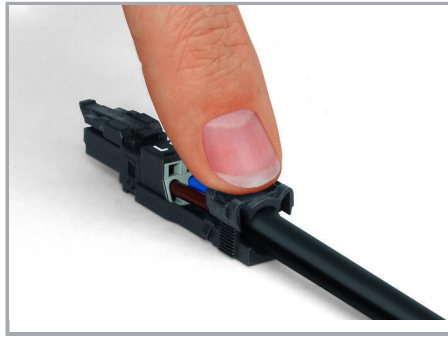

Push down strain relief clamp by hand.



Push down strain relief clamp with 2.5 mm screwdriver alternately on both sides.



Latch the top of the strain relief housing.

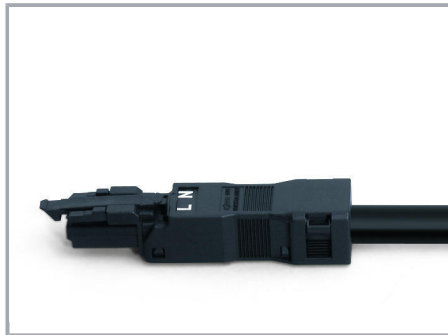

The printed marking of the connector is clearly visible in the openings of the strain relief housing.

Product family

WINSTA® MINI

[Show all products from the family](#)

Subject to changes. Please also observe the further product documentation!