

Top View of Assembly

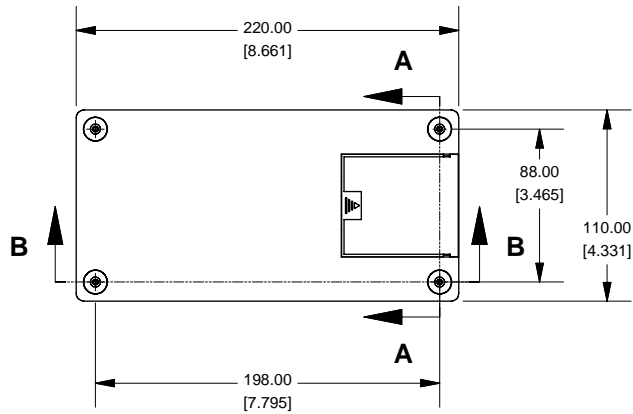

SECTION A-A End View of Assembly

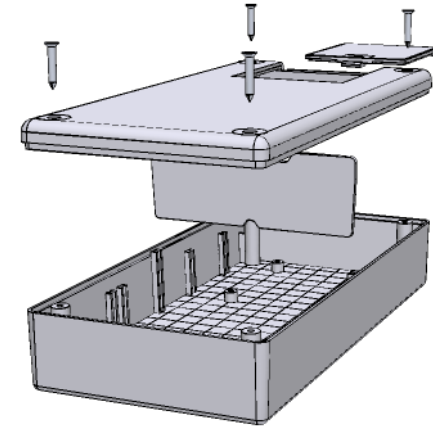
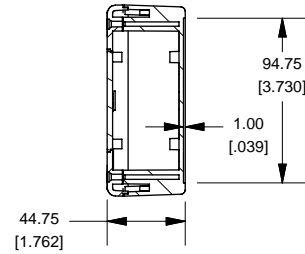

SECTION B-B Side View of Assembly

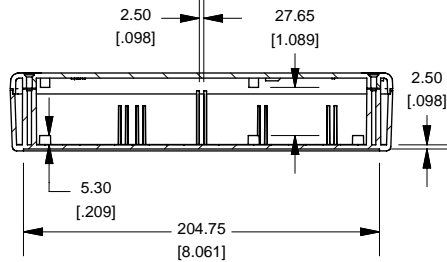

Top View Looking Inside Box

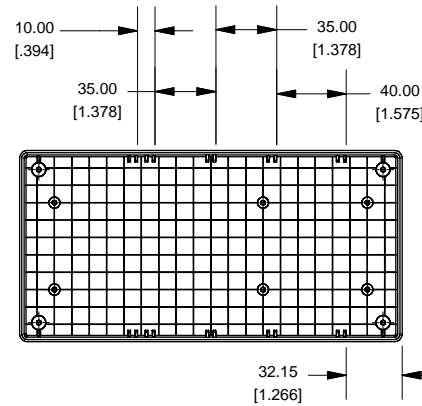

Lid

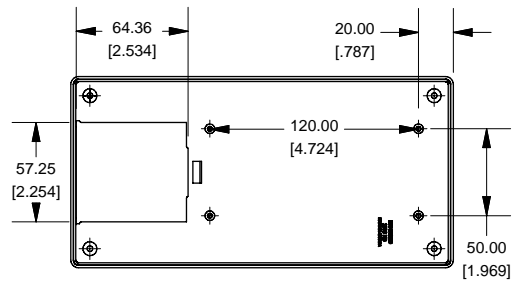

Divider

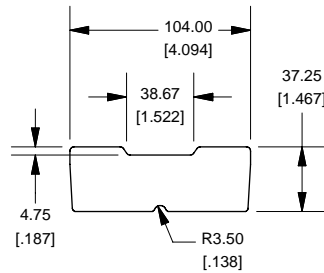

Maximum P.C. Board Size

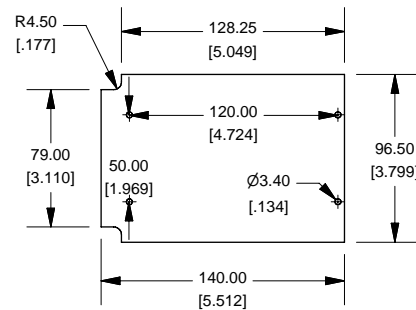

Enclosures can be Factory Modified (Milling, Drilling, Printing etc.)
 Contact Factory mjm@hammondmfg.com for quotes
 Solid models of this enclosure available in STEP or IGES.

NOTE	
Purchased assembly includes box, lid and 4 cover screws. Flame retardant ABS carries UL flammability rating of 94 V-0. Various Battery holder kits available.	

PART NUMBERS	
1599H Fire Retardant ABS	
Black FR-ABS	1599HBKBAT
Grey FR-ABS	1599HGYBAT
1599H High Impact Polystyrene	
Black GP-ABS	1599HSBKBAT
Grey GP-ABS	1599HSGYBAT
ACCESSORIES	
Cover Screws for FR-ABS (Pkg 100)	1591MS100
[M3 - 0.5 x 20mm Nickel Plated Machine Screws]	
Cover Screws for GP-ABS (Pkg 100)	1598TS100
[#4 x 3/4" Stainless Steel Self Tapping Screws]	
P.C Board Mounting Screws (Pkg of 50 or 100)	1593ATS50
[#4 x 1/4" Self Tapping Screws]	1593ATS100

**HAMMOND
MANUFACTURING™**

1599HBAT

www.hammondmfg.com