

Data sheet | Item number: 2020-5372

3-conductor sensor supply terminal block; for PNP (positive) switching sensors; 1 mm²; Push-in CAGE CLAMP®; 1,00 mm²; orange

www.wago.com/2020-5372

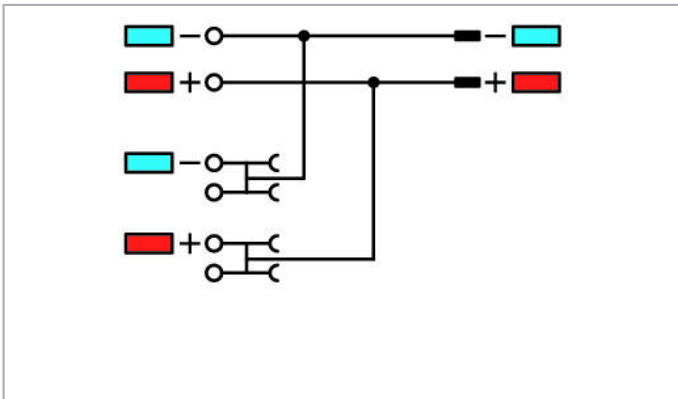
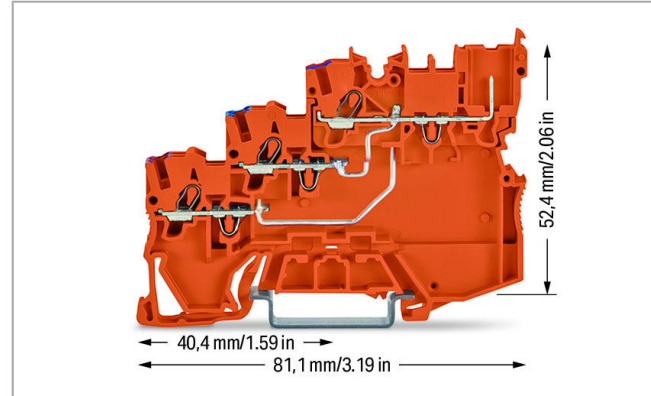
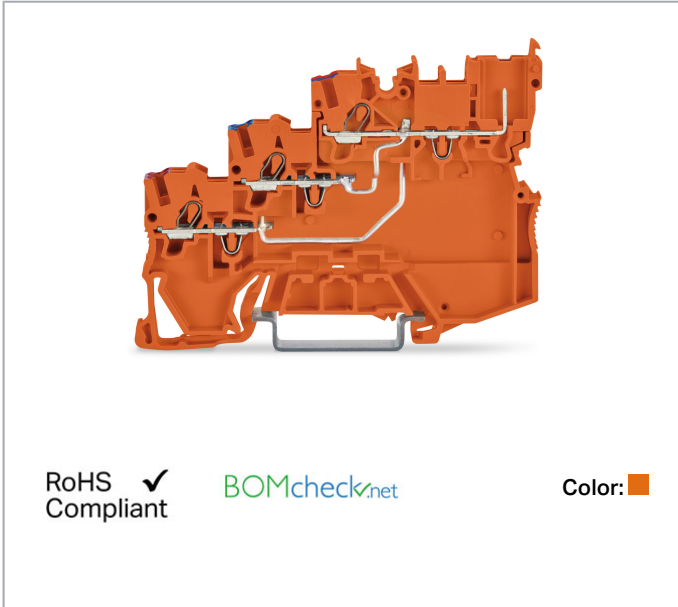

Item description

3.5 mm spacing per signal (2 x 3.5 mm = 7 mm)

The double spacing per pole of this terminal block series maximizes connectivity. For example, ten sensors may be connected using only five sensor terminal blocks plus a power supply terminal block.

Data

Electrical data

Subject to changes. Please also observe the further product documentation!

WAGO Kontakttechnik GmbH & Co. KG
Hansastr. 27
32423 Minden
Phone: +49571 887-0 | Fax: +49571 887-169
Email: info.de@wago.com | Web: www.wago.com

Do you have any questions about our products?
We are always happy to take your call at +49 (571) 887-44222.



Ratings per IEC/EN

Ratings per	IEC/EN 60947-7-1
Nominal voltage (III/3)	250 V
Rated surge voltage (III/3)	4 kV
Rated current	13.5 A
Legend (ratings)	(III / 3) $\hat{=}$ Overvoltage category III / Pollution degree 3

Ratings per UL

Approvals per	UL 1059
Rated voltage UL (Use Group B)	300 V
Rated current UL (Use Group B)	15 A
Rated voltage UL (Use Group D)	300 V
Rated current UL (Use Group D)	15 A

Ratings per CSA

Approvals per	C22.2 No 158
Rated voltage CSA (Use Group C)	300 V
Rated current CSA (Use Group C)	10 A

Connection data

Connection technology	Push-in CAGE CLAMP®
Actuation type	Push-in Open Tool Slot
Connectable conductor materials	Copper
Nominal cross-section	1 mm ²
Solid conductor	0.14 ... 1.5 mm ² / 24 ... 16 AWG
Solid conductor; push-in termination	0.5 ... 1.5 mm ² / 20 ... 16 AWG
Fine-stranded conductor	0.14 ... 1.5 mm ² / 24 ... 16 AWG
Fine-stranded conductor; with insulated ferrule	0.5 ... 0.75 mm ² / 20 ... 18 AWG
Fine-stranded conductor; with ferrule; push-in termination	0.5 ... 0.75 mm ² / 20 ... 18 AWG
Note (conductor cross-section)	Depending on the conductor characteristic, a conductor with a smaller cross-section can also be inserted via push-in termination.
Strip length	9 ... 11 mm / 0.35 ... 0.43 inch
Total number of connection points	6
Total number of potentials	4
Number of levels	3

Subject to changes. Please also observe the further product documentation!

WAGO Kontakttechnik GmbH & Co. KG
 Hansastr. 27
 32423 Minden
 Phone: +49571 887-0 | Fax: +49571 887-169
 Email: info.de@wago.com | Web: www.wago.com

Do you have any questions about our products?
 We are always happy to take your call at +49 (571) 887-44222.

Wiring type	Front-entry wiring
Number of jumper slots	4

Physical data

Width	7 mm / 0.276 inch
Height	81.1 mm / 3.193 inch

Mechanical data

Design	horizontal type
Mounting type	DIN-35 rail
Marking level	Center/side marking

Material data



Color	orange
Insulation material	Polyamide (PA66)
Weight	15.9 g

Commercial data

Packaging type	BOX
Country of origin	DE
GTIN	4055143523820
Customs tariff number	85369010000

Approvals / Certificates

Country specific Approvals

Logo	Approval	Additional Approval Text	Certificate name
	CCA DEKRA Certification B.V.	EN 60947	NTR NL 7617
	CSA DEKRA Certification B.V.	C22.2 No. 158	2516073
	KEMA/KEUR DEKRA Certification B.V.	EN 60947	71- 100670

Subject to changes. Please also observe the further product documentation!



UL-Approvals

Logo	Approval	Additional Approval Text	Certificate name
	UL UL International Germany GmbH	UL 1059	20171023-E45172

Required accessories

End plate







	Item no.: 2020-5391 End and intermediate plate; 1 mm thick; for 3-conductor terminal blocks; gray	www.wago.com/2020-5391
--	--	--

Compatible products

Coding

	Item no.: 2020-100 Carrier with 6 coding pins; for coding of female plugs; for carrier terminal blocks; orange	www.wago.com/2020-100
--	---	--

Carrier rail

	Item no.: 210-112 Steel carrier rail; 35 x 7.5 mm; 1 mm thick; 2 m long; slotted; according to EN 60715; "Hole width 25 mm; silver-colored	www.wago.com/210-112
	Item no.: 210-113 Steel carrier rail; 35 x 7.5 mm; 1 mm thick; 2 m long; unslotted; according to EN 60715; silver-colored	www.wago.com/210-113
	Item no.: 210-114 Steel carrier rail; 35 x 15 mm; 1.5 mm thick; 2 m long; unslotted; similar to EN 60715; silver-colored	www.wago.com/210-114
	Item no.: 210-115 Steel carrier rail; 35 x 7.5 mm; 1 mm thick; 2 m long; slotted; according to EN 60715; "Hole width 18 mm; silver-colored	www.wago.com/210-115
	Item no.: 210-118 Steel carrier rail; 35 x 15 mm; 2.3 mm thick; 2 m long; unslotted; according to EN 60715; silver-colored	www.wago.com/210-118
	Item no.: 210-196 Aluminum carrier rail; 35 x 8.2 mm; 1.6 mm thick; 2 m long; unslotted; similar to EN 60715; silver-colored	www.wago.com/210-196
	Item no.: 210-197 Steel carrier rail; 35 x 15 mm; 1.5 mm thick; 2 m long; slotted; similar to EN 60715; silver-colored	www.wago.com/210-197

Subject to changes. Please also observe the further product documentation!



Item no.: 210-198

Copper carrier rail; 35 x 15 mm; 2.3 mm thick; 2 m long; unslotted; according to EN 60715; copper-colored

www.wago.com/210-198

Female plug



Item no.: 2020-102

1-conductor female plug; 1.5 mm²; 2-pole; 1,50 mm²; gray

www.wago.com/2020-102

Item no.: 2020-102/122-000

1-conductor female plug; Locking lever; 1.5 mm²; 2-pole; 1,50 mm²; gray

www.wago.com/2020-102/122-000

Item no.: 2020-102/132-000

1-conductor female plug; Strain relief plate; 1.5 mm²; 2-pole; 1,50 mm²; gray

www.wago.com/2020-102/132-000

Item no.: 2020-102/142-000

1-conductor female plug; Strain relief plate; 1.5 mm²; 2-pole; 1,50 mm²; gray

www.wago.com/2020-102/142-000



Item no.: 2020-103

1-conductor female plug; 1.5 mm²; 3-pole; 1,50 mm²; gray

www.wago.com/2020-103



Item no.: 2020-103/000-036

1-conductor female plug; 1.5 mm²; 3-pole; 1,50 mm²; gray, green-yellow

www.wago.com/2020-103/000-036



Item no.: 2020-103/000-037

1-conductor female plug; 1.5 mm²; 3-pole; 1,50 mm²; green-yellow, gray

www.wago.com/2020-103/000-037



Item no.: 2020-103/000-038

1-conductor female plug; 1.5 mm²; 3-pole; 1,50 mm²; gray, blue, green-yellow

www.wago.com/2020-103/000-038



Item no.: 2020-103/000-039

1-conductor female plug; 1.5 mm²; 3-pole; 1,50 mm²; green-yellow, blue, gray

www.wago.com/2020-103/000-039

Item no.: 2020-103/122-000

1-conductor female plug; Locking lever; 1.5 mm²; 3-pole; 1,50 mm²; gray

www.wago.com/2020-103/122-000

Item no.: 2020-103/132-000

1-conductor female plug; Strain relief plate; 1.5 mm²; 3-pole; 1,50 mm²; gray

www.wago.com/2020-103/132-000

Item no.: 2020-103/142-000

1-conductor female plug; Strain relief plate; 1.5 mm²; 3-pole; 1,50 mm²; gray

www.wago.com/2020-103/142-000



Item no.: 2020-104

1-conductor female plug; 1.5 mm²; 4-pole; 1,50 mm²; gray

www.wago.com/2020-104

Subject to changes. Please also observe the further product documentation!

WAGO Kontakttechnik GmbH & Co. KG

Hansastr. 27











32423 Minden

Phone: +49571 887-0 | Fax: +49571 887-169











Email: info.de@wago.com | Web: www.wago.com

Do you have any questions about our products?









We are always happy to take your call at +49 (571) 887-44222.

	Item no.: 2020-104/000-036 1-conductor female plug; 1.5 mm ² ; 4-pole; 1,50 mm ² ; gray, green-yellow	www.wago.com/2020-104/000-036
	Item no.: 2020-104/000-037 1-conductor female plug; 1.5 mm ² ; 4-pole; 1,50 mm ² ; green-yellow, gray	www.wago.com/2020-104/000-037
	Item no.: 2020-104/000-038 1-conductor female plug; 1.5 mm ² ; 4-pole; 1,50 mm ² ; gray, blue, green-yellow	www.wago.com/2020-104/000-038
	Item no.: 2020-104/000-039 1-conductor female plug; 1.5 mm ² ; 4-pole; 1,50 mm ² ; green-yellow, blue, gray	www.wago.com/2020-104/000-039
	Item no.: 2020-104/124-000 1-conductor female plug; Locking lever; 1.5 mm ² ; 4-pole; 1,50 mm ² ; gray	www.wago.com/2020-104/124-000
	Item no.: 2020-104/133-000 1-conductor female plug; Strain relief plate; 1.5 mm ² ; 4-pole; 1,50 mm ² ; gray	www.wago.com/2020-104/133-000
	Item no.: 2020-104/143-000 1-conductor female plug; Strain relief plate; 1.5 mm ² ; 4-pole; 1,50 mm ² ; gray	www.wago.com/2020-104/143-000
	Item no.: 2020-105 1-conductor female plug; 1.5 mm ² ; 5-pole; 1,50 mm ² ; gray	www.wago.com/2020-105
	Item no.: 2020-105/000-036 1-conductor female plug; 1.5 mm ² ; 5-pole; 1,50 mm ² ; gray, green-yellow	www.wago.com/2020-105/000-036
	Item no.: 2020-105/000-037 1-conductor female plug; 1.5 mm ² ; 5-pole; 1,50 mm ² ; green-yellow, gray	www.wago.com/2020-105/000-037
	Item no.: 2020-105/000-038 1-conductor female plug; 1.5 mm ² ; 5-pole; 1,50 mm ² ; gray, blue, green-yellow	www.wago.com/2020-105/000-038
	Item no.: 2020-105/000-039 1-conductor female plug; 1.5 mm ² ; 5-pole; 1,50 mm ² ; green-yellow, blue, gray	www.wago.com/2020-105/000-039
	Item no.: 2020-105/124-000 1-conductor female plug; Locking lever; 1.5 mm ² ; 5-pole; 1,50 mm ² ; gray	www.wago.com/2020-105/124-000
	Item no.: 2020-105/133-000 1-conductor female plug; Strain relief plate; 1.5 mm ² ; 5-pole; 1,50 mm ² ; gray	www.wago.com/2020-105/133-000







Subject to changes. Please also observe the further product documentation!

	Item no.: 2020-105/143-000 1-conductor female plug; Strain relief plate; 1.5 mm ² ; 5-pole; 1,50 mm ² ; gray	www.wago.com/2020-105/143-000
	Item no.: 2020-106 1-conductor female plug; 1.5 mm ² ; 6-pole; 1,50 mm ² ; gray	www.wago.com/2020-106
	Item no.: 2020-106/000-036 1-conductor female plug; 1.5 mm ² ; 6-pole; 1,50 mm ² ; gray, green-yellow	www.wago.com/2020-106/000-036
	Item no.: 2020-106/000-037 1-conductor female plug; 1.5 mm ² ; 6-pole; 1,50 mm ² ; green-yellow, gray	www.wago.com/2020-106/000-037
	Item no.: 2020-106/000-038 1-conductor female plug; 1.5 mm ² ; 6-pole; 1,50 mm ² ; gray, blue, green-yellow	www.wago.com/2020-106/000-038
	Item no.: 2020-106/000-039 1-conductor female plug; 1.5 mm ² ; 6-pole; 1,50 mm ² ; green-yellow, blue, gray	www.wago.com/2020-106/000-039
	Item no.: 2020-106/124-000 1-conductor female plug; Locking lever; 1.5 mm ² ; 6-pole; 1,50 mm ² ; gray	www.wago.com/2020-106/124-000
	Item no.: 2020-106/133-000 1-conductor female plug; Strain relief plate; 1.5 mm ² ; 6-pole; 1,50 mm ² ; gray	www.wago.com/2020-106/133-000
	Item no.: 2020-106/143-000 1-conductor female plug; Strain relief plate; 1.5 mm ² ; 6-pole; 1,50 mm ² ; gray	www.wago.com/2020-106/143-000
	Item no.: 2020-107 1-conductor female plug; 1.5 mm ² ; 7-pole; 1,50 mm ² ; gray	www.wago.com/2020-107
	Item no.: 2020-107/000-036 1-conductor female plug; 1.5 mm ² ; 7-pole; 1,50 mm ² ; gray, green-yellow	www.wago.com/2020-107/000-036
	Item no.: 2020-107/000-037 1-conductor female plug; 1.5 mm ² ; 7-pole; 1,50 mm ² ; green-yellow, gray	www.wago.com/2020-107/000-037
	Item no.: 2020-107/000-038 1-conductor female plug; 1.5 mm ² ; 7-pole; 1,50 mm ² ; gray, blue, green-yellow	www.wago.com/2020-107/000-038
	Item no.: 2020-107/000-039 1-conductor female plug; 1.5 mm ² ; 7-pole; 1,50 mm ² ; green-yellow, blue, gray	www.wago.com/2020-107/000-039

Subject to changes. Please also observe the further product documentation!

	Item no.: 2020-107/124-000 1-conductor female plug; Locking lever; 1.5 mm ² ; 7-pole; 1,50 mm ² ; gray	www.wago.com/2020-107/124-000
	Item no.: 2020-107/134-000 1-conductor female plug; Strain relief plate; 1.5 mm ² ; 7-pole; 1,50 mm ² ; gray	www.wago.com/2020-107/134-000
	Item no.: 2020-107/144-000 1-conductor female plug; Strain relief plate; 1.5 mm ² ; 7-pole; 1,50 mm ² ; gray	www.wago.com/2020-107/144-000
	Item no.: 2020-108 1-conductor female plug; 1.5 mm ² ; 8-pole; 1,50 mm ² ; gray	www.wago.com/2020-108
	Item no.: 2020-108/000-036 1-conductor female plug; 1.5 mm ² ; 8-pole; 1,50 mm ² ; gray, green-yellow	www.wago.com/2020-108/000-036
	Item no.: 2020-108/000-037 1-conductor female plug; 1.5 mm ² ; 8-pole; 1,50 mm ² ; green-yellow, gray	www.wago.com/2020-108/000-037
	Item no.: 2020-108/000-038 1-conductor female plug; 1.5 mm ² ; 8-pole; 1,50 mm ² ; gray, blue, green-yellow	www.wago.com/2020-108/000-038
	Item no.: 2020-108/000-039 1-conductor female plug; 1.5 mm ² ; 8-pole; 1,50 mm ² ; green-yellow, blue, gray	www.wago.com/2020-108/000-039
	Item no.: 2020-108/124-000 1-conductor female plug; Locking lever; 1.5 mm ² ; 8-pole; 1,50 mm ² ; gray	www.wago.com/2020-108/124-000
	Item no.: 2020-108/134-000 1-conductor female plug; Strain relief plate; 1.5 mm ² ; 8-pole; 1,50 mm ² ; gray	www.wago.com/2020-108/134-000
	Item no.: 2020-108/144-000 1-conductor female plug; Strain relief plate; 1.5 mm ² ; 8-pole; 1,50 mm ² ; gray	www.wago.com/2020-108/144-000
	Item no.: 2020-109 1-conductor female plug; 1.5 mm ² ; 9-pole; 1,50 mm ² ; gray	www.wago.com/2020-109
	Item no.: 2020-109/000-036 1-conductor female plug; 1.5 mm ² ; 9-pole; 1,50 mm ² ; gray, green-yellow	www.wago.com/2020-109/000-036
	Item no.: 2020-109/000-037 1-conductor female plug; 1.5 mm ² ; 9-pole; 1,50 mm ² ; green-yellow, gray	www.wago.com/2020-109/000-037

Subject to changes. Please also observe the further product documentation!

	Item no.: 2020-109/000-038 1-conductor female plug; 1.5 mm ² ; 9-pole; 1,50 mm ² ; gray, blue, green-yellow	www.wago.com/2020-109/000-038
	Item no.: 2020-109/000-039 1-conductor female plug; 1.5 mm ² ; 9-pole; 1,50 mm ² ; green-yellow, blue, gray	www.wago.com/2020-109/000-039
	Item no.: 2020-109/124-000 1-conductor female plug; Locking lever; 1.5 mm ² ; 9-pole; 1,50 mm ² ; gray	www.wago.com/2020-109/124-000
	Item no.: 2020-109/134-000 1-conductor female plug; Strain relief plate; 1.5 mm ² ; 9-pole; 1,50 mm ² ; gray	www.wago.com/2020-109/134-000
	Item no.: 2020-109/144-000 1-conductor female plug; Strain relief plate; 1.5 mm ² ; 9-pole; 1,50 mm ² ; gray	www.wago.com/2020-109/144-000
	Item no.: 2020-110 1-conductor female plug; 1.5 mm ² ; 10-pole; 1,50 mm ² ; gray	www.wago.com/2020-110
	Item no.: 2020-110/000-036 1-conductor female plug; 1.5 mm ² ; 10-pole; 1,50 mm ² ; gray, green-yellow	www.wago.com/2020-110/000-036
	Item no.: 2020-110/000-037 1-conductor female plug; 1.5 mm ² ; 10-pole; 1,50 mm ² ; green-yellow, gray	www.wago.com/2020-110/000-037
	Item no.: 2020-110/000-038 1-conductor female plug; 1.5 mm ² ; 10-pole; 1,50 mm ² ; gray, blue, green-yellow	www.wago.com/2020-110/000-038
	Item no.: 2020-110/000-039 1-conductor female plug; 1.5 mm ² ; 10-pole; 1,50 mm ² ; green-yellow, blue, gray	www.wago.com/2020-110/000-039
	Item no.: 2020-110/125-000 1-conductor female plug; Locking lever; 1.5 mm ² ; 10-pole; 1,50 mm ² ; gray	www.wago.com/2020-110/125-000
	Item no.: 2020-110/135-000 1-conductor female plug; Strain relief plate; 1.5 mm ² ; 10-pole; 1,50 mm ² ; gray	www.wago.com/2020-110/135-000
	Item no.: 2020-110/145-000 1-conductor female plug; Strain relief plate; 1.5 mm ² ; 10-pole; 1,50 mm ² ; gray	www.wago.com/2020-110/145-000

Subject to changes. Please also observe the further product documentation!



Item no.: 2020-111
1-conductor female plug; 1.5 mm²; 11-pole; 1,50 mm²; gray

www.wago.com/2020-111



Item no.: 2020-111/000-036
1-conductor female plug; 1.5 mm²; 11-pole; 1,50 mm²; gray, green-yellow

www.wago.com/2020-111/000-036



Item no.: 2020-111/000-037
1-conductor female plug; 1.5 mm²; 11-pole; 1,50 mm²; green-yellow, gray

www.wago.com/2020-111/000-037



Item no.: 2020-111/000-038
1-conductor female plug; 1.5 mm²; 11-pole; 1,50 mm²; gray, blue, green-yellow

www.wago.com/2020-111/000-038



Item no.: 2020-111/000-039
1-conductor female plug; 1.5 mm²; 11-pole; 1,50 mm²; green-yellow, blue, gray

www.wago.com/2020-111/000-039

Item no.: 2020-111/125-000
1-conductor female plug; Locking lever; 1.5 mm²; 11-pole; 1,50 mm²; gray

www.wago.com/2020-111/125-000

Item no.: 2020-111/135-000
1-conductor female plug; Strain relief plate; 1.5 mm²; 11-pole; 1,50 mm²; gray

www.wago.com/2020-111/135-000

Item no.: 2020-111/145-000
1-conductor female plug; Strain relief plate; 1.5 mm²; 11-pole; 1,50 mm²; gray

www.wago.com/2020-111/145-000



Item no.: 2020-112
1-conductor female plug; 1.5 mm²; 12-pole; 1,50 mm²; gray

www.wago.com/2020-112



Item no.: 2020-112/000-036
1-conductor female plug; 1.5 mm²; 12-pole; 1,50 mm²; gray, green-yellow

www.wago.com/2020-112/000-036



Item no.: 2020-112/000-037
1-conductor female plug; 1.5 mm²; 12-pole; 1,50 mm²; green-yellow, gray

www.wago.com/2020-112/000-037



Item no.: 2020-112/000-038
1-conductor female plug; 1.5 mm²; 12-pole; 1,50 mm²; gray, blue, green-yellow

www.wago.com/2020-112/000-038











Item no.: 2020-112/000-039
1-conductor female plug; 1.5 mm²; 12-pole; 1,50 mm²; green-yellow, blue, gray

www.wago.com/2020-112/000-039

Item no.: 2020-112/125-000
1-conductor female plug; Locking lever; 1.5 mm²; 12-pole; 1,50 mm²; gray

www.wago.com/2020-112/125-000

Subject to changes. Please also observe the further product documentation!

	Item no.: 2020-112/135-000 1-conductor female plug; Strain relief plate; 1.5 mm ² ; 12-pole; 1,50 mm ² ; gray	www.wago.com/2020-112/135-000
	Item no.: 2020-112/145-000 1-conductor female plug; Strain relief plate; 1.5 mm ² ; 12-pole; 1,50 mm ² ; gray	www.wago.com/2020-112/145-000
	Item no.: 2020-113 1-conductor female plug; 1.5 mm ² ; 13-pole; 1,50 mm ² ; gray	www.wago.com/2020-113
	Item no.: 2020-113/000-036 1-conductor female plug; 1.5 mm ² ; 13-pole; 1,50 mm ² ; gray, green-yellow	www.wago.com/2020-113/000-036
	Item no.: 2020-113/000-037 1-conductor female plug; 1.5 mm ² ; 13-pole; 1,50 mm ² ; green-yellow, gray	www.wago.com/2020-113/000-037
	Item no.: 2020-113/000-038 1-conductor female plug; 1.5 mm ² ; 13-pole; 1,50 mm ² ; gray, blue, green-yellow	www.wago.com/2020-113/000-038
	Item no.: 2020-113/000-039 1-conductor female plug; 1.5 mm ² ; 13-pole; 1,50 mm ² ; green-yellow, blue, gray	www.wago.com/2020-113/000-039
	Item no.: 2020-113/125-000 1-conductor female plug; Locking lever; 1.5 mm ² ; 13-pole; 1,50 mm ² ; gray	www.wago.com/2020-113/125-000
	Item no.: 2020-113/135-000 1-conductor female plug; Strain relief plate; 1.5 mm ² ; 13-pole; 1,50 mm ² ; gray	www.wago.com/2020-113/135-000
	Item no.: 2020-113/145-000 1-conductor female plug; Strain relief plate; 1.5 mm ² ; 13-pole; 1,50 mm ² ; gray	www.wago.com/2020-113/145-000
	Item no.: 2020-114 1-conductor female plug; 1.5 mm ² ; 14-pole; 1,50 mm ² ; gray	www.wago.com/2020-114
	Item no.: 2020-114/000-036 1-conductor female plug; 1.5 mm ² ; 14-pole; 1,50 mm ² ; gray, green-yellow	www.wago.com/2020-114/000-036
	Item no.: 2020-114/000-037 1-conductor female plug; 1.5 mm ² ; 14-pole; 1,50 mm ² ; green-yellow, gray	www.wago.com/2020-114/000-037
	Item no.: 2020-114/000-038 1-conductor female plug; 1.5 mm ² ; 14-pole; 1,50 mm ² ; gray, blue, green-yellow	www.wago.com/2020-114/000-038

Subject to changes. Please also observe the further product documentation!



Item no.: 2020-114/000-039

1-conductor female plug; 1.5 mm²; 14-pole; 1,50 mm²; green-yellow, blue, gray

www.wago.com/2020-114/000-039

Item no.: 2020-114/125-000

1-conductor female plug; Locking lever; 1.5 mm²; 14-pole; 1,50 mm²; gray

www.wago.com/2020-114/125-000

Item no.: 2020-114/135-000

1-conductor female plug; Strain relief plate; 1.5 mm²; 14-pole; 1,50 mm²; gray

www.wago.com/2020-114/135-000

Item no.: 2020-114/145-000

1-conductor female plug; Strain relief plate; 1.5 mm²; 14-pole; 1,50 mm²; gray

www.wago.com/2020-114/145-000



Item no.: 2020-115

1-conductor female plug; 1.5 mm²; 15-pole; 1,50 mm²; gray

www.wago.com/2020-115



Item no.: 2020-115/000-036

1-conductor female plug; 1.5 mm²; 15-pole; 1,50 mm²; gray, green-yellow

www.wago.com/2020-115/000-036



Item no.: 2020-115/000-037

1-conductor female plug; 1.5 mm²; 15-pole; 1,50 mm²; green-yellow, gray

www.wago.com/2020-115/000-037



Item no.: 2020-115/000-038

1-conductor female plug; 1.5 mm²; 15-pole; 1,50 mm²; gray, blue, green-yellow

www.wago.com/2020-115/000-038



Item no.: 2020-115/000-039

1-conductor female plug; 1.5 mm²; 15-pole; 1,50 mm²; green-yellow, blue, gray

www.wago.com/2020-115/000-039

Item no.: 2020-115/125-000

1-conductor female plug; Locking lever; 1.5 mm²; 15-pole; 1,50 mm²; gray

www.wago.com/2020-115/125-000

Item no.: 2020-115/135-000

1-conductor female plug; Strain relief plate; 1.5 mm²; 15-pole; 1,50 mm²; gray

www.wago.com/2020-115/135-000

Item no.: 2020-115/145-000

1-conductor female plug; Strain relief plate; 1.5 mm²; 15-pole; 1,50 mm²; gray

www.wago.com/2020-115/145-000



Item no.: 2020-161

Start module for 1-conductor female connector; with integrated end plate; 1.5 mm²; 1-pole; 1,50 mm²; gray

www.wago.com/2020-161



Item no.: 2020-164

Start module for 1-conductor female connector; with integrated end plate; 1.5 mm²; 1-pole; 1,50 mm²; blue

www.wago.com/2020-164

Subject to changes. Please also observe the further product documentation!

WAGO Kontakttechnik GmbH & Co. KG

Hansastr. 27















32423 Minden

Phone: +49571 887-0 | Fax: +49571 887-169















Email: info.de@wago.com | Web: www.wago.com

Do you have any questions about our products?

We are always happy to take your call at +49 (571) 887-44222.

	Item no.: 2020-167 Start module for 1-conductor female connector; 1.5 mm ² ; 1-pole; 1,50 mm ² ; green-yellow	www.wago.com/2020-167
	Item no.: 2020-181 End module for 1-conductor female connector; 1.5 mm ² ; 1-pole; 1,50 mm ² ; gray	www.wago.com/2020-181
	Item no.: 2020-184 End module for 1-conductor female connector; 1.5 mm ² ; 1-pole; 1,50 mm ² ; blue	www.wago.com/2020-184
	Item no.: 2020-187 End module for 1-conductor female connector; 1.5 mm ² ; 1-pole; 1,50 mm ² ; green-yellow	www.wago.com/2020-187
	Item no.: 2020-202 2-conductor female connector; 1.5 mm ² ; 2-pole; 1,50 mm ² ; gray	www.wago.com/2020-202
	Item no.: 2020-203 2-conductor female connector; 1.5 mm ² ; 3-pole; 1,50 mm ² ; gray	www.wago.com/2020-203
	Item no.: 2020-203/000-036 2-conductor female connector; 1.5 mm ² ; 3-pole; 1,50 mm ² ; gray, green-yellow	www.wago.com/2020-203/000-036
	Item no.: 2020-203/000-037 2-conductor female connector; 1.5 mm ² ; 3-pole; 1,50 mm ² ; green-yellow, gray	www.wago.com/2020-203/000-037
	Item no.: 2020-203/000-038 2-conductor female connector; 1.5 mm ² ; 3-pole; 1,50 mm ² ; gray, blue, green-yellow	www.wago.com/2020-203/000-038
	Item no.: 2020-203/000-039 2-conductor female connector; 1.5 mm ² ; 3-pole; 1,50 mm ² ; green-yellow, blue, gray	www.wago.com/2020-203/000-039
	Item no.: 2020-204 2-conductor female connector; 1.5 mm ² ; 4-pole; 1,50 mm ² ; gray	www.wago.com/2020-204
	Item no.: 2020-204/000-036 2-conductor female connector; 1.5 mm ² ; 4-pole; 1,50 mm ² ; gray, green-yellow	www.wago.com/2020-204/000-036
	Item no.: 2020-204/000-037 2-conductor female connector; 1.5 mm ² ; 4-pole; 1,50 mm ² ; green-yellow, gray	www.wago.com/2020-204/000-037
	Item no.: 2020-204/000-038 2-conductor female connector; 1.5 mm ² ; 4-pole; 1,50 mm ² ; gray, blue, green-yellow	www.wago.com/2020-204/000-038
	Item no.: 2020-204/000-039 2-conductor female connector; 1.5 mm ² ; 4-pole; 1,50 mm ² ; green-yellow, blue, gray	www.wago.com/2020-204/000-039

Subject to changes. Please also observe the further product documentation!

	Item no.: 2020-205 2-conductor female connector; 1.5 mm ² ; 5-pole; 1,50 mm ² ; gray	www.wago.com/2020-205
	Item no.: 2020-205/000-036 2-conductor female connector; 1.5 mm ² ; 5-pole; 1,50 mm ² ; gray, green-yellow	www.wago.com/2020-205/000-036
	Item no.: 2020-205/000-037 2-conductor female connector; 1.5 mm ² ; 5-pole; 1,50 mm ² ; green-yellow, gray	www.wago.com/2020-205/000-037
	Item no.: 2020-205/000-038 2-conductor female connector; 1.5 mm ² ; 5-pole; 1,50 mm ² ; gray, blue, green-yellow	www.wago.com/2020-205/000-038
	Item no.: 2020-205/000-039 2-conductor female connector; 1.5 mm ² ; 5-pole; 1,50 mm ² ; green-yellow, blue, gray	www.wago.com/2020-205/000-039
	Item no.: 2020-206 2-conductor female connector; 1.5 mm ² ; 6-pole; 1,50 mm ² ; gray	www.wago.com/2020-206
	Item no.: 2020-206/000-036 2-conductor female connector; 1.5 mm ² ; 6-pole; 1,50 mm ² ; gray, green-yellow	www.wago.com/2020-206/000-036
	Item no.: 2020-206/000-037 2-conductor female connector; 1.5 mm ² ; 6-pole; 1,50 mm ² ; green-yellow, gray	www.wago.com/2020-206/000-037
	Item no.: 2020-206/000-038 2-conductor female connector; 1.5 mm ² ; 6-pole; 1,50 mm ² ; gray, blue, green-yellow	www.wago.com/2020-206/000-038
	Item no.: 2020-206/000-039 2-conductor female connector; 1.5 mm ² ; 6-pole; 1,50 mm ² ; green-yellow, blue, gray	www.wago.com/2020-206/000-039
	Item no.: 2020-207 2-conductor female connector; 1.5 mm ² ; 7-pole; 1,50 mm ² ; gray	www.wago.com/2020-207
	Item no.: 2020-207/000-036 2-conductor female connector; 1.5 mm ² ; 7-pole; 1,50 mm ² ; gray, green-yellow	www.wago.com/2020-207/000-036
	Item no.: 2020-207/000-037 2-conductor female connector; 1.5 mm ² ; 7-pole; 1,50 mm ² ; green-yellow, gray	www.wago.com/2020-207/000-037
	Item no.: 2020-207/000-038 2-conductor female connector; 1.5 mm ² ; 7-pole; 1,50 mm ² ; gray, blue, green-yellow	www.wago.com/2020-207/000-038

Subject to changes. Please also observe the further product documentation!



Item no.: 2020-207/000-039
2-conductor female connector; 1.5 mm²; 7-pole; 1,50 mm²; green-yellow, blue, gray

www.wago.com/2020-207/000-039



Item no.: 2020-208
2-conductor female connector; 1.5 mm²; 8-pole; 1,50 mm²; gray

www.wago.com/2020-208



Item no.: 2020-208/000-036
2-conductor female connector; 1.5 mm²; 8-pole; 1,50 mm²; gray, green-yellow

www.wago.com/2020-208/000-036



Item no.: 2020-208/000-037
2-conductor female connector; 1.5 mm²; 8-pole; 1,50 mm²; green-yellow, gray

www.wago.com/2020-208/000-037



Item no.: 2020-208/000-038
2-conductor female connector; 1.5 mm²; 8-pole; 1,50 mm²; gray, blue, green-yellow

www.wago.com/2020-208/000-038



Item no.: 2020-208/000-039
2-conductor female connector; 1.5 mm²; 8-pole; 1,50 mm²; green-yellow, blue, gray

www.wago.com/2020-208/000-039



Item no.: 2020-209
2-conductor female connector; 1.5 mm²; 9-pole; 1,50 mm²; gray

www.wago.com/2020-209



Item no.: 2020-209/000-036
2-conductor female connector; 1.5 mm²; 9-pole; 1,50 mm²; gray, green-yellow

www.wago.com/2020-209/000-036



Item no.: 2020-209/000-037
2-conductor female connector; 1.5 mm²; 9-pole; 1,50 mm²; green-yellow, gray

www.wago.com/2020-209/000-037



Item no.: 2020-209/000-038
2-conductor female connector; 1.5 mm²; 9-pole; 1,50 mm²; gray, blue, green-yellow

www.wago.com/2020-209/000-038



Item no.: 2020-209/000-039
2-conductor female connector; 1.5 mm²; 9-pole; 1,50 mm²; green-yellow, blue, gray

www.wago.com/2020-209/000-039



Item no.: 2020-210
2-conductor female connector; 1.5 mm²; 10-pole; 1,50 mm²; gray

www.wago.com/2020-210



Item no.: 2020-210/000-036
2-conductor female connector; 1.5 mm²; 10-pole; 1,50 mm²; gray, green-yellow















www.wago.com/2020-210/000-036



Item no.: 2020-210/000-037
2-conductor female connector; 1.5 mm²; 10-pole; 1,50 mm²; green-yellow, gray

www.wago.com/2020-210/000-037

Subject to changes. Please also observe the further product documentation!

	<p>Item no.: 2020-210/000-038 2-conductor female connector; 1.5 mm²; 10-pole; 1,50 mm²; gray, blue, green-yellow</p>	www.wago.com/2020-210/000-038
	<p>Item no.: 2020-210/000-039 2-conductor female connector; 1.5 mm²; 10-pole; 1,50 mm²; green-yellow, blue, gray</p>	www.wago.com/2020-210/000-039
	<p>Item no.: 2020-211 2-conductor female connector; 1.5 mm²; 11-pole; 1,50 mm²; gray</p>	www.wago.com/2020-211
	<p>Item no.: 2020-211/000-036 2-conductor female connector; 1.5 mm²; 11-pole; 1,50 mm²; gray, green-yellow</p>	www.wago.com/2020-211/000-036
	<p>Item no.: 2020-211/000-037 2-conductor female connector; 1.5 mm²; 11-pole; 1,50 mm²; green-yellow, gray</p>	www.wago.com/2020-211/000-037
	<p>Item no.: 2020-211/000-038 2-conductor female connector; 1.5 mm²; 11-pole; 1,50 mm²; gray, blue, green-yellow</p>	www.wago.com/2020-211/000-038
	<p>Item no.: 2020-211/000-039 2-conductor female connector; 1.5 mm²; 11-pole; 1,50 mm²; green-yellow, blue, gray</p>	www.wago.com/2020-211/000-039
	<p>Item no.: 2020-212 2-conductor female connector; 1.5 mm²; 12-pole; 1,50 mm²; gray</p>	www.wago.com/2020-212
	<p>Item no.: 2020-212/000-036 2-conductor female connector; 1.5 mm²; 12-pole; 1,50 mm²; gray, green-yellow</p>	www.wago.com/2020-212/000-036
	<p>Item no.: 2020-212/000-037 2-conductor female connector; 1.5 mm²; 12-pole; 1,50 mm²; green-yellow, gray</p>	www.wago.com/2020-212/000-037
	<p>Item no.: 2020-212/000-038 2-conductor female connector; 1.5 mm²; 12-pole; 1,50 mm²; gray, blue, green-yellow</p>	www.wago.com/2020-212/000-038
	<p>Item no.: 2020-212/000-039 2-conductor female connector; 1.5 mm²; 12-pole; 1,50 mm²; green-yellow, blue, gray</p>	www.wago.com/2020-212/000-039
	<p>Item no.: 2020-213 2-conductor female connector; 1.5 mm²; 13-pole; 1,50 mm²; gray</p>	www.wago.com/2020-213
	<p>Item no.: 2020-213/000-036 2-conductor female connector; 1.5 mm²; 13-pole; 1,50 mm²; gray, green-yellow</p>	www.wago.com/2020-213/000-036

Subject to changes. Please also observe the further product documentation!



Item no.: 2020-213/000-037
2-conductor female connector; 1.5 mm²; 13-pole; 1,50 mm²; green-yellow, gray

www.wago.com/2020-213/000-037



Item no.: 2020-213/000-038
2-conductor female connector; 1.5 mm²; 13-pole; 1,50 mm²; gray, blue, green-yellow

www.wago.com/2020-213/000-038



Item no.: 2020-213/000-039
2-conductor female connector; 1.5 mm²; 13-pole; 1,50 mm²; green-yellow, blue, gray

www.wago.com/2020-213/000-039



Item no.: 2020-214
2-conductor female connector; 1.5 mm²; 14-pole; 1,50 mm²; gray

www.wago.com/2020-214



Item no.: 2020-214/000-036
2-conductor female connector; 1.5 mm²; 14-pole; 1,50 mm²; gray, green-yellow

www.wago.com/2020-214/000-036



Item no.: 2020-214/000-037
2-conductor female connector; 1.5 mm²; 14-pole; 1,50 mm²; green-yellow, gray

www.wago.com/2020-214/000-037



Item no.: 2020-214/000-038
2-conductor female connector; 1.5 mm²; 14-pole; 1,50 mm²; gray, blue, green-yellow

www.wago.com/2020-214/000-038



Item no.: 2020-214/000-039
2-conductor female connector; 1.5 mm²; 14-pole; 1,50 mm²; green-yellow, blue, gray

www.wago.com/2020-214/000-039



Item no.: 2020-215
2-conductor female connector; 1.5 mm²; 15-pole; 1,50 mm²; gray

www.wago.com/2020-215



Item no.: 2020-215/000-036
2-conductor female connector; 1.5 mm²; 15-pole; 1,50 mm²; gray, green-yellow

www.wago.com/2020-215/000-036



Item no.: 2020-215/000-037
2-conductor female connector; 1.5 mm²; 15-pole; 1,50 mm²; green-yellow, gray

www.wago.com/2020-215/000-037



Item no.: 2020-215/000-038
2-conductor female connector; 1.5 mm²; 15-pole; 1,50 mm²; gray, blue, green-yellow

www.wago.com/2020-215/000-038



Item no.: 2020-215/000-039
2-conductor female connector; 1.5 mm²; 15-pole; 1,50 mm²; green-yellow, blue, gray

www.wago.com/2020-215/000-039

















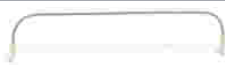

Item no.: 2020-261
Start module for 2-conductor female connector; with integrated end plate; 1.5 mm²; 1-pole; 1,50 mm²; gray















www.wago.com/2020-261

Item no.: 2020-264















Subject to changes. Please also observe the further product documentation!

	Start module for 2-conductor female connector; with integrated end plate; 1.5 mm ² ; 1-pole; 1,50 mm ² ; blue	www.wago.com/2020-264
	Item no.: 2020-267 Start module for 2-conductor female connector; 1.5 mm ² ; 1-pole; 1,50 mm ² ; green-yellow	www.wago.com/2020-267
	Item no.: 2020-281 End module for 2-conductor female connector; 1.5 mm ² ; 1-pole; 1,50 mm ² ; gray	www.wago.com/2020-281
	Item no.: 2020-284 End module for 2-conductor female connector; 1.5 mm ² ; 1-pole; 1,50 mm ² ; blue	www.wago.com/2020-284
	Item no.: 2020-287 End module for 2-conductor female connector; 1.5 mm ² ; 1-pole; 1,50 mm ² ; green-yellow	www.wago.com/2020-287
Push-In type wire jumper		
	Item no.: 2009-402 Push-in type wire jumper; 0.75 mm ² ; insulated; 60 mm long; gray	www.wago.com/2009-402
	Item no.: 2009-404 Push-in type wire jumper; 0.75 mm ² ; insulated; 110 mm long; gray	www.wago.com/2009-404
	Item no.: 2009-406 Push-in type wire jumper; 0.75 mm ² ; insulated; 250 mm long; gray	www.wago.com/2009-406
check		
	Item no.: 2000-510 TOPJOB®S L-type test plug module; modular; for jumper contact slot; 1,00 mm ² ; gray	www.wago.com/2000-510
	Item no.: 2000-552 Modular TOPJOB®S connector; modular; for jumper contact slot; 2-pole; 1,00 mm ² ; gray	www.wago.com/2000-552
	Item no.: 2000-553 Modular TOPJOB®S connector; modular; for jumper contact slot; 3-pole; 1,00 mm ² ; gray	www.wago.com/2000-553
	Item no.: 2000-554 Modular TOPJOB®S connector; modular; for jumper contact slot; 4-pole; 1,00 mm ² ; gray	www.wago.com/2000-554
	Item no.: 2000-555 Modular TOPJOB®S connector; modular; for jumper contact slot; 5-pole; 1,00 mm ² ; gray	www.wago.com/2000-555
	Item no.: 2000-556 Modular TOPJOB®S connector; modular; for jumper contact slot; 6-pole; 1,00 mm ² ; gray	www.wago.com/2000-556
	Item no.: 2000-557 Modular TOPJOB®S connector; modular; for jumper contact slot; 7-pole; 1,00 mm ² ; gray	www.wago.com/2000-557
	Item no.: 2000-558 Modular TOPJOB®S connector; modular; for jumper contact slot; 8-pole; 1,00 mm ² ; gray	www.wago.com/2000-558
	Item no.: 2000-559 Modular TOPJOB®S connector; modular; for jumper contact slot; 9-pole; 1,00 mm ² ; gray	www.wago.com/2000-559
	Item no.: 2000-560	















Subject to changes. Please also observe the further product documentation!

	Modular TOPJOB®S connector; modular; for jumper contact slot; 10-pole; 1,00 mm ² ; gray	www.wago.com/2000-560
	Item no.: 2009-174 Test plug adapter; for 4 mm Ø test plugs; for testing TOPJOB®S rail-mounted terminal blocks; gray	www.wago.com/2009-174
	Item no.: 2009-182 Testing tap; for max. 2.5 mm ² ; tool-free connection for individual test wires 0.08 - 2.5 mm; gray	www.wago.com/2009-182
Protective Warning Marker		
	Item no.: 2000-115 Protective warning marker; with high-voltage symbol, black; for 5 terminal blocks; yellow	www.wago.com/2000-115
Marking accessories		
	Item no.: 2000-121 Adaptor; gray	www.wago.com/2000-121
	Item no.: 2009-110 Marking strips; for Smart Printer; on reel; not stretchable; plain; snap-on type; white	www.wago.com/2009-110
	Item no.: 2009-113 WMB-Inline; for Smart Printer; 2300 pieces on roll; plain; snap-on type; white	www.wago.com/2009-113
	Item no.: 2009-113/000-002 WMB-Inline; for Smart Printer; 2300 pieces on roll; plain; snap-on type; yellow	www.wago.com/2009-113/000-002
	Item no.: 2009-113/000-005 WMB-Inline; for Smart Printer; 2300 pieces on roll; plain; snap-on type; red	www.wago.com/2009-113/000-005
	Item no.: 2009-113/000-006 WMB-Inline; for Smart Printer; 2300 pieces on roll; plain; snap-on type; blue	www.wago.com/2009-113/000-006
	Item no.: 2009-113/000-007 WMB-Inline; for Smart Printer; 2300 pieces on roll; plain; snap-on type; gray	www.wago.com/2009-113/000-007
	Item no.: 2009-113/000-012 WMB-Inline; for Smart Printer; 2300 pieces on roll; plain; snap-on type; orange	www.wago.com/2009-113/000-012
	Item no.: 2009-113/000-017 WMB-Inline; for Smart Printer; 2300 pieces on roll; plain; snap-on type; light green	www.wago.com/2009-113/000-017
	Item no.: 2009-113/000-023 WMB-Inline; for Smart Printer; 2300 pieces on roll; plain; snap-on type; green	www.wago.com/2009-113/000-023
	Item no.: 2009-113/000-024 WMB-Inline; for Smart Printer; 2300 pieces on roll; plain; snap-on type; violet	www.wago.com/2009-113/000-024

















Subject to changes. Please also observe the further product documentation!

	Item no.: 2009-191 Group marker carrier	www.wago.com/2009-191
	Item no.: 793-3501 WMB marking card; as card; plain; snap-on type; white	www.wago.com/793-3501
tools		
	Item no.: 210-647 Operating tool; Blade: 2.5 x 0.4 mm; with a partially insulated shaft; multicoloured	www.wago.com/210-647
	Item no.: 210-648 Operating tool; Blade: 2.5 x 0.4 mm; with a partially insulated shaft; angled; short	www.wago.com/210-648
	Item no.: 210-719 Operating tool; Blade: 2.5 x 0.4 mm; with a partially insulated shaft	www.wago.com/210-719
Jumper		
	Item no.: 2000-402 Jumper; 2-way; insulated; light gray	www.wago.com/2000-402
	Item no.: 2000-402/000-005 Jumper; 2-way; insulated; red	www.wago.com/2000-402/000-005
	Item no.: 2000-402/000-006 Jumper; 2-way; insulated; blue	www.wago.com/2000-402/000-006
	Item no.: 2000-402/000-018 Jumper; 2-way; insulated; yellow-green	www.wago.com/2000-402/000-018
	Item no.: 2000-403 Jumper; 3-way; insulated; light gray	www.wago.com/2000-403
	Item no.: 2000-403/000-005 Jumper; 3-way; insulated; red	www.wago.com/2000-403/000-005
	Item no.: 2000-403/000-006 Jumper; 3-way; insulated; blue	www.wago.com/2000-403/000-006
	Item no.: 2000-404 Jumper; 4-way; insulated; light gray	www.wago.com/2000-404
	Item no.: 2000-404/000-005 Jumper; 4-way; insulated; red	www.wago.com/2000-404/000-005
	Item no.: 2000-404/000-006 Jumper; 4-way; insulated; blue	www.wago.com/2000-404/000-006

Subject to changes. Please also observe the further product documentation!

	Item no.: 2000-405 Jumper; 5-way; insulated; light gray	www.wago.com/2000-405
	Item no.: 2000-405/000-005 Jumper; 5-way; insulated; red	www.wago.com/2000-405/000-005
	Item no.: 2000-405/000-006 Jumper; 5-way; insulated; blue	www.wago.com/2000-405/000-006
	Item no.: 2000-405/011-000 Star point jumper; 3-way; insulated; light gray	www.wago.com/2000-405/011-000
	Item no.: 2000-406 Jumper; 6-way; insulated; light gray	www.wago.com/2000-406
	Item no.: 2000-406/000-005 Jumper; 6-way; insulated; red	www.wago.com/2000-406/000-005
	Item no.: 2000-406/000-006 Jumper; 6-way; insulated; blue	www.wago.com/2000-406/000-006
	Item no.: 2000-406/020-000 Delta jumper; insulated; light gray	www.wago.com/2000-406/020-000
	Item no.: 2000-407 Jumper; 7-way; insulated; light gray	www.wago.com/2000-407
	Item no.: 2000-407/000-005 Jumper; 7-way; insulated; red	www.wago.com/2000-407/000-005
	Item no.: 2000-407/000-006 Jumper; 7-way; insulated; blue	www.wago.com/2000-407/000-006
	Item no.: 2000-408 Jumper; 8-way; insulated; light gray	www.wago.com/2000-408
	Item no.: 2000-408/000-005 Jumper; 8-way; insulated; red	www.wago.com/2000-408/000-005
	Item no.: 2000-408/000-006 Jumper; 8-way; insulated; blue	www.wago.com/2000-408/000-006

Subject to changes. Please also observe the further product documentation!

	Item no.: 2000-409 Jumper; 9-way; insulated; light gray	www.wago.com/2000-409
	Item no.: 2000-409/000-005 Jumper; 9-way; insulated; red	www.wago.com/2000-409/000-005
	Item no.: 2000-409/000-006 Jumper; 9-way; insulated; blue	www.wago.com/2000-409/000-006
	Item no.: 2000-410 Jumper; 10-way; insulated; light gray	www.wago.com/2000-410
	Item no.: 2000-410/000-005 Jumper; 10-way; insulated; red	www.wago.com/2000-410/000-005
	Item no.: 2000-410/000-006 Jumper; 10-way; insulated; blue	www.wago.com/2000-410/000-006
	Item no.: 2000-433 Jumper; from 1 to 3; insulated; light gray	www.wago.com/2000-433
	Item no.: 2000-433/000-005 Jumper; from 1 to 3; insulated; red	www.wago.com/2000-433/000-005
	Item no.: 2000-433/000-006 Jumper; from 1 to 3; insulated; blue	www.wago.com/2000-433/000-006
	Item no.: 2000-434 Jumper; from 1 to 4; insulated; light gray	www.wago.com/2000-434
	Item no.: 2000-435 Jumper; from 1 to 5; insulated; light gray	www.wago.com/2000-435
	Item no.: 2000-436 Jumper; from 1 to 6; insulated; light gray	www.wago.com/2000-436
	Item no.: 2000-437 Jumper; from 1 to 7; insulated; light gray	www.wago.com/2000-437
	Item no.: 2000-438 Jumper; from 1 to 8; insulated; light gray	www.wago.com/2000-438
	Item no.: 2000-439 Jumper; from 1 to 9; insulated; light gray	www.wago.com/2000-439
	Item no.: 2000-440 Jumper; from 1 to 10; insulated; light gray	www.wago.com/2000-440

Subject to changes. Please also observe the further product documentation!



Item no.: 210-103
Wire commoning chain; insulated; black

www.wago.com/210-103

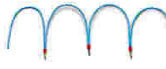

Item no.: 210-123
Wire commoning chain; insulated; blue

www.wago.com/210-123

ferrule



Item no.: 216-241
Ferrule; Sleeve for 0.5 mm² / 20 AWG; insulated; electro-tin plated; electrolytic copper; gastight crimped; acc. to DIN 46228, Part 4/09.90; white

www.wago.com/216-241



Item no.: 216-242
Ferrule; Sleeve for 0.75 mm² / 18 AWG; insulated; electro-tin plated; electrolytic copper; gastight crimped; acc. to DIN 46228, Part 4/09.90; gray

www.wago.com/216-242



Item no.: 216-243
Ferrule; Sleeve for 1 mm² / AWG 18; insulated; electro-tin plated; electrolytic copper; gastight crimped; acc. to DIN 46228, Part 4/09.90; red

www.wago.com/216-243

Downloads

Documentation

Bid Text

2020-5372 X81 - Datei	21. 2. 2019	xml 4.6 kB	Download
--------------------------	-------------	---------------	----------

2020-5372 docx - Datei	21. 2. 2019	docx 15.7 kB	Download
---------------------------	-------------	-----------------	----------

Additional Information

Technical explanations	3. 4. 2019	pdf 2.2 MB	Download
------------------------	------------	---------------	----------

CAD/CAE-Data

CAD data

2D/3D Models 2020-5372		URL	Download
------------------------	--	-----	----------

CAE data

ZUKEN Portal 2020-5372		URL	Download
------------------------	--	-----	----------

Environmental Product Compliance

Compliance Search

Subject to changes. Please also observe the further product documentation!

Environmental Product Compliance 2020-5372

3-conductor sensor supply terminal block; for PNP (positive) switching sensors; 1 mm²; Push-in CAGE CLAMP®; 1,00 mm²; orange

Installation Notes

Installation

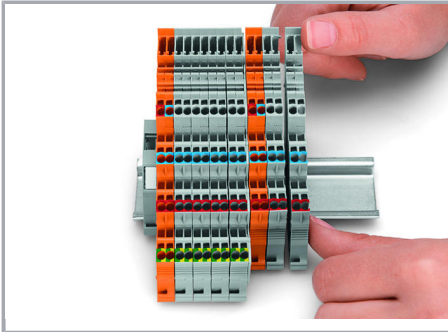

Snap individual terminal blocks onto the DIN-rail and slide together.

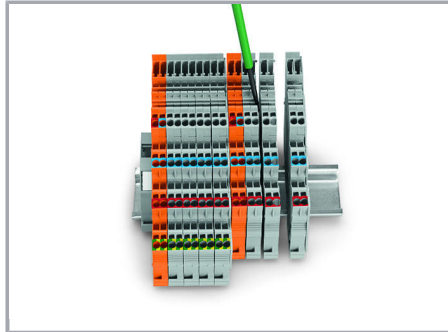

Separate terminal block assembly and slide individual terminal blocks laterally using an operating tool.

Testing

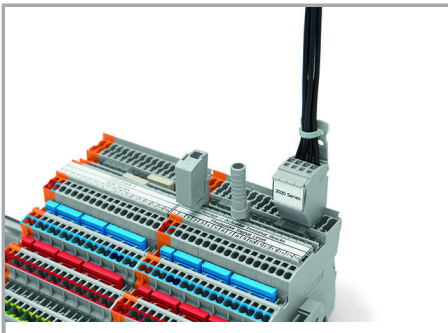

Testing via testing tap (2009-182) or test plug adapter (2009-174) (up to max. 42 V).

Coding

Subject to changes. Please also observe the further product documentation!

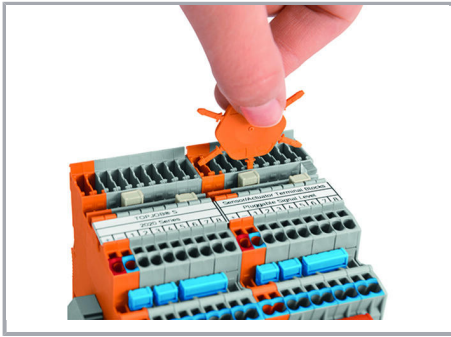

Insert coding pin into the corresponding slot and twist it off.

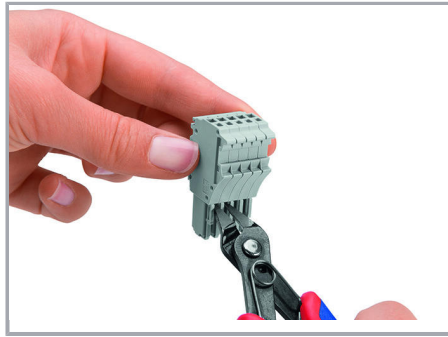

Remove the coding finger using a cutting tool.

Locking system

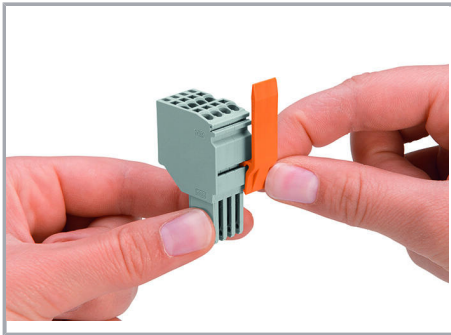

Slide the locking lever into position.

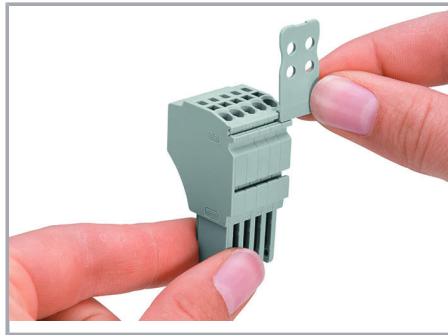

Strain relief

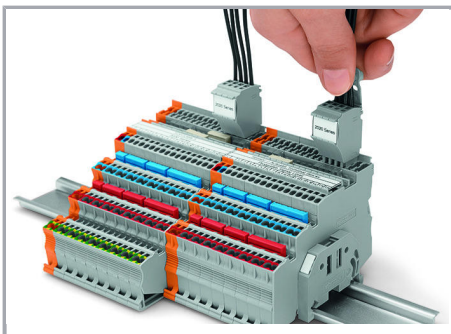

Removing a female plug via conductor bundle provided with strain relief plate.

Marking

Subject to changes. Please also observe the further product documentation!

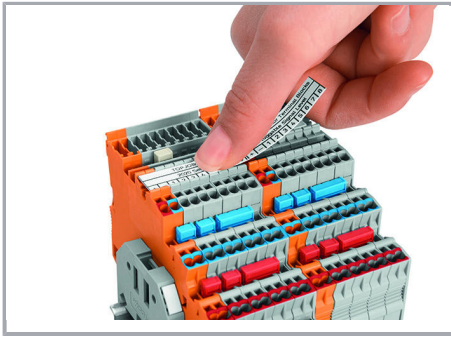

Labeling terminal blocks via marking strips (2009-110) or 3.5 mm wide WMB markers (793-35xx) – from the top or the side.

Product family

TOPJOB® S

TOPJOB® S: In various industrial applications and modern building installations, WAGO's wide and versatile range of rail-mount terminal blocks provides more than just reliable electrical connections.

[Show all products from the family](#)

Subject to changes. Please also observe the further product documentation!